

Product Datasheet - Technical Specifications



More information in our Web-Shop at ► www.meilhaus.com

Your contact

Technical and commercial sales, price information,
quotations, demo/test equipment, consulting:

Tel.: +49 - (0)81 41 - 52 71-0

E-Mail: sales@meilhaus.com

Meilhaus Electronic GmbH
Am Sonnenlicht 2
82239 Alling/Germany

Tel. +49 - (0)81 41 - 52 71-0 E-
Mail sales@meilhaus.com

Mentioned company and product names may be registered trademarks of the respective companies. Errors and omissions excepted. © Meilhaus Electronic.

DT9834 Series

High-Performance Multifunction USB Data Acquisition Modules

Overview

The DT9834 is a series of high-speed, high-performance USB data acquisition (DAQ) modules. These USB DAQ modules are available in a variety of configurations, allowing you to choose the number of analog I/O channels and packaging that suits your application.

The DT9834 Series combines the functionality of multiple boards in a single USB 2.0 module to provide simultaneous analog input, analog output, digital I/O, and counter/timer operations. Available in a number of configurations, the DT9834 Series provides maximum flexibility. All modules feature 16 digital input lines, 16 digital output lines, and 5 counter/timer channels.

Key Features

- Simultaneous subsystem operation: analog input, analog output, digital I/O, counter/timer
- 16 single-ended (SE)/8 differential (DIFF) analog inputs



DT9834 Series modules are available in two configurations: BNC connection box and OEM embedded version.

- 16-bit resolution
- Fast sampling: 500 kS/s
- 32 DIO, 5 counter/timers
- Optional 16-bit deglitched D/A: 500 kS/s/ch for waveform generation
- ± 500 V galvanic isolation protects signal integrity
- OEM or BNC packaging
- Includes free QuickDAQ software to get up and running quickly

Supported Operating Systems

- Windows® 10/8/7/Vista® 32/64-bit

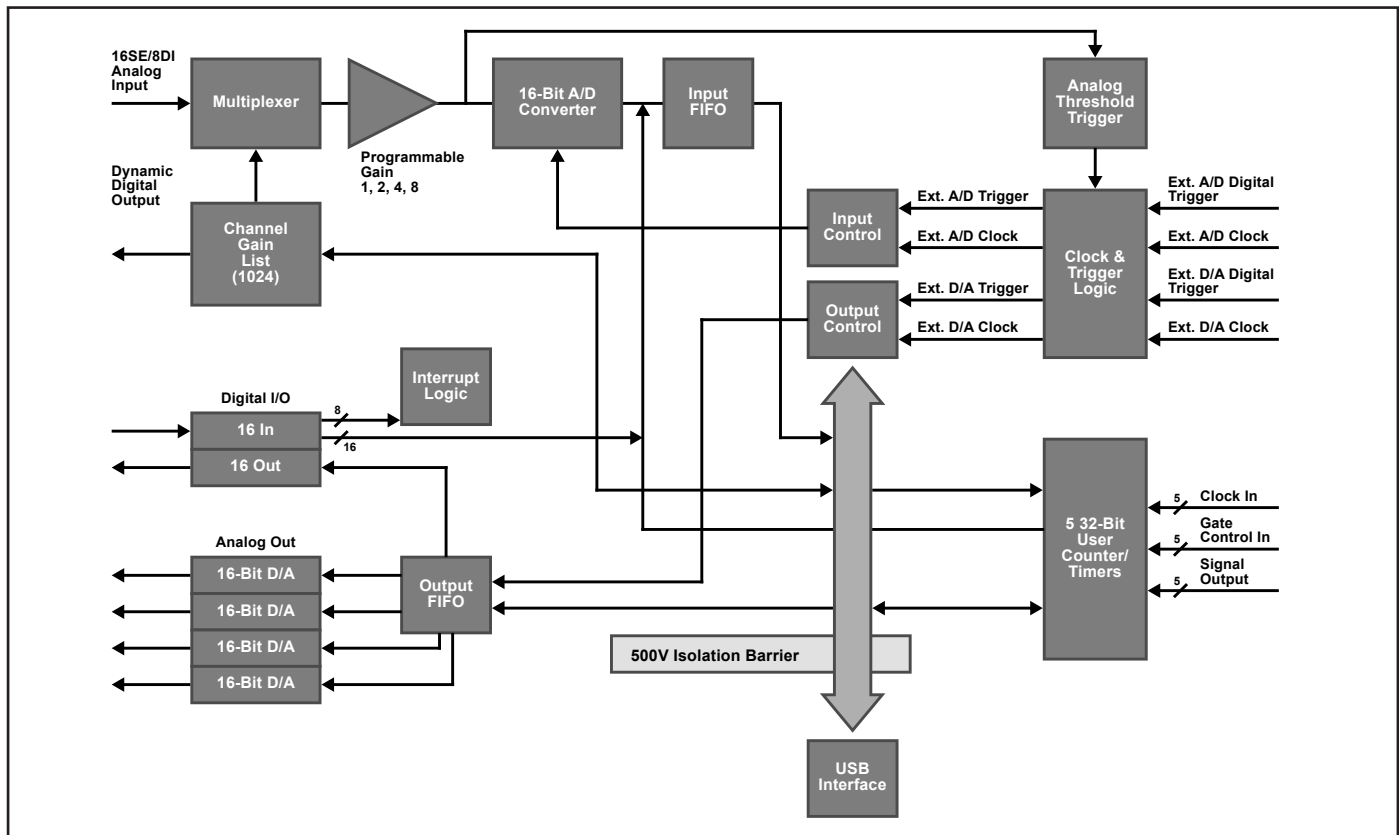

The DT9834 Series provides USB 2.0 multifunction modules for simultaneous A/D, D/A, DIO, and counter/timer subsystem operation. This detailed block diagram shows the relationship of each subsystem and the control signals used in the series. For flexible, cost-effective solutions, you can choose the number of analog I/O channels as well as the packaging configuration that suits your application.

Easy Signal Connections BNC Connection Box

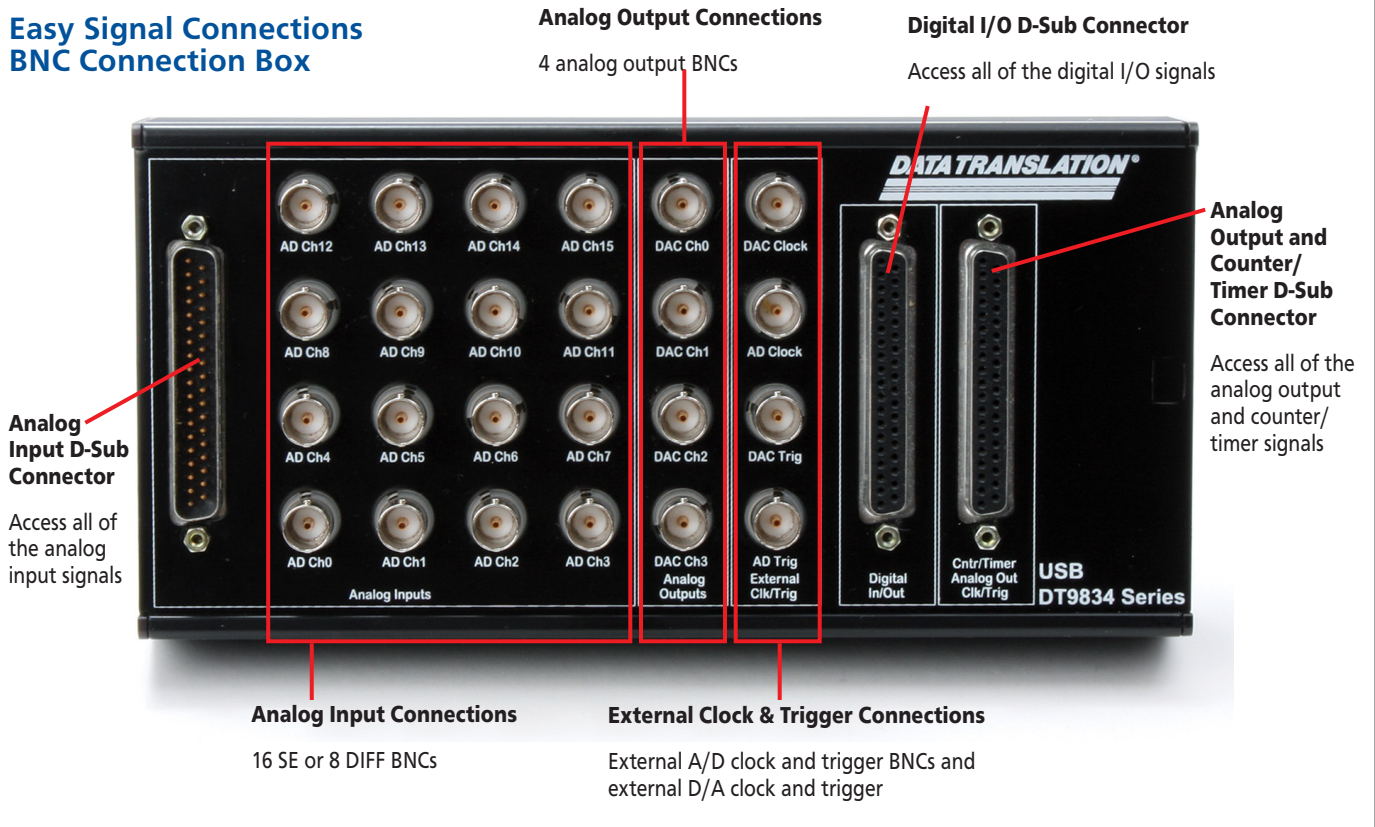

The BNC connection box is available for easy signal connections.

BNC Box Assembly

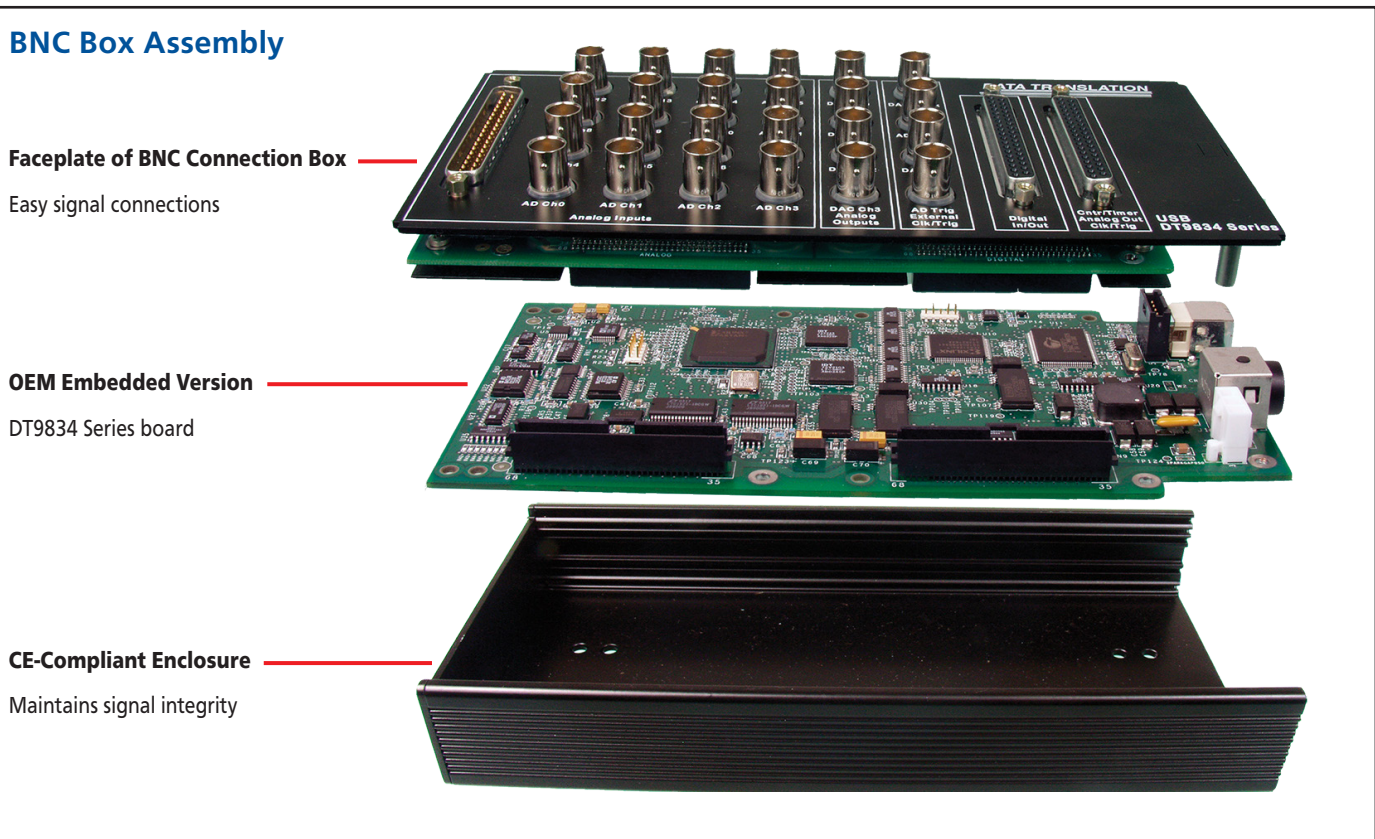

The BNC connection box packages the OEM embedded version of the DT9834 Series in a CE-compliant enclosure.

Uncompromised, High-Integrity Performance OEM Embedded Version

High Throughput

Two-stage instrumentation amplifiers in series maintain high-speed throughput

Clean Signal Connection

16 SE/8 DIFF analog input channels

Ultra Digital I/O

Full digital I/O flexibility for time stamping, pattern recognition, and synchronizing with external events

Full-Featured Counter/Timers

Five 32-bit counter/timers ideal for automotive testing applications

Pure Signal Generation

Four waveform, deglitched DACs

External Control

Flexible clocks and triggers

Flexible Power Connections

+5 V connector; a secondary +5 V connector is provided for embedded applications

Precision Measurements

True 16-bit resolution at 500 kS/s sample rate for measuring dynamic signals

No Limits

Full simultaneous operation of all subsystems

Designed for Low Noise

12-layer PCB provides optimal grounding and shielding to maintain signal integrity

Fully Protected

500 V galvanic isolation protects your computer and maintains signal integrity

High-Speed USB 2.0

USB 2.0 connector; a secondary USB 2.0 connector is provided for embedded applications

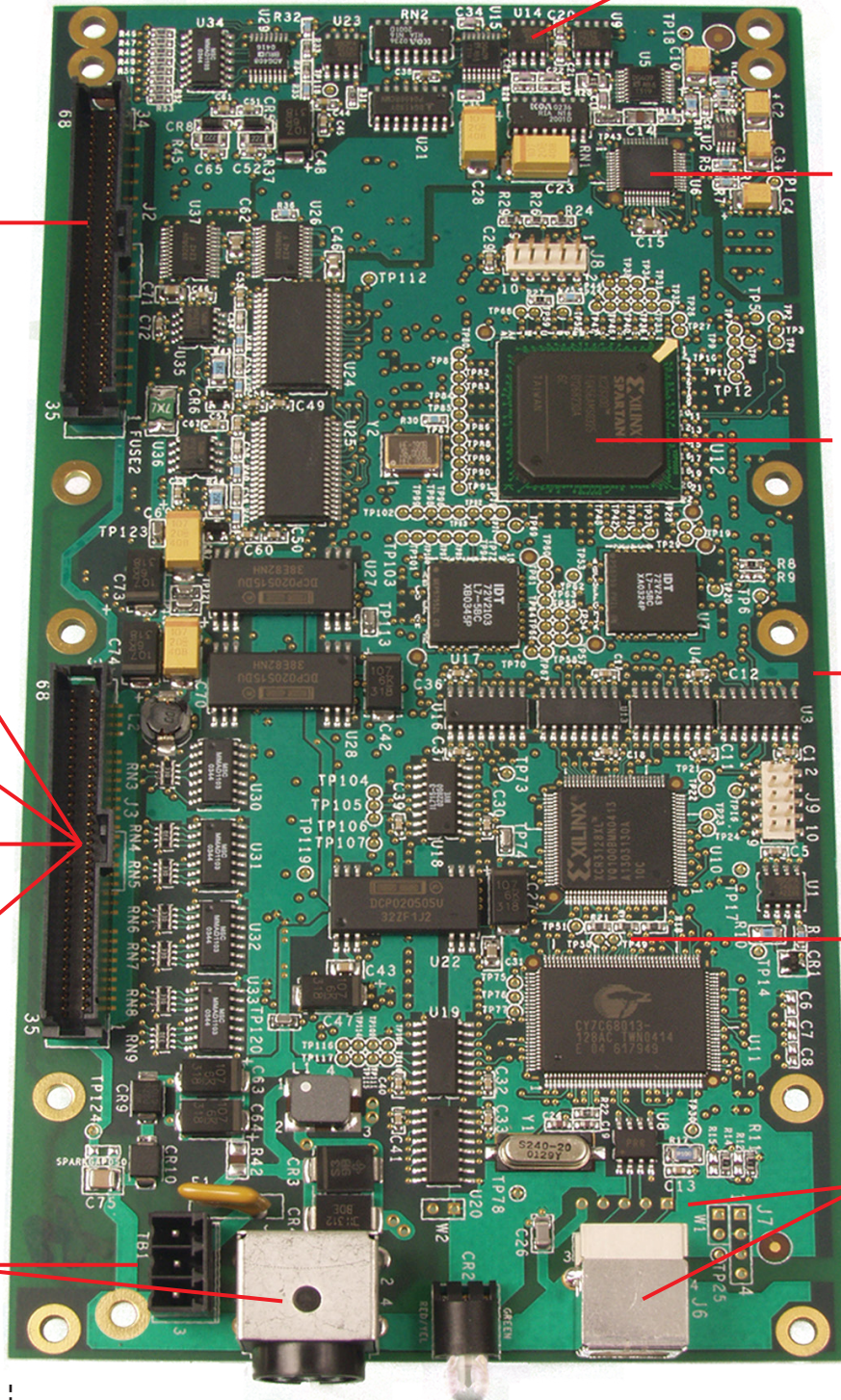

Euro Card Compliance

100 mm size

Screw terminal panels are available for the OEM embedded version.

High-Speed, High-Resolution Analog Inputs

DT9834 Series modules are available in two analog input channel configurations: 16 SE/8 DIFF or 16 SE inputs, or no analog inputs. All analog input signals are multiplexed to a single analog-to-digital converter. All modules feature sample rates up to 500 kS/s with 16-bit resolution.

Four programmable gains (1, 2, 4, and 8) are provided to support input signal ranges of +/- 10 V, +/-5 V, +/-2.5 V, and +/-1.25 V. By configuring each analog input channel for the input range that you want, you can connect many output transducers directly to the module.

Flexible Acquisition Modes

Using the DT9834 Series, you can acquire a single sample from a single analog input channel or multiple samples from multiple analog input channels. A 1024-location channel-gain list gives you the flexibility to sample non-sequential analog input channels, analog input channels with different gains, and digital inputs and counter/timer channels with the analog input channels you want at the A/D sample rate.

DT9834 Series modules provide two ways to cycle through the channel-gain list:

- Continuous scan mode
- Triggered scan mode

High-Speed, High-Resolution Analog Outputs

DT9834 Series modules are available in two analog output channel configurations: 4 deglitched analog output channels, or no analog output channels. Each analog output channel has its own digital-to-analog converter and provides an output signal range of +/- 10 V. You can achieve a maximum update rate of 500 kS/second with 16-bit resolution.

Flexible Output Modes

Using the DT9834 Series, you can output a single value from a single analog output channel or multiple values from multiple analog output channels. An output-channel list gives you the flexibility of updating only the analog output channels you want or updating the digital output lines with specified analog output channels at the D/A clock rate. You can update analog output channels at up to 500 kS/s.

The DT9834 features the following output modes:

- Continuous output mode
- Waveform mode

High-Speed Digital I/O Lines

DT9834 Series modules feature 16 digital input lines and 16 digital output lines. The first eight digital input lines can also be used for interrupt on change. You can read all the digital input lines simultaneously with the analog input channels at the A/D clock rate. The digital input lines can also be clocked separately as the only channel in the channel-gain list at up to 500 kS/second.

Flexible Clocks and Triggers

For maximum flexibility, all DT9834 Series modules provide independent clocks and triggers for the A/D and D/A subsystems. This allows you to trigger and clock the analog output subsystem synchronously with, or independent of, the analog input subsystem. Each subsystem supports an internal clock and external clock input, as well as the following trigger types: software command, analog threshold, and external digital input trigger.

Multifunction Counter/Timers

All DT9834 Series modules feature five 32-bit user counter/timers. If you wish, you can read the value of the counter/timer channels with the analog input channels and digital input lines at the A/D clock rate. The following counter/timer functions are supported: event counting, edge-to-edge measurement, continuous edge-to-edge measurement (for determining the frequency and period width of a signal), continuous pulse output, one-shot, repetitive one-shot, and up/down counting operations. To read the frequency period of a signal as part of the analog input data stream, use continuous edge-to-edge measurement mode.

Programmable gates, clocks, and output signals are also supported.

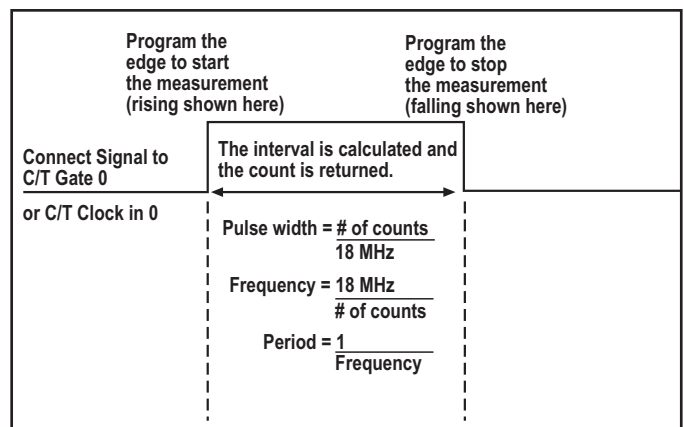

Programmable edges allow you to use counter/timers to measure the pulse width, frequency, and period of signal.

Flexible Packaging Configurations

DT9834 Series modules are available in two packaging configurations: a BNC connection box or an OEM embedded version. The BNC connection box is available with 16 SE channels, 4 BNCs for connecting analog outputs, and 4 BNCs for connecting external clocks and triggers.

The BNC configuration ships with a +5 V galvanically isolated power supply and power cable (EP361), USB 2.0 cable, and Data Acquisition OMNI CD.

The OEM configuration, ideal for embedding in test systems, provides all the functionality of the DT9834 Series in PC-board form. This configuration ships with a USB 2.0 cable and Data Acquisition OMNI CD.

Power

BNC connection boxes include a +5 V power supply and power cable for quick setup. OEMs can purchase these options separately as EP361. A secondary power connector is also provided for OEMs to allow custom power wiring.

±500 V Galvanic Isolation Protects Your Data

Computers are susceptible to ground-spikes through any external port. These spikes can cause system crashes and may even cause permanent damage to your computer. DT9834 Series modules feature 500 Volts of galvanic isolation to protect your computer from ground-spikes and to ensure a reliable stream of data.

Cross-Series Compatibility

Virtually all Data Translation data acquisition modules are compatible with the DT-Open Layers® software standard. This means any application developed with one of Data Translation's software products can easily be upgraded to a new Data Translation module with little to no reprogramming needed.

QuickDAQ

QuickDAQ allows you to acquire and display from all Data Translation USB and Ethernet data acquisition devices that support analog input streaming. Combine QuickDAQ with Data Translation hardware to acquire data, record data to disk, display the results in both a plot and digital display, and read a recorded data file. Be productive right out of the box with this powerful data logging software. Data can be exported to other applications like Microsoft Excel® and The Mathworks MATLAB® for more advanced analysis. Two additional options can be purchased to add FFT analysis capabilities to the base package.

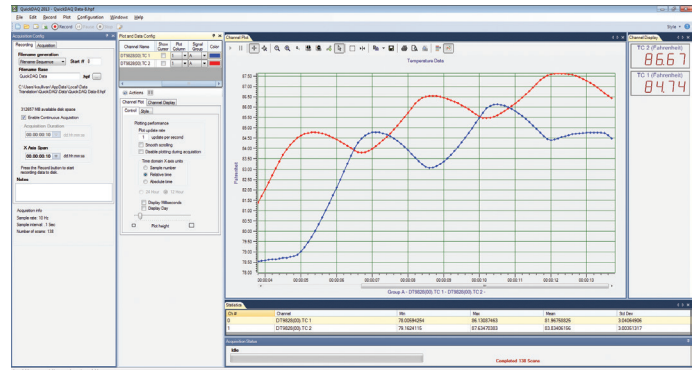

QuickDAQ ships free-of-charge and allows you to get up and running quickly.

Key Features

- **QuickDAQ Base Package (Free)**
 - Ready-to-measure application software
 - Configure, acquire, log, display, and analyze your data
 - Customize many aspects of the acquisition, display, and recording functions to suit your needs
- **FFT Analysis Option (License Required)**
 - Includes all the features of the QuickDAQ Base Package
 - Perform single-channel FFT operations including:
 - ◇ Auto Spectrum
 - ◇ Spectrum
 - ◇ Power Spectral Density
 - Configure and view dynamic performance statistics
 - Supports Hanning, Hamming, Bartlett, Blackman, Blackman Harris, and Flat Top response windows
- **Advanced FFT Analysis Option (License Required)**
 - Includes all the features of the QuickDAQ Base Package and FFT Analysis Package
 - Perform 2-channel FFT operations including:
 - ◇ FRF
 - ◇ Cross-Spectrum
 - ◇ Cross Power Spectral Density
 - ◇ Coherence
 - ◇ Coherent Output Power
 - Supports real, imaginary, and Nyquist display functions
 - Additional FFT analysis functions supported: Exponential, Force, Cosiner Taper
 - Save data to .uff file format

Other Software Options

There are many software choices available for application development, from ready-to-measure applications to programming environments.

The following software is available for use with the DT9834 Series module and is provided on the Data Acquisition Omni CD:

- **Device Driver** – The device driver allows you to use a DT9834 Series module with any of the supported software packages or utilities.
- **Calibration Utility** – This utility allows you to calibrate features of a DT9834 Series module.
- **Quick DataAcq** application – The Quick DataAcq application provides a quick way to get up and running. Using this application, verify key features of the module, display data on the screen, and save data to disk.
- **DT-Open Layers® for .NET Class Library** – Use this class library if you want to use Visual C#® or Visual Basic® for .NET to develop application software using Visual Studio® 2003-2012; the class library complies with the DT-Open Layers standard.
- **DataAcq SDK** – Use the DataAcq SDK to use Visual Studio 6.0 and Microsoft® C or C++ to develop application software using Windows 10/8/7/Vista/XP 32/64-bit; the DataAcq SDK complies with the DT-Open Layers standard.
- **DAQ Adaptor for MATLAB** – Data Translation's DAQ Adaptor provides an interface between the MATLAB® Data Acquisition (DAQ) toolbox from The MathWorks™ and Data Translation's DT-Open Layers architecture.
- **LV-Link** – Data Translation's LV-Link is a library of VIs that enable LabVIEW™ programmers to access the data acquisition features of DT-Open Layers compliant USB and PCI devices.

Accessories for OEM Configurations

For applications where you want to embed a DT9834 Series module inside other equipment, use the OEM packaging configuration (no enclosure) with the following optional accessories:

- **EP355** – This screw terminal panel plugs into connector J2 or J3 of a DT9834 Series module and provides 14-position screw terminal blocks for attaching analog I/O and digital I/O signals.
- **EP361** – A +5 V power supply. It is included with the BNC and STP connection box.

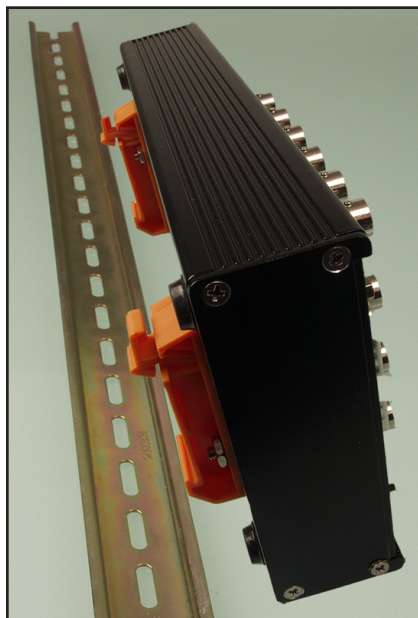

With the optional DIN rail mounting kit (BNC DIN RAIL KIT), you can mount the DT9834 BNC model to a standard DIN rail.

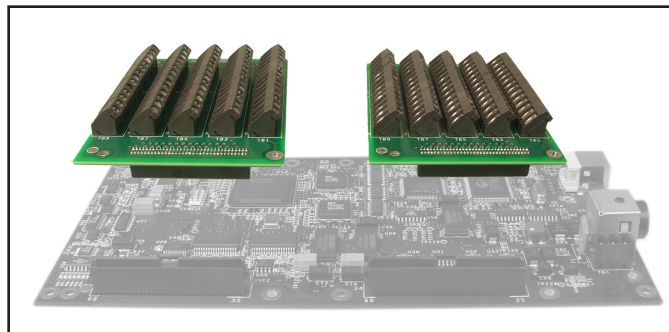

The EP355 screw terminal panel plugs into the J2 or J3 connector of a DT9834 Series module.

Ordering Guide

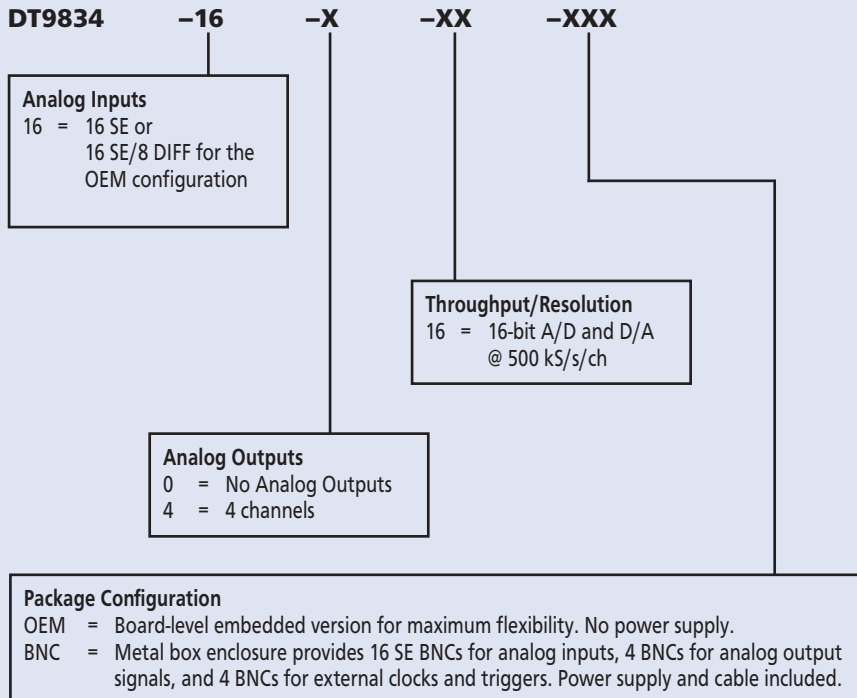

Ordering Summary

ACCESSORIES

- **BNC DIN Rail Kit** – Kit for mounting USB modules in BNC enclosure to a DIN rail. Includes mounting clips, screws, and instructions. DIN Rail not included.
- **EP355** – Screw terminal panel for attaching analog I/O and digital I/O signals (for OEM configurations only).
- **EP361** – A +5 V power supply (included with BNC and STP configurations).

FREE SOFTWARE

- **QuickDAQ**
- **DAQ Adaptor for MATLAB** – Access the analysis and visualization tools of MATLAB®.
- **LV-Link** – Access the power of Data Translation boards through LabVIEW™.

OPTIONAL SOFTWARE

- **QuickDAQ FFT Analysis Option**
(License Required)
- **QuickDAQ Advanced FFT Analysis Option**
(License Required)

Module	Analog In	Analog Out	Resolution	Input Ranges*	Throughput	Digital In	Digital Out	Counters	Packaging
DT9834-16-0-16-OEM	16 SE/8 DIFF	—	16-bit	PGH	500 kS/s	16	16	5	OEM
DT9834-16-4-16-BNC	16 SE	4	16-bit	PGH	500 kS/s	16	16	5	BNC
DT9834-16-4-16-OEM	16 SE/8 DIFF	4	16-bit	PGH	500 kS/s	16	16	5	OEM

*PGH input range: ±10, 5, 2.5, 1.25 volts.