

Product Datasheet - Technical Specifications



More information in our Web-Shop at ► www.meilhaus.com

Your contact

Technical and commercial sales, price information,
quotations, demo/test equipment, consulting:

Tel.: +49 - (0)81 41 - 52 71-0

E-Mail: sales@meilhaus.com

Meilhaus Electronic GmbH
Am Sonnenlicht 2
82239 Alling/Germany

Tel. +49 - (0)81 41 - 52 71-0 E-
Mail sales@meilhaus.com

Mentioned company and product names may be registered trademarks of the respective companies. Errors and omissions excepted. © Meilhaus Electronic.

E4980A Precision LCR Meter

20 Hz to 2 MHz

E4980AL Precision LCR Meter

20 Hz to 300 kHz/500 kHz/1 MHz



Fully compliant to
LXI Class C specification

Table of Contents

Definitions.....	3
How to Use Tables.....	3
E4980A/E4980AL.....	3
Basic Specifications	4
Measurement functions	4
Test signal	5
Measurement display ranges	7
Absolute measurement accuracy	7
Relative accuracy	10
Basic accuracy.....	13
Short offset Z_s	15
Open offset Y_o	16
Calibration accuracy A_{cal}	17
Measurement accuracy	19
Compensation function.....	20
DC bias signal.....	21
Measurement assistance functions	21
Options	22
Frequency options	22
Interface options	23
Other options	23
Power and DC bias enhancement specification.....	23
Test signal	24
DCR measurement specification	29
General Specifications	31
Supplemental Information	35
Settling time	35
Measurement circuit protection	36
Measurement time	36
Display time	39
Measurement data transfer time.....	40
Maximum DC bias current	41
Relative measurement accuracy with bias current isolation	42
DC bias settling time.....	43
Web Resources.....	44

Definitions

All specifications apply to the conditions of a 0 to 55°C temperature range, unless otherwise stated, and 30 minutes after the instrument has been turned on.

Specifications (spec.): Warranted performance. Specifications include guardbands to account for the expected statistical performance distribution, measurement uncertainties, and changes in performance due to environmental conditions.

Supplemental information is provided as information that is useful in operating the instrument but is not covered by the product warranty. This information is classified as either typical or nominal.

Typical (typ.): Expected performance of an average unit without taking guardbands into account.

Nominal (nom.): A general descriptive term that does not imply a level of performance.

How to Use Tables

When measurement conditions fall under multiple categories in a table, apply the best value.

For example, basic accuracy A_b is 0.10% under the following conditions:

Measurement time mode	SHORT
Test frequency	125 Hz
Test signal voltage	0.3 Vrms

E4980A/E4980AL

The E4980A is the model number of the 20 Hz to 2 MHz frequency range LCR meter. The E4980AL is the model number of the 20 Hz to 300 kHz, 500 kHz or 1 MHz frequency range LCR meter. See the E4980A/E4980AL Configuration Guide (5989-8321EN) for more details.

Frequency range	Model number and option
20 Hz to 2 MHz	E4980A
20 Hz to 1 MHz	E4980AL-102
20 Hz to 500 kHz	E4980AL-052
20 Hz to 300 kHz	E4980AL-032

Basic Specifications

Measurement functions

Measurement parameters

- Cp-D, Cp-Q, Cp-G, Cp-Rp
- Cs-D, Cs-Q, Cs-Rs
- Lp-D, Lp-Q, Lp-G, Lp-Rp, Lp-Rdc
- Ls-D, Ls-Q, Ls-Rs, Ls-Rdc
- R-X
- Z- θ d, Z- θ r
- G-B
- Y- θ d, Y- θ r
- Vdc-Idc¹

Definitions

Cp	Capacitance value measured with parallel-equivalent circuit model
Cs	Capacitance value measured with series-equivalent circuit model
Lp	Inductance value measured with parallel-equivalent circuit model
Ls	Inductance value measured with series-equivalent circuit model
D	Dissipation factor
Q	Quality factor (inverse of D)
G	Equivalent parallel conductance measured with parallel-equivalent circuit model
Rp	Equivalent parallel resistance measured with parallel-equivalent circuit model
Rs	Equivalent series resistance measured with series-equivalent circuit model
Rdc	Direct-current resistance
R	Resistance
X	Reactance
Z	Impedance
Y	Admittance
θd	Phase angle of impedance/admittance (degree)
θr	Phase angle of impedance/admittance (radian)
B	Susceptance
Vdc	Direct-current voltage
Idc	Direct-current electricity

Deviation measurement function: Deviation from reference value and percentage of deviation from reference value can be output as the result.

Equivalent circuits for measurement: Parallel, Series

1. E4980A-001 is required.

Impedance range selection: Auto (auto range mode), manual (hold range mode)

Trigger mode: Internal trigger (INT), manual trigger (MAN), external trigger (EXT), GPIB trigger (BUS)

Table 1. Trigger delay time

Range	0 s - 999 s
Resolution	100 μ s (0 s \leq - \leq 100 s) 1 ms (100 s < - \leq 999 s)

Table 2. Step delay time

Range	0 s - 999 s
Resolution	100 μ s (0 s \leq - \leq 100 s) 1 ms (100 s < - \leq 999 s)

Measurement terminal: Four-terminal pair

Test cable length: 0 m, 1 m, 2 m, 4 m

Measurement time modes: Short mode, medium mode, long mode.

Table 3. Averaging

Range	1 - 256 measurements
Resolution	1

Test signal

Table 4. Test frequencies

Test frequencies	20 Hz - 2 MHz (E4980A) 20 Hz - 1 MHz (E4980AL-102) 20 Hz - 500 kHz (E4980AL-052) 20 Hz - 300 kHz (E4980AL-032)
Resolution	0.01 Hz (20 Hz - 99.99 Hz) 0.1 Hz (100 Hz - 999.9 Hz) 1 Hz (1 kHz - 9.999 kHz) 10 Hz (10 kHz - 99.99 kHz) 100 Hz (100 kHz - 999.9 kHz) 1 kHz (1 MHz - 2 MHz)
Measurement accuracy	$\pm 0.01\%$

Table 5. Test signal modes

Normal	Program selected voltage or current at the measurement terminals when they are opened or short-circuited, respectively.
Constant	Maintains selected voltage or current at the device under test (DUT) independently of changes in impedance of DUT.

Signal level

Table 6. Test signal voltage

Range		0 Vrms - 2.0 Vrms	
Resolution		100 μ Vrms (0 Vrms \leq - \leq 0.2 Vrms) 200 μ Vrms (0.2 Vrms < - \leq 0.5 Vrms) 500 μ Vrms (0.5 Vrms < - \leq 1 Vrms) 1 mVrms (1 Vrms < - \leq 2 Vrms)	
Accuracy	Normal	\pm (10% + 1 mVrms)	Test frequency \leq 1 MHz: spec. Test frequency > 1 MHz: typ.
	Constant ¹	\pm (6% + 1 mVrms)	Test frequency \leq 1 MHz: spec. Test frequency > 1 MHz: typ.

Table 7. Test signal current

Range		0 Arms - 20 mArms	
Resolution		1 μ Arms (0 Arms \leq - \leq 2 mArms) 2 μ Arms (2 mArms < - \leq 5 mArms) 5 μ Arms (5 mArms < - \leq 10 mArms) 10 μ Arms (10 mArms < - \leq 20 mArms)	
Accuracy	Normal	\pm (10% + 10 μ Arms)	Test frequency \leq 1 MHz: spec. Test frequency > 1 MHz: typ.
	Constant ¹	\pm (6% + 10 μ Arms)	Test frequency \leq 1 MHz: spec. Test frequency > 1 MHz: typ.

Output impedance: 100 Ω (nominal)

Test signal level monitor function

- Test signal voltage and test signal current can be monitored.
- Level monitor accuracy (see next page)

1. When auto level control function is on.

Table 8. Test signal voltage monitor accuracy (Vac)

Test signal voltage ²	Test frequency	Specification
5 mVrms - 2 Vrms	\leq 1 MHz > 1 MHz	\pm (3% of reading value + 0.5 mVrms) \pm 6% of reading value + 1 mVrms)

Table 9. Test signal current monitor accuracy (Iac)

Test signal current ²	Test frequency	Specification
50 μ Arms - 20 mArms	\leq 1 MHz > 1 MHz	\pm (3% of reading value + 5 μ Arms) \pm (6% of reading value + 10 μ Arms)

Measurement display ranges

Table 10 shows the range of measured value that can be displayed on the screen. For the effective measurement ranges, refer to Figure 1 impedance measurement accuracy example.

Table 10. Allowable display ranges for measured values

Parameter	Measurement display range
Cs, Cp	± 1.000000 aF to 999.9999 EF
Ls, Lp	±1.000000 aH to 999.9999 EH
D	±0.000001 to 9.999999
Q	±0.01 to 99999.99
R, Rs, Rp, X, Z, Rdc	±1.000000 aΩ to 999.9999 EΩ
G, B, Y	±1.000000 aS to 999.9999 ES
Vdc	±1.000000 aV to 999.9999 EV
Idc	±1.000000 aA to 999.9999 EA
θr	±1.000000 arad to 3.141593 rad
θd	±0.0001 deg to 180.0000 deg
Δ%	±0.0001% to 999.9999%

a: 1×10^{-18} , E: 1×10^{18}

1. When auto level control function is on.
2. This is not an output value but rather a displayed test signal level.

Absolute measurement accuracy

The following equations are used to calculate absolute accuracy.

Absolute accuracy Aa of |Z|, |Y|, L, C, R, X, G, B (L, C, X, and B accuracies apply when $D_x \leq 0.1$, R and G accuracies apply when $Q_x \leq 0.1$)

When $D_x \geq 0.1$, multiply Acal by $\sqrt{1 + D_x^2}$ for L, C, X, and B accuracies

When $Q_x \geq 0.1$, multiply Acal by $\sqrt{1 + Q_x^2}$ for R and G accuracies

Under an AC magnetic field, the following equation is applied to the measurement accuracy.

$$A \times (1 + B \times (2 + 0.5 / V_s))$$

Where A Absolute accuracy
 B Magnetic flux density [Gauss]
 Vs Test signal voltage level [Volts]

Equation 1. $Aa = Ae + Acal$

Aa Absolute accuracy (% of reading value)

Ae Relative accuracy (% of reading value)

Acal Calibration accuracy (%)

where G accuracy is applied only to G-B measurements.

D accuracy (when $Dx \leq 0.1$)

Equation 2. $De + \theta cal$

Dx Measured D value

De Relative accuracy of D

θcal Calibration accuracy of θ (radian)

when $0.1 < Dx \leq 1$, multiply θcal by $(1 + Dx)$

Q accuracy (When $Qx \times Da < 1$)¹

Equation 3.
$$\pm \frac{(Qx^2 \times Da)}{(1 \mp Qx \times Da)}$$

Qx Measured Q value

Da Absolute accuracy of D

¹ When $Qx \times Da \geq 1$, Q accuracy = $\pm \infty$

θ accuracy

Equation 4. $\theta_e + \theta_{cal}$

θ_e Relative accuracy of θ (degree)
 θ_{cal} Calibration accuracy of θ (degree)

G accuracy (when $D_x \leq 0.1$)

Equation 5. $B_x + Da$ (S)
$$B_x = 2\pi f C_x = \frac{1}{2\pi f L_x}$$

D_x Measured D value
 B_x Measured B value (S)
 Da Absolute accuracy of D
 f Test frequency (Hz)
 C_x Measured C value (F)
 L_x Measured L value (H)

where the accuracy of G is applied to Cp-G measurements.

Absolute accuracy of Rp (when $D_x \leq 0.1$ and $D_x > Da$)¹

Equation 6.
$$\pm \frac{R_{px} \times Da}{D_x \mp Da} (\Omega)$$

R_{px} Measured Rp value (Ω)
 D_x Measured D value
 Da Absolute accuracy of D

Absolute accuracy of Rs (when $D_x \leq 0.1$)

Equation 7. $X_x \times Da$ (Ω)
$$X_x = \frac{1}{2\pi f C_x} = 2\pi f L_x$$

D_x Measured D value
 X_x Measured X value (Ω)
 Da Absolute accuracy of D
 f Test frequency (Hz)
 C_x Measured C value (F)
 L_x Measured L value (H)

¹ When $D_x \leq Da$, Rp accuracy = $\pm \infty$

Relative accuracy

Relative accuracy includes stability, temperature coefficient, linearity, repeatability, and calibration interpolation error. Relative accuracy is specified when all of the following conditions are satisfied:

- Warm-up time: 30 minutes
- Test cable length: 0 m, 1 m, 2 m, or 4 m (Keysight Technologies, Inc. 16048A/D/E)
- A “Signal Source Overload” warning does not appear. When the test signal current exceeds a value in table 11 below, a “Signal Source Overload” warning appears.

Table 11.

Test signal voltage	Test frequency	Condition ¹
≤ 2 Vrms	–	–
> 2 Vrms	≤ 1 MHz	The smaller value of either 110 mA or 130 mA - 0.0015 × Vac × (Fm / 1 MHz) × (L_cable + 0.5)
	> 1 MHz	70 mA - 0.0015 × Vac × (Fm / 1 MHz) × (L_cable + 0.5)

1. When the calculation result is a negative value, 0 A is applied.

Vac [V] Test signal voltage
Fm [Hz] Test frequency
L_cable [m] Cable length

- OPEN and SHORT corrections have been performed.
- Bias current isolation: Off
- The DC bias current does not exceed a set value within each range of the DC bias current
- The optimum impedance range is selected by matching the impedance of DUT to the effective measuring range.

|Z|, |Y|, L, C, R, X, G, and B accuracy (L, C, X, and B accuracies apply when $D_x \leq 0.1$, R and G accuracies apply $Q_x \leq 0.1$)

When $D_x > 0.1$, multiply A_e by $\sqrt{1+D_x^2}$ for L, C, X, and B accuracies

When $Q_x > 0.1$, multiply A_e by $\sqrt{1+Q_x^2}$ for R and G accuracies

Relative accuracy A_e is given as:

Equation 8. $A_e = [A_b + Z_s / |Z_m| \times 100 + Y_o \times |Z_m| \times 100] \times K_t$

Z_m Impedance of DUT
 A_b Basic accuracy
 Z_s Short offset
 Y_o Open offset
 K_t Temperature coefficient

D accuracy

D accuracy D_e is given as - when $D_x \leq 0.1$

Equation 9. $D_e = \pm A_e / 100$

D_x Measured D value
 A_e Relative accuracies of $|Z|$, $|Y|$, L, C, R, X, G, and B

When $0.1 < D_x \leq 1$, multiply D_e by $(1 + D_x)$

Q accuracy (when $Q \times D_e < 1$)¹

Q accuracy Q_e is given as:

Equation 10.
$$Q_e = \pm \frac{(Q_x^2 \times D_e)}{(1 \mp Q_x \times D_e)}$$

Q_x Measured Q value
 D_e Relative D accuracy

θ accuracy

θ accuracy θ_e is given as:

Equation 11.
$$\theta_e = \frac{180 \times A_e}{\pi \times 100} \text{ (deg)}$$

A_e Relative accuracies of $|Z|$, $|Y|$, L, C, R, X, G, and B

1. When $Q_x \times D_e \geq 1$, $Q_e = \pm \infty$

G accuracy (when $Dx \leq 0.1$)

G accuracy Ge is given as:

Equation 12. $Ge = Bx \times De$ (S)

$$Bx = 2\pi fCx = \frac{1}{2\pi fLx}$$

Ge	Relative G accuracy
Dx	Measured D value
Bx	Measured B value
De	Relative D accuracy
f	Test frequency (Hz)
Cx	Measured C value (F)
Lx	Measured L value (H)

Rp accuracy (when $Dx \leq 0.1$ and $Dx > De$)¹

Rp accuracy Rpe is given as:

Equation 13. $Rpe = \pm \frac{Rpx \times De}{Dx \mp De}$ (Ω)

Rpe	Relative Rp accuracy
Rpx	Measured Rp value (Ω)
Dx	Measured D value
De	Relative D accuracy

Rs accuracy (when $Dx \leq 0.1$)

Rs accuracy Rse is given as:

Equation 14. $Rse = Xx \times De$ (Ω)

$$Xx = \frac{1}{2\pi fCx} = 2\pi fLx$$

Rse	Relative Rs accuracy
Dx	Measured D value
Xx	Measured X value (Ω)
De	Relative D accuracy
f	Test frequency (Hz)
Cx	Measured C value (F)
Lx	Measured L value (H)

1. When $Dx \leq De$, $Rpe = \pm \infty$

Example of C-D accuracy calculation

Measurement conditions

Test frequency: 1 kHz
Measured C value: 100 nF
Test signal voltage: 1 Vrms
Measurement time mode: Medium
Measurement temperature: 23°C

$$A_b = 0.05\%$$

$$|Z_m| = 1 / (2\pi \times 1 \times 10^3 \times 100 \times 10^{-9}) = 1590 \Omega$$

$$Z_s = 0.6 \text{ m}\Omega \times (1 + 0.400/1) \times (1 + \sqrt{(1000/1000)}) = 1.68 \text{ m}\Omega$$

$$Y_o = 0.5 \text{ nS} \times (1 + 0.100/1) \times (1 + \sqrt{(100/1000)}) = 0.72 \text{ nS}$$

$$\text{C accuracy: } A_e = [0.05 + 1.68 \text{ m}/1590 \times 100 + 0.72 \text{ n} \times 1590 \times 100] \times 1 = 0.05\%$$

$$\text{D accuracy: } D_e = 0.05/100 = 0.0005$$

Basic accuracy

Basic accuracy A_b is given from Table 12, 13, 14 and 15.

Table 12. Measurement time mode = SHORT

Test frequency [Hz]	Test signal voltage				
	5 mVrms ≤ - < 50 mVrms	50 mVrms ≤ - < 0.3 Vrms	0.3 Vrms ≤ - ≤ 1 Vrms	1 Vrms < - ≤ 10 Vrms	10 Vrms < - ≤ 20 Vrms
20 ≤ - < 125	(0.6%) × (50 mVrms/Vs)	0.60%	0.30%	0.30%	0.30%
125 ≤ - ≤ 1 M	(0.2%) × (50 mVrms/Vs)	0.20%	0.10%	0.15%	0.15%
1 M < - ≤ 2 M	(0.4%) × (50 mVrms/Vs)	0.40%	0.20%	0.30%	0.30%

Table 13. Measurement time mode = MED, LONG

Test frequency [Hz]	Test signal voltage				
	5 mVrms ≤ - < 30 mVrms	30 mVrms ≤ - < 0.3 Vrms	0.3 Vrms ≤ - ≤ 1 Vrms	1 Vrms < - ≤ 10 Vrms	10 Vrms < - ≤ 20 Vrms
20 ≤ - < 100	(0.25%) × (30 mVrms/Vs)	0.25%	0.10%	0.15%	0.15%
100 ≤ - ≤ 1 M	(0.1%) × (30 mVrms/Vs)	0.10%	0.05%	0.10%	0.15%
1 M < - ≤ 2 M	(0.2%) × (30 mVrms/Vs)	0.20%	0.10%	0.20%	0.30%

Vs [Vrms] Test signal voltage

Effect by impedance of DUT

Table 14. For impedance of DUT below 30 Ω, the following value is added.

Test frequency [Hz]	Impedance of DUT	
	1.08 Ω ≤ Zx < 30 Ω	Zx < 1.08 Ω
20 ≤ - ≤ 1 M	0.05%	0.10%
1 M < - ≤ 2 M	0.10%	0.20%

Table 15. For impedance of DUT over 9.2 k Ω, the following value is added.

Test frequency [Hz]	Impedance of DUT	
	9.2 kΩ < Zx ≤ 92 kΩ	92 kΩ < Zx
10 k ≤ - ≤ 100 k	0%	0.05%
100 k < - ≤ 1 M	0.05%	0.05%
1 M < - ≤ 2 M	0.10%	0.10%

Effect of cable extension

When the cable is extended, the following element is added per one meter.

$$0.015 \% \times (Fm/1 \text{ MHz})^2 \times (L_{\text{cable}})^2$$

Fm [Hz] Test frequency

L_cable [m] Cable length

Short offset Zs

Table 16. Impedance of DUT > 1.08 Ω

Test frequency [Hz]	Measurement time mode	
	SHORT	MED, LONG
20 - 2 M	$2.5 \text{ m}\Omega \times (1 + 0.400/V_s) \times (1 + \sqrt{(1000/F_m)})$	$0.6 \text{ m}\Omega \times (1 + 0.400/V_s) \times (1 + \sqrt{(1000/F_m)})$

Table 17. Impedance of DUT ≤ 1.08 Ω

Test frequency [Hz]	Measurement time mode	
	SHORT	MED, LONG
20 - 2 M	$1 \text{ m}\Omega \times (1 + 1/V_s) \times (1 + \sqrt{(1000/F_m)})$	$0.2 \text{ m}\Omega \times (1 + 1/V_s) \times (1 + \sqrt{(1000/F_m)})$

Vs [Vrms] Test signal voltage

Fm [Hz] Test frequency

Effect of cable extension (Short offset)

Table 18. When the cable is extended, the following value is added to Zs (independent of the measurement time mode).

Test frequency [Hz]	Cable length			
	0 m	1 m	2 m	4 m
20 ≤ - ≤ 1 M	0	0.25 mΩ	0.5 mΩ	1 mΩ
1 M < - ≤ 2 M	0	1 mΩ	2 mΩ	4 mΩ

Open offset Y_o

Table 19. Test signal voltage ≤ 2.0 Vrms

Test frequency [Hz]	Measurement time mode	
	SHORT	MED, LONG
$20 \leq - \leq 100$ k	$2 \text{ nS} \times (1 + 0.100/V_s) \times (1 + \sqrt{(100/F_m)})$	$0.5 \text{ nS} \times (1 + 0.100/V_s) \times (1 + \sqrt{(100/F_m)})$
$100 \text{ k} < - \leq 1$ M	$20 \text{ nS} \times (1 + 0.100/V_s)$	$5 \text{ nS} \times (1 + 0.100/V_s)$
$1 \text{ M} < - \leq 2$ M	$40 \text{ nS} \times (1 + 0.100/V_s)$	$10 \text{ nS} \times (1 + 0.100/V_s)$

Table 20. Test signal voltage > 2.0 Vrms

Test frequency [Hz]	Measurement time mode	
	SHORT	MED, LONG
$20 \leq - \leq 100$ k	$2 \text{ nS} \times (1 + 2/V_s) \times (1 + \sqrt{(100/F_m)})$	$0.5 \text{ nS} \times (1 + 2/V_s) \times (1 + \sqrt{(100/F_m)})$
$100 \text{ k} < - \leq 1$ M	$20 \text{ nS} \times (1 + 2/V_s)$	$5 \text{ nS} \times (1 + 2/V_s)$
$1 \text{ M} < - \leq 2$ M	$40 \text{ nS} \times (1 + 2/V_s)$	$10 \text{ nS} \times (1 + 2/V_s)$

V_s [Vrms] Test signal voltage
 F_m [Hz] Test frequency

Note

The Open Offset may become three times greater in the ranges of 40 to 70 kHz and 80 to 100 kHz due to residual response.

Effect of cable length

Table 21. When the cable is extended, multiply Y_o by the following factor.

Test frequency [Hz]	Cable length			
	0 m	1 m	2 m	4 m
$100 \leq - < 100$ k	1	$1 + 5 \times F_m/1 \text{ MHz}$	$1 + 10 \times F_m/1 \text{ MHz}$	$1 + 20 \times F_m/1 \text{ MHz}$
$100 \text{ k} \leq - \leq 1$ M	1	$1 + 0.5 \times F_m/1 \text{ MHz}$	$1 + 1 \times F_m/1 \text{ MHz}$	$1 + 2 \times F_m/1 \text{ MHz}$
$1 \text{ M} < - \leq 2$ M	1	$1 + 1 \times F_m/1 \text{ MHz}$	$1 + 2 \times F_m/1 \text{ MHz}$	$1 + 4 \times F_m/1 \text{ MHz}$

F_m [Hz] Test frequency

Temperature factor Kt

Table 22. Temperature factor Kt.

Temperature [°C]	Kt
$0 \leq - < 18$	4
$18 \leq - \leq 28$	1
$28 < - \leq 55$	4

Calibration accuracy Acal

Calibration accuracy Acal is given below.

For impedance of DUT or test frequency on the boundary line, apply the smaller value.

Table 23. Impedance range = 0.1, 1, 10 Ω

	Test frequency [Hz]					
	20 – 1 k	1 k – 10 k	10 k – 100 k	100 k – 300 k	300 k – 1 M	1 M – 2 M
Z [%]	0.03	0.05	0.05	$0.05 + 5 \times 10^{-5} F_m$	$0.05 + 5 \times 10^{-5} F_m$	$0.1 + 1 \times 10^{-4} F_m$
θ [radian]	1×10^{-4}	2×10^{-4}	3×10^{-4}	$3 \times 10^{-4} + 2 \times 10^{-7} F_m$	$3 \times 10^{-4} + 2 \times 10^{-7} F_m$	$6 \times 10^{-4} + 4 \times 10^{-7} F_m$

Table 24. Impedance range = 100 Ω

	Test frequency [Hz]					
	20 – 1 k	1 k – 10 k	10 k – 100 k	100 k – 300 k	300 k – 1 M	1 M – 2 M
Z [%]	0.03	0.05	0.05	$0.05 + 5 \times 10^{-5} F_m$	$0.05 + 5 \times 10^{-5} F_m$	$0.1 + 1 \times 10^{-4} F_m$
θ [radian]	1×10^{-4}	2×10^{-4}	3×10^{-4}	3×10^{-4}	3×10^{-4}	6×10^{-4}

Table 25. Impedance range = 300, 1 kΩ

	Test frequency [Hz]					
	20 – 1 k	1 k – 10 k	10 k – 100 k	100 k – 300 k	300 k – 1 M	1 M – 2 M
Z [%]	0.03	0.03	0.05	0.05	0.05	0.1
θ [radian]	1×10^{-4}	1×10^{-4}	3×10^{-4}	3×10^{-4}	3×10^{-4}	6×10^{-4}

Table 26. Impedance range = 3 k, 10 kΩ

	Test frequency [Hz]					
	20 – 1 k	1 k – 10 k	10 k – 100 k	100 k – 300 k	300 k – 1 M	1 M – 2 M
Z [%]	0.03 + $1 \times 10^{-4} F_m$	0.03 + $1 \times 10^{-4} F_m$	0.03 + $1 \times 10^{-4} F_m$	0.03 + $1 \times 10^{-4} F_m$	0.03 + $1 \times 10^{-4} F_m$	0.06 + $2 \times 10^{-4} F_m$
θ [radian]	$(100 + 2.5 F_m) \times 10^{-6}$	$(100 + 2.5 F_m) \times 10^{-6}$	$(100 + 2.5 F_m) \times 10^{-6}$	$(100 + 2.5 F_m) \times 10^{-6}$	$(100 + 2.5 F_m) \times 10^{-6}$	$(200 + 5 F_m) \times 10^{-6}$

Table 27. Impedance range = 30 k, 100 kΩ

	Test frequency [Hz]					
	20 – 1 k	1 k – 10 k	10 k – 100 k	100 k – 300 k	300 k – 1 M	1 M – 2 M
Z [%]	0.03 + $1 \times 10^{-3} F_m$	0.03 + $1 \times 10^{-3} F_m$	0.03 + $1 \times 10^{-3} F_m$	0.03 + $1 \times 10^{-3} F_m$	0.03 + $1 \times 10^{-4} F_m$	0.06 + $2 \times 10^{-4} F_m$
θ [radian]	$(100 + 20 F_m) \times 10^{-6}$	$(100 + 20 F_m) \times 10^{-6}$	$(100 + 20 F_m) \times 10^{-6}$	$(100 + 20 F_m) \times 10^{-6}$	$(100 + 2.5 F_m) \times 10^{-6}$	$(200 + 5 F_m) \times 10^{-6}$

Fm[kHz] Test frequency

Measurement accuracy

The impedance measurement calculation example below is the result of absolute measurement accuracy.

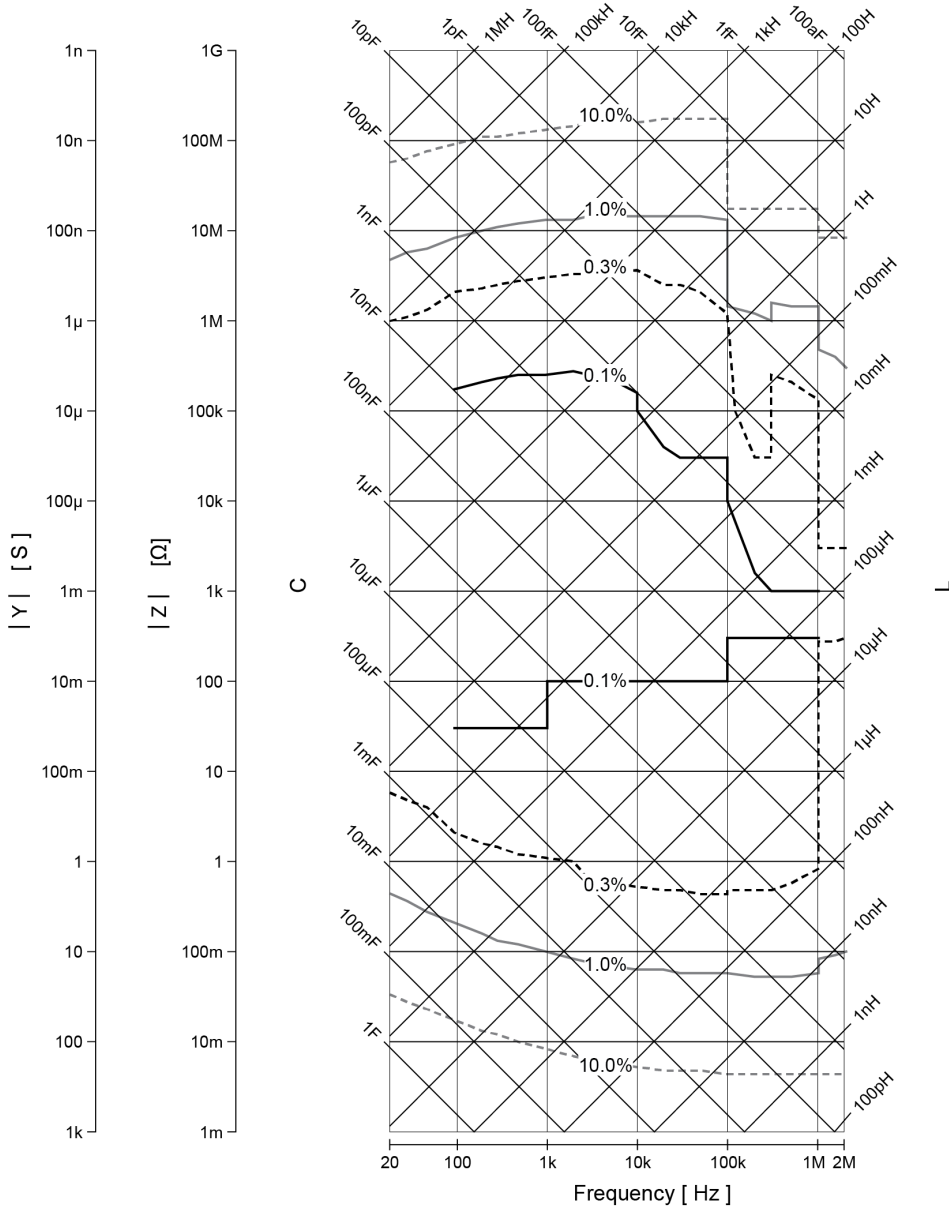

Figure 1. Impedance measurement accuracy (Test signal voltage = 1 Vrms, cable length = 0 m, measurement time mode = MED)

Compensation function

Table 28. The E4980A/E4980AL provides three types of compensation functions: OPEN compensation, SHORT compensation, and LOAD compensation.

Type of compensation	Description
OPEN compensation	Compensates errors caused by the stray admittance (C, G) of the test fixture.
SHORT compensation	Compensates errors caused by the residual impedance (L, R) of the test fixture.
LOAD compensation	Compensates errors between the actual measured value and a known standard value under the measurement conditions desired by the user.

List sweep

Points: There is a maximum of 201 points.

First sweep parameter (primary parameter): Test frequency, test signal voltage, test signal current, test signal voltage of DC bias signal, test signal current of DC bias signal, DC source voltage.

Second sweep parameter (secondary parameter): None, impedance range, test frequency, test signal voltage, test signal current, test signal voltage of DC bias signal, test signal current of DC bias signal, DC source voltage

Note

A parameter selected for one of the two parameters cannot be selected for the other parameter. It is not possible to set up a combination of test signal voltage and test signal current or one of test signal voltage of DC bias signal and test signal current of DC bias.
The secondary parameter can be set only with SCPI commands.

Trigger mode

Sequential mode: When the E4980A/E4980AL is triggered once, the device is measured at all sweep points. /EOM/INDEX is output only once.

Step mode: The sweep point is incremented each time the E4980A/E4980AL is triggered. /EOM/INDEX is output at each point, but the result of the comparator function of the list sweep is available only after the last /EOM is output.

Comparator function of list sweep: The comparator function enables setting one pair of lower and upper limits for each measurement point.

You can select from: Judge with the first sweep parameter/Judge with the second parameter/Not used for each pair of limits.

Time stamp function: In the sequential mode, it is possible to record the measurement starting time at each measurement point by defining the time when FW detects a trigger as 0 and obtain it later with the SCPI command.

Comparator function

Bin sort: The primary parameter can be sorted into 9 BINS, OUT_OF_BINS, AUX_BIN, and LOW_C_REJECT. The secondary parameter can be sorted into HIGH, IN, and LOW. The sequential mode and tolerance mode can be selected as the sorting mode.

Limit setup: Absolute value, deviation value, and % deviation value can be used for setup.

BIN count: Countable from 0 to 999999.

DC bias signal

Table 29. Test signal voltage

Range	0 V to +2 V
Resolution	0 V / 1.5 V / 2 V only
Accuracy	0.1% + 2 mV (23°C ± 5°C) (0.1% + 2 mV) × 4 (0 to 18°C or 28 to 55°C)

Output impedance: 100 Ω (nominal)

Measurement assistance functions

Data buffer function: Up to 201 measurement results can be read out in a batch.

Save/Recall function:

- Up to 10 setup conditions can be written to/read from the built-in non-volatile memory.
- Up to 10 setup conditions can be written to/read from the USB memory.
- Auto recall function can be performed when the setting conditions are written to Register 10 of the USB memory.

Key lock function: The front panel keys can be locked.

GPIO: 24-pin D-Sub (Type D-24), female; complies with IEEE488.1, 2 and SCPI

USB host port: Universal serial bus jack, type-A (4 contact positions, contact 1 is on your left), female (for connection to USB memory only).

USB interface port: Universal serial bus jack, type mini-B (4 contact positions); complies with USBTMC-USB488 and USB 2.0; female; for connection to the external controller.

USBTMC: Abbreviation for USB Test & Measurement Class

LAN: 10/100 BaseT Ethernet, 8 pins (two speed options)

LXI Compliance: Class C (only applies to units with firmware revision A.02.00 or later)

Options

Frequency options

E4980A	20 Hz to 2 MHz
E4980AL-032	20 Hz to 300 kHz
E4980AL-052	20 Hz to 500 kHz
E4980AL-102	20 Hz to 1 MHz

Note

Option xxx is described as E4980A-xxx in the order information

Table 30. Installable options

Options	E4980A	E4980AL
Power and DC bias enhancement (001)	Installable	Not installable
DCR measurement (200)	Installable ¹	Not installable ²
Handler interface (201)	Installable	Installable
Scanner interface (301)	Installable	Installable

1. Mandatory option

2. DCR measurement function is equipped by default.

Interface options

Option 201 (Handler interface)

Adds handler interface.

Option 301 (Scanner interface)

Adds scanner interface.

Option 710 (No interface)

An option with no interface.

Up to 2 interface options can be installed in the interface connector on the rear panel.

When no interface is installed, two of the option 710 are installed. When one interface is installed, the option number of its interface and one option 710 are installed.

Other options

Option 001 (Power and DC Bias enhancement)

Increases test signal voltage and adds the variable DC bias voltage.

Option 007 (Standard model)

Upgrades the entry model to the standard (only available in E4980AU).

Note

Option 007 can be installed only in the E4980A with option 005.

Option 200 (DCR measurement)

Adds DCR measurement

Note

E4980A-200/001 and E4980AL-032/052/102 supports DCR measurement function.

Power and DC bias enhancement specification

Increases test signal voltage and adds the variable DC bias voltage function. The Vdc-Idc measurement function is available when the option 001 is installed.

Measurement parameters

The following parameters can be used.

- Lp-Rdc
- Ls-Rdc
- Vdc-Idc

where

Rdc Direct-current resistance (DCR)

Vdc Direct-current voltage

Idc Direct-current electricity

Test signal

Signal level

Table 31. Test signal voltage

Range		0 Vrms to 20 Vrms (test frequency \leq 1 MHz) 0 Vrms to 15 Vrms (test frequency $>$ 1 MHz)
Resolution		100 μ Vrms (0 Vrms \leq $- \leq$ 0.2 Vrms) 200 μ Vrms (0.2 Vrms $< - \leq$ 0.5 Vrms) 500 μ Vrms (0.5 Vrms $< - \leq$ 1 Vrms) 1 mVrms (1 Vrms $< - \leq$ 2 Vrms) 2 mVrms (2 Vrms $< - \leq$ 5 Vrms) 5 mVrms (5 Vrms $< - \leq$ 10 Vrms) 10 mVrms (10 Vrms $< - \leq$ 20 Vrms)
Setup accuracy	Normal	\pm (10% + 1 mVrms) (test signal voltage \leq 2 Vrms) (test frequency \leq 1 MHz: spec., test frequency $>$ 1 MHz: typ.)
		\pm (10% + 10 mVrms) (Test frequency \leq 300 kHz, test signal voltage $>$ 2 Vrms) (spec.)
		\pm (15% + 20 mVrms) (test frequency $>$ 300 kHz, test signal voltage $>$ 2 Vrms) (test frequency \leq 1 MHz: spec., test frequency $>$ 1 MHz: typ.)
	Constant ¹	\pm (6% + 1 mVrms) (test signal voltage \leq 2 Vrms) (test frequency \leq 1 MHz: spec., test frequency $>$ 1 MHz: typ.)
		\pm (6% + 10 mVrms) (test frequency \leq 300 kHz, test signal voltage $>$ 2 Vrms) (spec.)
		\pm (12% + 20 mVrms) (test frequency $>$ 300 kHz, test signal voltage $>$ 2 Vrms) (test frequency \leq 1 MHz: spec., test frequency $>$ 1 MHz: typ.)

1. When auto level control function is on.

Table 32. Test signal current

Range		0 Arms - 100 mArms
Resolution		1 μ Arms (0 Arms \leq - \leq 2 mArms) 2 μ Arms (2 mArms < - \leq 5 mArms) 5 μ Arms (5 mArms < - \leq 10 mArms) 10 μ Arms (10 mArms < - \leq 20 mArms) 20 μ Arms (20 mArms < - \leq 50 mArms) 50 μ Arms (50 mArms < - \leq 100 mArms)
Setup accuracy	Normal	\pm (10% + 10 μ Arms) (test signal voltage \leq 20 mArms) (test frequency \leq 1 MHz: spec., test frequency > 1 MHz: typ.)
		\pm (10% + 100 μ Arms) (test frequency \leq 300 kHz, test signal current > 20 mArms) (spec.)
		\pm (15% + 200 μ Arms) (test frequency > 300 kHz, test signal voltage > 20 mArms) (test frequency \leq 1 MHz: spec., test frequency > 1 MHz: typ.)
	Constant ¹	\pm (6% + 10 μ Arms) (test signal voltage \leq 20 mArms) (test frequency \leq 1 MHz: spec., test frequency > 1 MHz: typ.)
		\pm (6% + 100 μ Arms) (test frequency \leq 300 kHz, test signal voltage > 20 mArms) (spec.)
		\pm (12% + 200 μ Arms) (test frequency > 300 kHz, test signal voltage > 20 mArms) (test frequency \leq 1 MHz: spec., test frequency > 1 MHz: typ.)

Test signal level monitor function

- Test signal voltage and test signal current can be monitored.
- Level monitor accuracy:

Table 33. Test signal voltage monitor accuracy (Vac)

Test signal voltage ²	Test frequency	Specification
5 mVrms to 2 Vrms	\leq 1 MHz	\pm (3% of reading value + 0.5 mVrms)
	> 1MHz	\pm (6% of reading value + 1 mVrms)
> 2 Vrms	\leq 300 kHz	\pm (3% of reading value + 5 mVrms)
	> 300 kHz	\pm (6% of reading value + 10 mVrms) ³

1. When auto level control function is on.
2. This is not an output value but a displayed test signal level
3. Typ. when test frequency is > 1 MHz with test signal voltage > 10 Vrms.

Table 34. Test signal current monitor accuracy (Iac)

Test signal current ²	Test frequency	Specification
50 μ Arms to 20 mArms	≤ 1 MHz	\pm (3% of reading value + 5 μ Arms)
	> 1 MHz	\pm (6% of reading value + 10 μ Arms)
> 20 mArms	≤ 300 kHz	\pm (3% of reading value + 50 μ Arms)
	> 300 kHz	\pm (6% of reading value + 100 μ Arms)

DC bias signal**Table 35. Test signal voltage**

Range		-40 V to +40 V
Resolution		Setup resolution: 100 μ V, effective resolution: 330 μ V \pm (0 V $\leq - \leq 5$ V) 1 mV \pm (5 V $< - \leq 10$ V) 2 mV \pm (10 V $< - \leq 20$ V) 5 mV \pm (20 V $< - \leq 40$ V)
Accuracy	test signal voltage ≤ 2 Vrms	0.1% + 2 mV (23°C $\pm 5^\circ$ C) (0.1% + 2 mV) $\times 4$ (0 to 18°C or 28 to 55°C)
	test signal voltage > 2 Vrms	0.1 % + 4 mV (23°C $\pm 5^\circ$ C) (0.1% + 4 mV) $\times 4$ (0 to 18°C or 28 to 55°C)

Table 36. Test signal current

Range		-100 mA - 100 mA
Resolution		Setup resolution: 1 μ A, effective resolution: 3.3 μ A \pm (0 A $\leq - \leq 50$ mA) 10 μ A \pm (50 mA $< - \leq 100$ mA)

DC bias voltage level monitor Vdc

(0.5% of reading value + 60 mV) \times Kt

When using Vdc-I_{dc} measurement: (spec.)

When using level monitor: (typ.)

Kt Temperature coefficient

2. This is not an output value but a displayed test signal level

DC bias current level monitor I_{dc}

(A [%] of the measurement value + B [A]) × K_t

When using V_{dc}-I_{dc} measurement: (spec.)

When using level monitor: (typ.)

A [%] When the measurement time mode is SHORT: 2%
When the measurement time mode is MED or LONG: 1%

B [A] given below

K_t Temperature coefficient

When the measurement mode is SHORT, double the following value.

Table 37. Test signal voltage ≤ 0.2 V_{rms} (measurement time mode = MED, LONG)

DC bias current range	Impedance range [Ω]				
	< 100	100	300, 1 k	3 k, 10 k	30k, 100 k
20 μA	150 μA	30 μA	3 μA	300 nA	45 nA
200 μA	150 μA	30 μA	3 μA	300 nA	300 nA
2 mA	150 μA	30 μA	3 μA	3 μA	3 μA
20 mA	150 μA	30 μA	30 μA	30 μA	30 μA
100 mA	150 μA	150 μA	150 μA	150 μA	150 μA

Table 38. 0.2 V_{rms} < test signal voltage ≤ 2 V_{rms} (measurement time mode = MED, LONG)

DC bias current range	Impedance range [Ω]				
	< 100	100, 300	1k, 3 k	10k, 30 k	100 k
20 μA	150 μA	30 μA	3 μA	300 nA	45 nA
200 μA	150 μA	30 μA	3 μA	300 nA	300 nA
2 mA	150 μA	30 μA	3 μA	3 μA	3 μA
20 mA	150 μA	30 μA	30 μA	30 μA	30 μA
100 mA	150 μA	150 μA	150 μA	150 μA	150 μA

Table 39. Test signal voltage > 2 Vrms (measurement time mode = MED, LONG)

DC bias current range	Impedance range [Ω]			
	≤ 300	1 k, 3 k	10k, 30 k	100 k
20 μ A	150 μ A	30 μ A	3 μ A	300 nA
200 μ A	150 μ A	30 μ A	3 μ A	300 nA
2 mA	150 μ A	30 μ A	3 μ A	3 μ A
20 mA	150 μ A	30 μ A	30 μ A	30 μ A
100 mA	150 μ A	150 μ A	150 μ A	150 μ A

Table 40. Input impedance (nominal)

Input impedance	Conditions
0 Ω	Other than conditions below.
20 Ω	Test signal voltage ≤ 0.2 Vrms, Impedance range ≥ 3 k Ω , DC bias current range ≤ 200 μ A
	Test signal voltage ≤ 2 Vrms, Impedance range ≥ 10 k Ω , DC bias current range ≤ 200 μ A
	Test signal voltage > 2 Vrms, Impedance range = 100 k Ω , DC bias current range ≤ 200 μ A

DC source signal

Table 41. Test signal voltage

Range	-10 V to 10 V
Resolution	1 mV
Accuracy	0.1% + 3 mV (23°C \pm 5°C) (0.1% + 3 mV) x 4 (0 to 18°C or 28 to 55°C)

Table 42. Test signal current

Range	-45 mA to 45 mA (nominal)
-------	---------------------------

Output impedance: 100 Ω (nominal)

DCR measurement specification

DC resistance (Rdc) measurement function is available when either E4980A-001/200 or E4980AL-032/052/102 is installed.

DC resistance (Rdc) accuracy

Absolute measurement accuracy Aa

Absolute measurement accuracy Aa is given as

Equation 15. $Aa = Ae + Acal$

Aa Absolute accuracy (% of reading value)

Ae Relative accuracy (% of reading value)

Acal Calibration accuracy

Relative measurement accuracy Ae

Relative measurement accuracy Ae is given as

Equation 16. $Ae = [Ab + (Rs / |Rm| + Go \times |Rm|) \times 100] \times Kt$

Rm Measurement value

Ab Basic accuracy

Rs Short offset [Ω]

Go Open offset [S]

Kt Temperature coefficient

Calibration accuracy Acal

Calibration accuracy Acal is 0.03%.

Basic accuracy Ab

Table 43. Basic accuracy Ab.

Measurement time mode	Test signal voltage	
	≤ 2 Vrms	> 2 Vrms
SHORT	1.00%	2.00%
MED	0.30%	0.60%

Open offset Go

Table 44. Open offset Go.

Measurement time mode	Test signal voltage	
	$\leq 2 \text{ Vrms}$	$> 2 \text{ Vrms}$
SHORT	50 nS	500 nS
MED	10 nS	100 nS

Short offset Rs

Table 45. Short offset Rs.

Measurement time mode	Test signal voltage	
	$\leq 2 \text{ Vrms}$	$> 2 \text{ Vrms}$
SHORT	25 m Ω	250 m Ω
MED	5 m Ω	50 m Ω

Effect of cable length (Short offset)

Table 46. Values added to Rs when the cable is extended.

Cable length		
1 m	2 m	4 m
0.25 m Ω	0.5 m Ω	1 m Ω

Temperature coefficient Kt

Table 47. Temperature coefficient Kt.

Temperature [$^{\circ}\text{C}$]	Kt
$0 \leq - < 18$	4
$18 \leq - \leq 28$	1
$28 < - \leq 55$	4

General Specifications

Table 48. Power source

Rated voltage	100 – 240 VAC
Voltage range	90 – 264 VAC
Rated frequency	50 / 60 Hz
Frequency range	47 – 63 Hz
Power consumption	Max. 150 VA

Table 49. Operating environment

Temperature	0 – 55°C
Humidity ($\leq 40^\circ\text{C}$, no condensation)	15% – 85% RH
Altitude	0 m – 2000 m

Table 50. Storage environment

Temperature	-20 – 70°C
Humidity ($\leq 60^\circ\text{C}$, no condensation)	0% – 90% RH
Altitude	0 m – 4572 m

Outer dimensions: 375 (width) x 105 (height) x 390 (depth) mm (nominal)

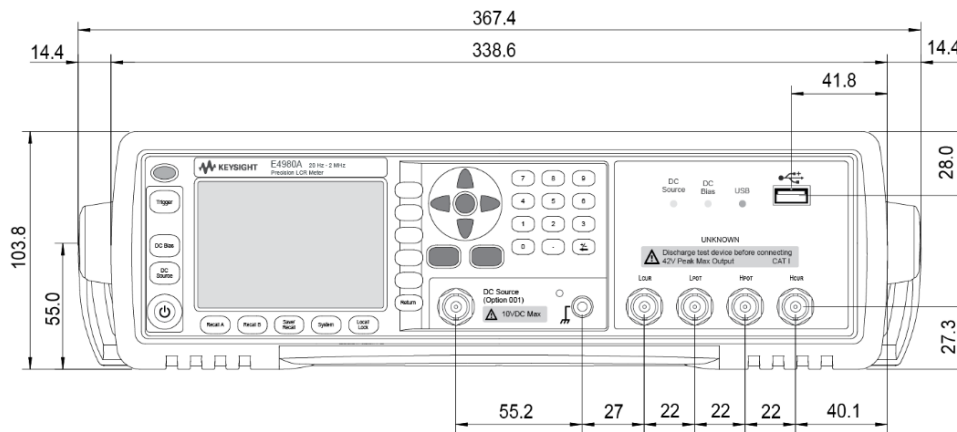

Figure 2. Dimensions (front view, with handle and bumper, in millimeters, nominal)

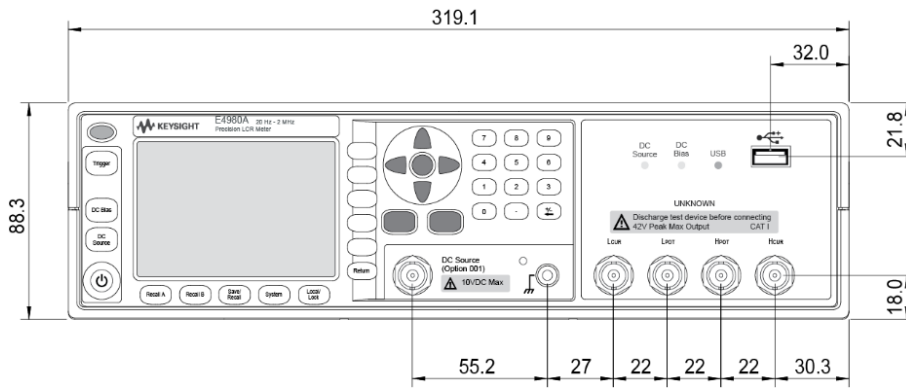

Figure 3. Dimensions (front view, without handle and bumper, in millimeters, nominal)

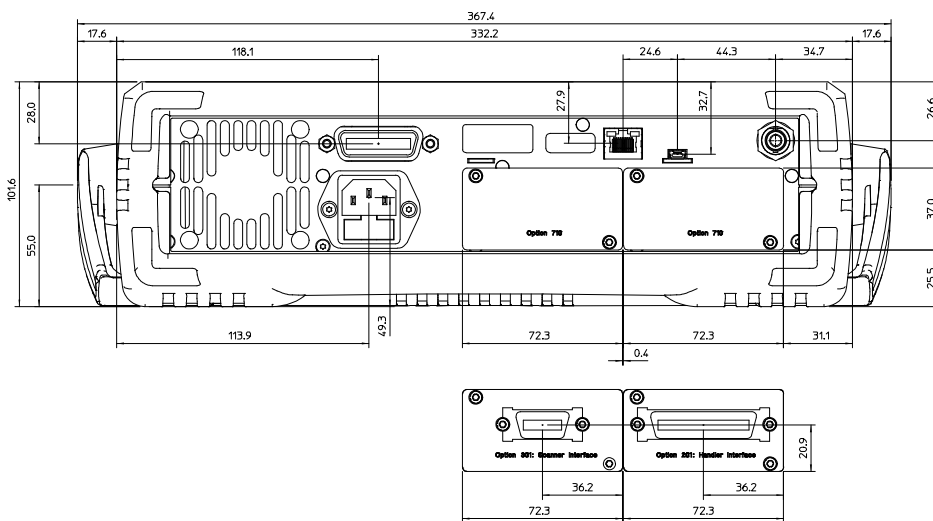

Figure 4. Dimensions (rear view, with handle and bumper, in millimeters, nominal)

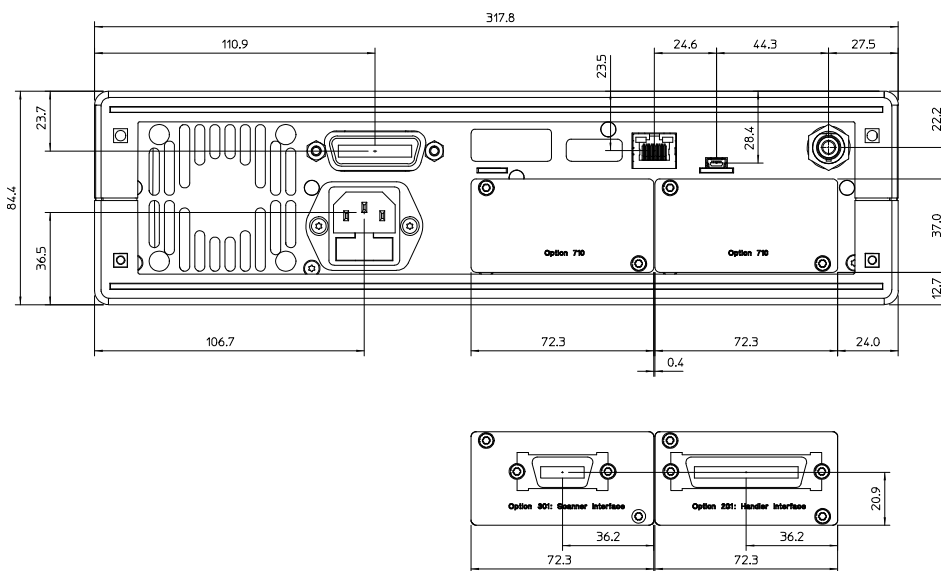

Figure 5. Dimensions (rear view, with handle and bumper, in millimeters, nominal)

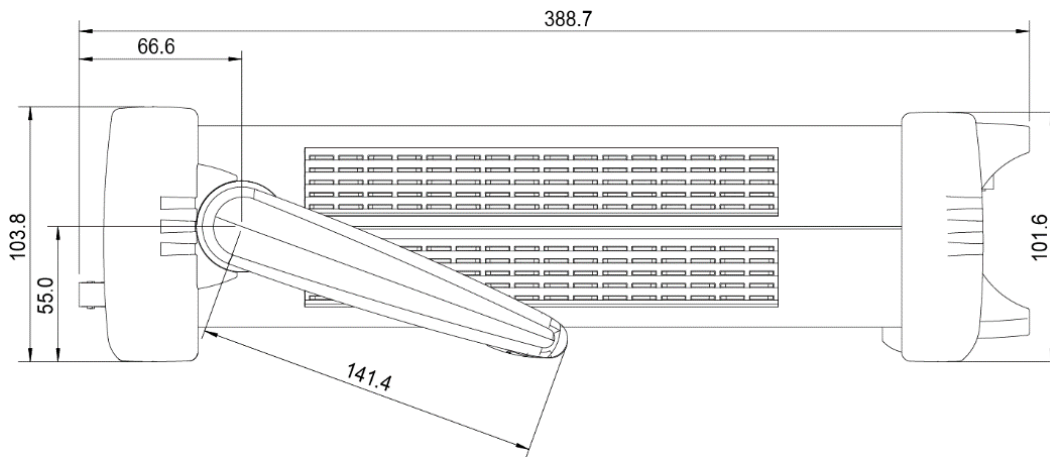

Figure 6. Dimensions (side view, with handle and bumper, in millimeters, nominal)

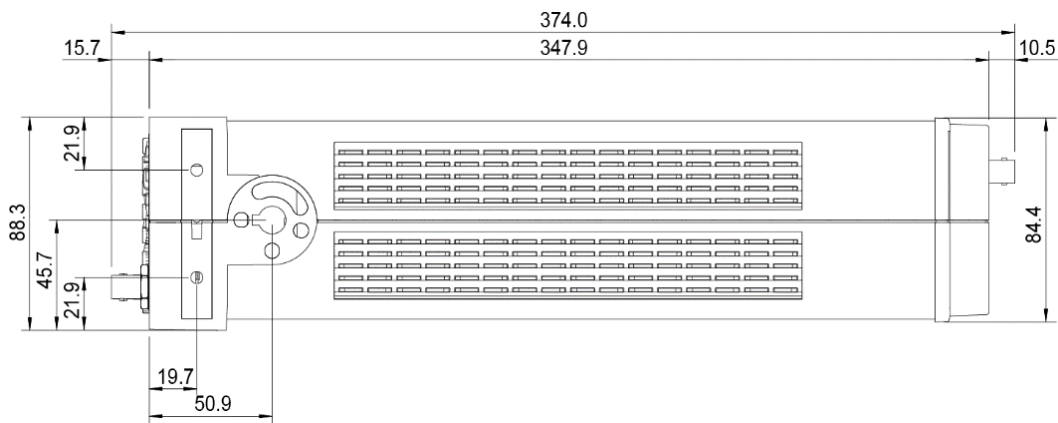

Figure 7. Dimensions (side view, without handle and bumper, in millimeters, nominal)

Weight: 5.3 kg (nominal)





Display: LCD, 320 × 240 (pixels), RGB color

Note

Effective pixels are more than 99.99%. There may be 0.01% (approx. 7 pixels) or smaller missing pixels or constantly lit pixels, but this is not a malfunction.

The following items can be displayed:

- Measurement value
- Measurement conditions
- Limit value and judgment result of comparator
- List sweep table
- Self-test message

EMC ¹	
Complies with the essential requirements of the European EMC Directive as well as current editions of the following standards (dates and editions are cited in the Declaration of Conformity).	
	<p>The CE mark is a registered trademark of the European Community (if accompanied by a year, it is the year when the design was proven). This product complies with all relevant directives.</p> <ul style="list-style-type: none"> • IEC 61326-1 • CISPR 11 Group 1, Class A
	UK conformity mark is a UK government owned mark. When affixed to the product is declaring all applicable Directives and Regulations have been met in full.
CAN ICES/NMB-001(A)	This ISM device complies with Canadian ICES-001. Cet appareil ISM est conforme a la norme NMB du Canada.
	<p>The RCM mark is a registered trademark of the Australian Communications and Media Authority.</p> <ul style="list-style-type: none"> • AS/NZS CISPR 11
	<p>South Korean Certification (KC) mark; includes the marking's identifier code: R-R-Kst-xxxxxxx</p> <p>South Korean Class A EMC declaration: Information to the user: This equipment has been conformity assessed for use in business environments. In a residential environment this equipment may cause radio interference. ※ This EMC statement applies to the equipment only for use in business environment.</p> <div style="border: 1px solid black; padding: 5px; margin-top: 10px;"> <p style="text-align: center; background-color: #e1eef6;">사 용 자 안 내 문</p> <p style="text-align: center;">이 기기는 업무용 환경에서 사용할 목적으로 적합성평가를 받은 기기로서 가정용 환경에서 사용하는 경우 전파간섭의 우려가 있습니다.</p> </div> <p>※ 사용자 안내문은 “업무용 방송통신기자재”에만 적용한다.</p>

Safety ¹	
Complies with the essential requirements of the European Low Voltage Directive as well as current editions of the following standards (dates and editions are cited in the Declaration of Conformity). This product is designed for use in INSTALLATION CATEGORY II and POLLUTION DEGREE 2 and MEASUREMENT CATEGORY NONE per IEC standards. This product is intended for indoor use.	
	<ul style="list-style-type: none"> • IEC/EN 61010-1
	<p>The CSA mark is a registered trademark of the CSA International.</p> <ul style="list-style-type: none"> • Canada: CSA C22.2 No. 610610-1 • USA: UL std no. 61010-1

1. To find a current Declaration of Conformity for a specific Keysight product, go to: <http://www.keysight.com/go/conformity>.

Environment

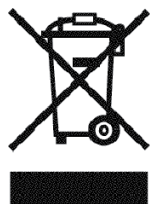

This product complies with the WEEE Directive (2002/96/EC) marking requirements. The affixed label indicates that you must not discard this electrical/electronic product in domestic household waste.

Product Category: With reference to the equipment types in the WEEE Directive Annex I, this product is classed as a “Monitoring and Control instrumentation” product.

Supplemental Information

Settling time

Table 51. Test frequency setting time

Test frequency setting time	Test frequency (Fm)
5 ms	$F_m \geq 1 \text{ kHz}$
12 ms	$1 \text{ kHz} > F_m \geq 250 \text{ Hz}$
22 ms	$250 \text{ Hz} > F_m \geq 60 \text{ Hz}$
42 ms	$60 \text{ Hz} > F_m$

Table 52. Test signal voltage setting time

Test signal voltage setting time	Test frequency (Fm)
11 ms	$F_m \geq 1 \text{ kHz}$
18 ms	$1 \text{ kHz} > F_m \geq 250 \text{ Hz}$
26 ms	$250 \text{ Hz} > F_m \geq 60 \text{ Hz}$
48 ms	$60 \text{ Hz} > F_m$

Switching of the impedance range is as follows: $\leq 5 \text{ ms/ range switching}$

Measurement circuit protection

The maximum discharge withstand voltage, where the internal circuit remains protected if a charged capacitor is connected to the UNKNOWN terminal, is given below.

Table 53. Maximum discharge withstand voltage

Maximum discharge withstand voltage	Range of capacitance value C of DUT
1000 V	$C < 2 \mu\text{F}$
$\sqrt{2/CV}$	$2 \mu\text{F} \leq C$

Note

Discharge capacitors before connecting them to the UNKNOWN terminal or a test fixture to avoid damages to the instrument.

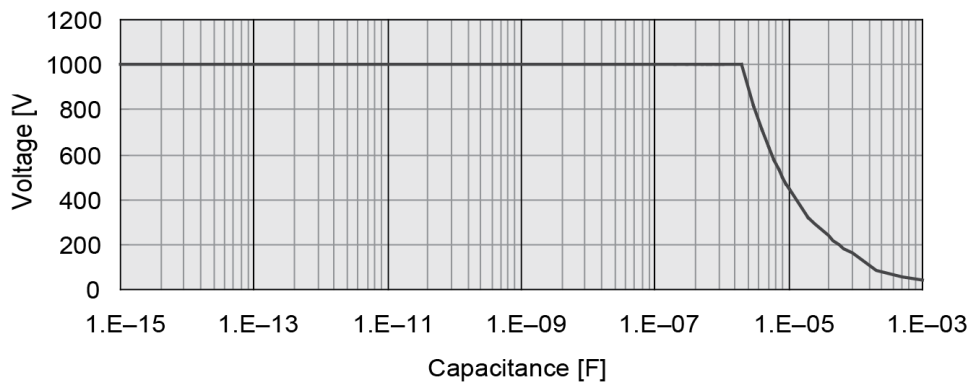

Figure 8. Maximum discharge withstand voltage

Measurement time

Definition

This is the time between the trigger and the end of measurement (EOM) output on the handler interface.

Conditions

Tables 54 and 55 show the measurement time when the following conditions are satisfied:

- Normal impedance measurement other than Ls-Rdc, Lp-Rdc, Vdc-Idc
- Impedance range mode: hold range mode
- DC bias voltage level monitor: OFF
- DC bias current level monitor: OFF
- Trigger delay: 0 s
- Step delay: 0 s
- Calibration data: OFF
- Display mode: blank

Table 54. E4980A measurement time [ms] (DC bias: OFF)

Measurement time mode		Test frequency						
		20 Hz	100 Hz	1 kHz	10 kHz	100 kHz	1 MHz	2 MHz
1	LONG	480	300	240	230	220	220	220
2	MED	380	180	110	92	89	88	88
3	SHORT	330	100	20	7.7	5.7	5.6	5.6

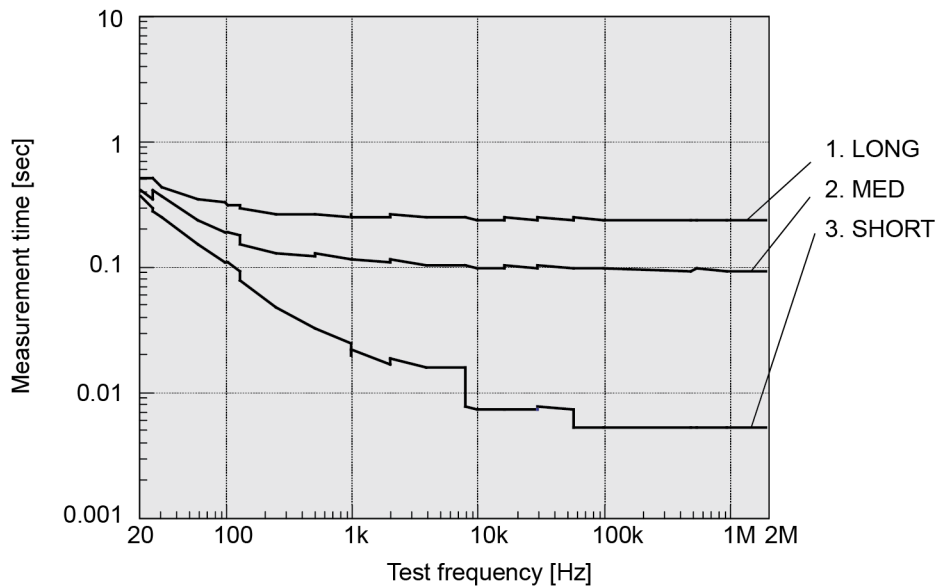

Figure 9. Measurement time (E4980A, DC bias: OFF)

Table 55. E4980AL measurement time [ms] (DC bias: OFF)

Measurement time mode		Test frequency					
		20 Hz	100 Hz	1 kHz	10 kHz	100 kHz	1 MHz
1	LONG	729	423	363	353	343	343
2	MED	650	250	140	122	119	118
3	SHORT	579	149	26	14	12	12

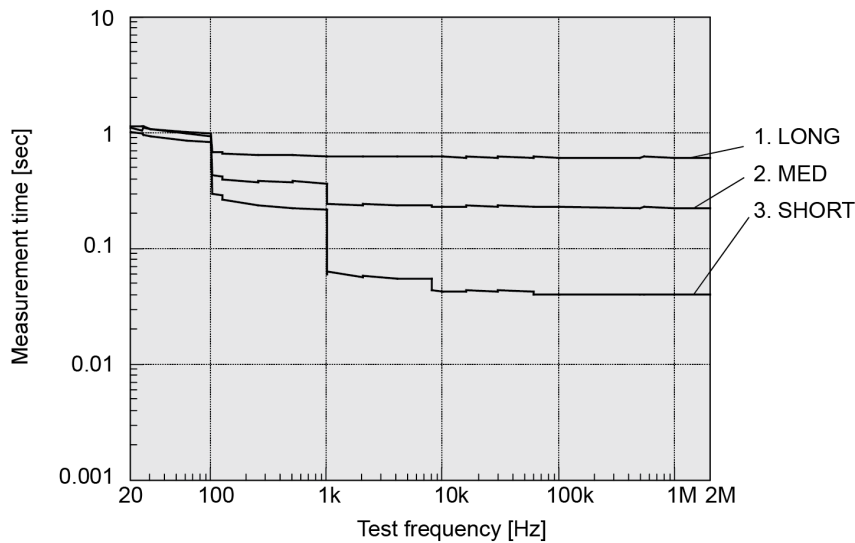

Figure 10. Measurement time (E4980AL)

When DC bias is ON, the following time is added:

Table 56. Additional time when DC bias is ON [ms]

Test frequency						
20 Hz	100 Hz	1 kHz	10 kHz	100 kHz	1 MHz	2 MHz
30	30	10	13	2	0.5	0.5

When the number of averaging increases, the measurement time is given as

Equation 17. $MeasTime + (Ave - 1) \times AveTime$

MeasTime Measurement time calculated based on Table 54, 55 and 56
 Ave Number of averaging
 AveTime Refer to Table 57

Table 57. Additional time per averaging [ms]

Measurement time mode	Test frequency						
	20 Hz	100 Hz	1 kHz	10 kHz	100 kHz	1 MHz	2 MHz
SHORT	51	11	2.4	2.3	2.3	2.2	2.2
MED	110	81	88	87	85	84	84
LONG	210	210	220	220	220	210	210

Table 58. Measurement time when Vdc-Idc is selected [ms]

Measurement time mode	Test frequency						
	20 Hz	100 Hz	1 kHz	10 kHz	100 kHz	1 MHz	2 MHz
SHORT	210	46	14	14	14	14	14
MED	210	170	170	170	170	170	170
LONG	410	410	410	410	410	410	410

Add the same measurement time per 1 additional average.

Additional Measurement time when the Vdc and Idc monitor function is ON. Add SHORT mode of Table 58. When using only Vdc or Idc, add a half of SHORT mode of Table 58.

Table 59. Measurement time when Ls-Rdc or Lp-Rdc is selected [ms]

Measurement time mode	Test frequency						
	20 Hz	100 Hz	1 kHz	10 kHz	100 kHz	1 MHz	2 MHz
SHORT	910	230	43	24	22	22	22
MED	1100	450	300	280	270	270	270
LONG	1400	820	700	670	660	650	650

Add the three times of Table 57 Additional Time per 1 additional average number.

Display time

Except for the case of the DISPLAY BLANK page, the time required to update the display on each page (display time) is as follows. When a screen is changed, drawing time and switching time are added. The measurement display is updated about every 100 ms.

Table 60. Display time

Item	When Vdc, Idc monitor is OFF	When Vdc, Idc monitor is ON
MEAS DISPLAY page drawing time	10 ms	13 ms
MEAS DISPLAY page (large) drawing time	10 ms	13 ms
BIN No. DISPLAY page drawing time	10 ms	13 ms
BIN COUNT DISPLAY page drawing time	10 ms	13 ms
LIST SWEEP DISPLAY page drawing time	40 ms	—
Measurement display switching time	35 ms	—

Measurement data transfer time

This table shows the measurement data transfer time under the following conditions. The measurement data transfer time varies depending on measurement conditions and computers.

Table 61. Measurement transfer time under the following conditions

Host computer:	HP Z420 Workstation, Xeon CPU ES-1620 0 @3.60 GHz
Display:	OFF
Impedance range mode:	AUTO (The overload has not been generated.)
OPEN/SHORT/LOAD compensation:	OFF
Test signal voltage monitor:	OFF

Table 62. Measurement data transfer time [ms]

Interface	Data transfer format	Using: FETC? command (one point measurement)		Using data buffer memory (list sweep measurement)			
		Comparator ON	Comparator OFF	10 points	51 points	128 points	201 points
GPIB	ASCII	2	2	4	13	28	43
	ASCII Long	2	2	5	15	34	53
	Binary	2	2	4	10	21	36
USB	ASCII	2	2	3	8	16	23
	ASCII Long	2	2	4	9	19	28
	Binary	2	2	3	5	9	13
LAN	ASCII	3	4	5	12	24	36
	ASCII Long	3	3	5	13	29	44
	Binary	3	3	5	9	18	26

DC bias test signal current (1.5 V/2.0 V): Output current: Max. 20 mA

Option 001 (Power and DC Bias enhance):

DC bias voltage: DC bias voltage applied to DUT is given as:

Equation 18. $V_{dut} = V_b - 100 \times I_b$

V_{dut} [V] DC bias voltage
 V_b [V] DC bias setting voltage
 I_b [A] DC bias current

DC bias current: DC bias current applied to DUT is given as:

Equation 19. $I_{dut} = V_b / (100 + R_{dc})$

I_{dut} [A] DC bias current
 V_b [V] DC bias setting voltage
 R_{dc} [Ω] DUT's DC resistance

Maximum DC bias current

Table 63. Maximum DC bias current when the normal measurement can be performed.

Impedance range [Ω]	Bias current isolation		
	ON	OFF	
		Test signal voltage $\leq 2 V_{rms}$	Test signal voltage $> 2 V_{rms}$
0.1	Auto range mode: 100 mA Hold range mode: its values for the range.	20 mA	100 mA
1		20 mA	100 mA
10		20 mA	100 mA
100		20 mA	100 mA
300		2 mA	100 mA
1 k		2 mA	20 mA
3 k		200 μ A	20 mA
10 k		200 μ A	2 mA
30 k		20 μ A	2 mA
100 k		20 μ A	200 μ A

When DC bias is applied to the DUT, add the following value to the absolute accuracy A_b .

Table 64. Only when Fm < 10 kHz and |Vdc| > 5 V

SHORT	MED, LONG
$0.05\% \times (100 \text{ mV/Vs}) \times (1 + \sqrt{(100/Fm)})$	$0.01\% \times (100 \text{ mV/Vs}) \times (1 + \sqrt{(100/Fm)})$

Fm [Hz] Test frequency
Vs [V] Test signal voltage

Relative measurement accuracy with bias current isolation

When DC bias Isolation is set to ON, add the following value to the open offset Yo.

Equation 20. $Yo_DCI1 \times (1 + 1/(Vs)) \times (1 + \sqrt{(500/Fm)}) + Yo_DCI2$

Zm [Ω] Impedance of DUT
Fm [Hz] Test frequency
Vs [V] Test signal voltage
Yo_DCI1,2 [S] Calculate this by using Table 65 and 66
Idc [A] DC bias isolation current

Table 65. Yo_DCI1 value

DC bias current range	Measurement time mode	
	SHORT	MED, LONG
20 μA	0 S	0 S
200 μA	0.25 nS	0.05 nS
2 mA	2.5 nS	0.5 nS
20 mA	25 nS	5 nS
100 mA	250 nS	50 nS

Table 66. Yo_DCI2 value

DC bias current range	Measurement time mode			
	≤ 100 Ω	300 Ω, 1 k Ω	3 k Ω, 10 k Ω	30 k Ω, 100 k Ω
20 μA	0 S	0 S	0 S	0 S
200 μA	0 S	0 S	0 S	0 S
2 mA	0 S	0 S	0 S	3 nS
20 mA	0 S	0 S	30 nS	30 nS
100 mA	0 S	300 nS	300 nS	300 nS

DC bias settling time

When DC bias is set to ON, add the following value to the settling time:

Table 67. DC bias settling time

	Bias	Settling time
1	Standard	Capacitance of DUT × 100 × loge (2/1.8 m) + 3 m
2	Option 001	Capacitance of DUT × 100 × loge (40/1.8 m) + 3 m

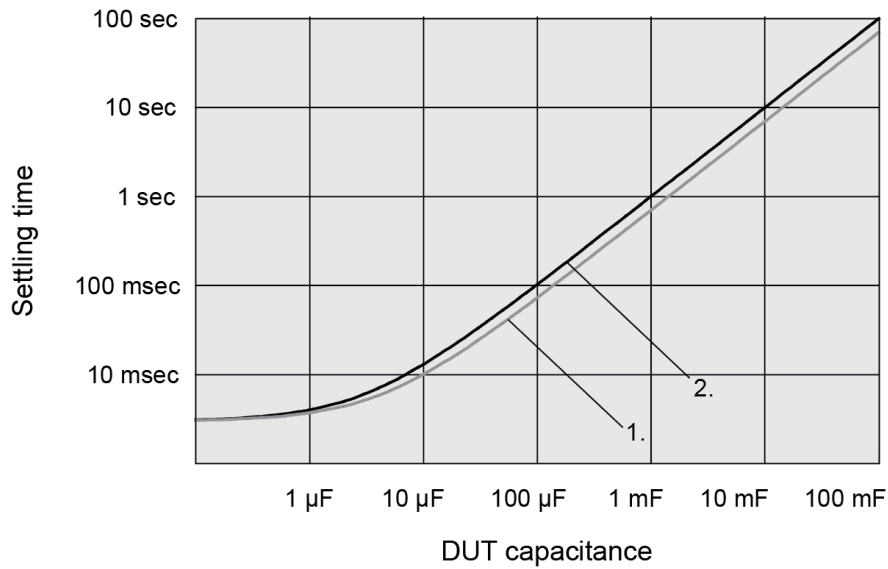

Figure 11. DC bias settling time