

Product Datasheet - Technical Specifications



More information in our Web-Shop at ► www.meilhaus.com and in our download section.

Your contact

**Technical and commercial sales, price information,
quotations, demo/test equipment, consulting:**

Tel.: **+49 - 81 41 - 52 71-0**

FAX: **+49 - 81 41 - 52 71-129**

E-Mail: sales@meilhaus.com

Downloads:

www.meilhaus.com/en/infos/download.htm

Meilhaus Electronic GmbH | Tel. **+49 - 81 41 - 52 71-0**
Am Sonnenlicht 2 | Fax **+49 - 81 41 - 52 71-129**
82239 Alling/Germany | E-Mail sales@meilhaus.com

Mentioned company and product names may be registered trademarks of the respective companies. Prices in Euro plus VAT. Errors and omissions excepted.
© Meilhaus Electronic.

www.meilhaus.de



Transmitter w/ alarm



841T Transmitters

Frequency, Pulse Counter Input

Models

841T-0500: Frequency input transmitter
841T-1500: Transmitter with limit alarm

Input Ranges

Sensor types: TTL, dry contact, open collector NPN/PNP, NAMUR, magnetic pickups, proximity

Frequency: 0 to 100Hz, 0 to 1KHz, 0 to 50KHz
Pulse: 0 to 65535 pulses

Output Ranges

0 to 1mA, 0 to 20mA, 4 to 20mA DC
0 to 5V, 0 to 10V DC

Limit Alarm

SPDT electro-mechanical relay (-1500 unit only)

Power Requirement

10 to 36V DC

Approvals

UL, cUL listed.

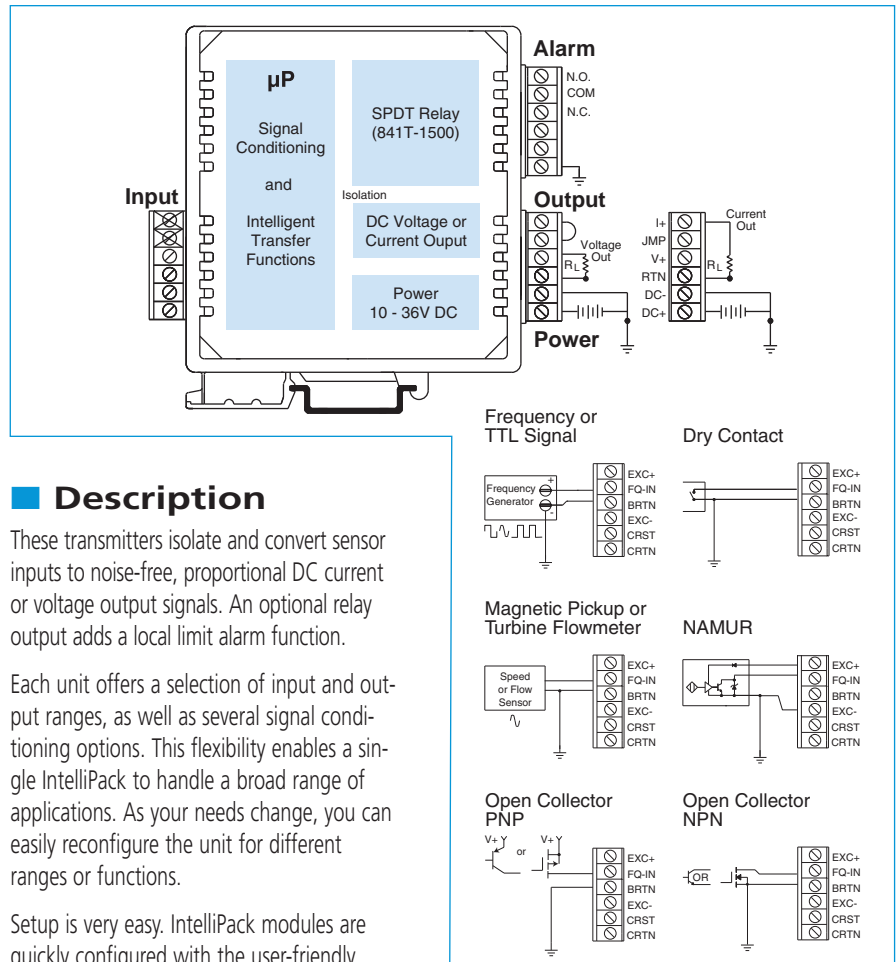

Description

These transmitters isolate and convert sensor inputs to noise-free, proportional DC current or voltage output signals. An optional relay output adds a local limit alarm function.

Each unit offers a selection of input and output ranges, as well as several signal conditioning options. This flexibility enables a single IntelliPack to handle a broad range of applications. As your needs change, you can easily reconfigure the unit for different ranges or functions.

Setup is very easy. IntelliPack modules are quickly configured with the user-friendly Windows software program. Field adjustments are simple with the module's front-panel push-buttons and status LEDs. Once configured, IntelliPacks operate independent of any host computer.

Special Features

- High-resolution Sigma-Delta A/D converter delivers high accuracy with low noise.
- Advanced microcontroller provides intelligent signal processing power for linearization, averaging, and square root computations.
- Windows XP/Vista/7 software configuration speeds setup and replacement.
- Multi-purpose inputs and outputs reduce spare stock requirements.
- Relay output option provides local limit alarm capability.

Performance

General Input

Resolution

Input Range	Resolution
0 to 100Hz	0.01Hz
0 to 1000Hz	0.1Hz
0 to 50,000Hz	1Hz
0 to 65,535 pulses	1 pulse

Noise Rejection

Common Mode: Better than 80dB @ 60Hz.

Input Response Time (for input step change)
-3dB @ 35KHz.

Input Overvoltage Protection

Bipolar Transient Voltage Suppressors (TVS).

Continued on next page.



■ Performance

■ Frequency Input

Input Types

TTL, dry contact, open collector NPN/PNP, NAMUR, magnetic pickups, proximity sensors.

Frequency Ranges

0 to 100Hz
0 to 1000Hz
0 to 50,000Hz.

Pulse Counter Input Range

0 to 65535 pulses.

Minimum Input Pulse Width

Frequency inputs: 10µs.
Pulse counting inputs: 5mS.

Voltage Ranges

Unipolar: 0 to 100V DC.
Bipolar: ±50mV to ±100V peak.

Zero/Full Scale Adjustment

Zero and span: 100% full range adjustment.
Pulse counting: Up to 65535 spans within range.

Input Threshold/Hysteresis

Bipolar:
Threshold: 0.01V, typical.
Hysteresis: ±25mV or ±83mV.
Unipolar:
Threshold: 1.5V or 5V.
Hysteresis: ±25mV or ±83mV

Input Debounce (Event Counter)

0 to 1000mS (configurable in 5mS increments).

Frequency Excitation Supply

Selectable, +8.2V or +12V @ 15mA.

Input Impedance

35K ohms, typical.

Accuracy

Input Range	Accuracy
0 to 100Hz	±0.04Hz
0 to 1000Hz	±0.4Hz
0 to 50,000Hz	±10Hz
0 to 65,535 pulses	±1 pulse

■ Output (DC V/mA)

D/A Converter

16-bit Σ-Δ.

Current Output

Ranges: 0-1mA, 0-20mA, 4-20mA.
Compliance: 10V minimum (500Ω load).
Accuracy: 0.025% of span.

Voltage Output

Ranges: 0-5V, 0-10V.
Compliance: 10mA maximum with short circuit protection. 1 ohm output impedance.
Accuracy: 0.025% of span.

Accuracy (overall input to output)

0.075% of span.

■ Output (Relay)

Relay

One SPDT electro-mechanical relay.

Relay Ratings (CSA ratings)

25V DC @ 5A.
120/240V AC @ 5A.

Relay Time Delay

Adjustable alarm delay of up to 25 seconds.

Contact Material

Silver-cadmium oxide (AgCdO).

Expected Mechanical Life

20 million operations.

■ Environmental

Ambient Temperature

Operating: -25 to 70°C (-13 to 158°F).
Storage: -40 to 85°C (-40 to 185°F).

Relative Humidity

5 to 95%.

Power Requirements

10 to 36V DC. 100mA @ 24V. 160mA @ 15V.

Isolation (optical)

4-way (input/output/relay/power).
1500V AC for 60 seconds or 250V AC continuous.

Radiated Field Immunity (RFI)

EN61000-4-3, EN50082-1.

Electromagnetic Field Immunity (EMI)

Less than ±0.25% of output span effect under the influence of electromagnetic fields from switching solenoids, commutator motors, and drill motors.

Electrical Fast Transient (EFT)

EN61000-4-4, EN50082-1.

Surge Withstanding Capability (SWC)

EN61000-4-5, EN50082-1.

Electrostatic Discharge (ESD)

EN61000-4-2, EN50082-1.

Radiated Emissions

EN50081-1 for Class B equipment.

Approvals

UL listed (USA, Canada).
UL3121 - general product safety.

■ Configuration

Software Configuration

Units are fully programmable via the Windows XP/Vista/7 IntelliPack Configuration Program. Configuration downloads from PC through EIA232 serial port using Acromag 800C-SIP kit.

Field Configuration

Output, zero/full-scale, relay setpoint and deadband are configurable via push-buttons and a standard calibrator.

LED Indicators

LEDs indicate power, status, calibration, and alarm.

■ Physical

Enclosure

Case: Thermoplastic UL94 V-2 NEMA Type 1 enclosure.

Connectors (Removable Terminal Blocks)

Wire Range: AWG #14-22 (AWG #12 stranded only).

Printed Circuit Boards

Military grade FR-4 epoxy glass circuit board.

Dimensions and Shipping Weight

1.05W x 4.68H x 4.35D in. (26.7 x 118.9 x 110.5 mm)
1 pound (0.45 Kg) packed.

■ Ordering Information

IMPORTANT: All IntelliPacks require initial software configuration (order 800C-SIP). See Note 1 below.

841T-0500

IntelliPack transmitter unit (freq/pulse counter input).

841T-1500

Same as above, plus an SPDT relay output.

800C-SIP

Software Interface Package.

Only one kit is required for all IntelliPack models. See diagram on Page 83 for included parts.

5034-225

USB-to-RS232 adapter. See page 121 for more info.

PSSR-VD24

Power supply (24V DC, 2.1A).
See Power Supplies on Page 199.

TBK-B01

Optional terminal block kit, barrier strip style, 2 pcs. (For use with 841T-0500 model.)

TBK-B02

Optional terminal block kit, barrier strip style, 4 pcs. (For use with 841T-1500 model with alarm.)

TBK-S01

Optional terminal block kit, spring clamp style, 2 pcs. (For use with 841T-0500 model.)

TBK-S02

Optional terminal block kit, spring clamp style, 4 pcs. (For use with 841T-1500 model with alarm.)

NOTE 1: To order factory configuration, call Acromag for a configuration form which must accompany your order. Also, append "-C" to model number (example: 841T-1500-C). 800C-SIP kit is still recommended.

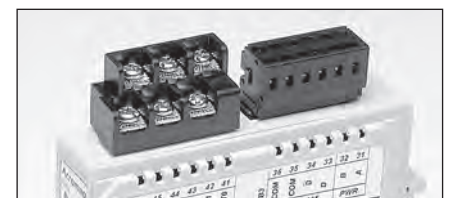

Optional terminal blocks: barrier strip (left) and spring clamp (right). Cage clamp terminal is standard.



Dimensions

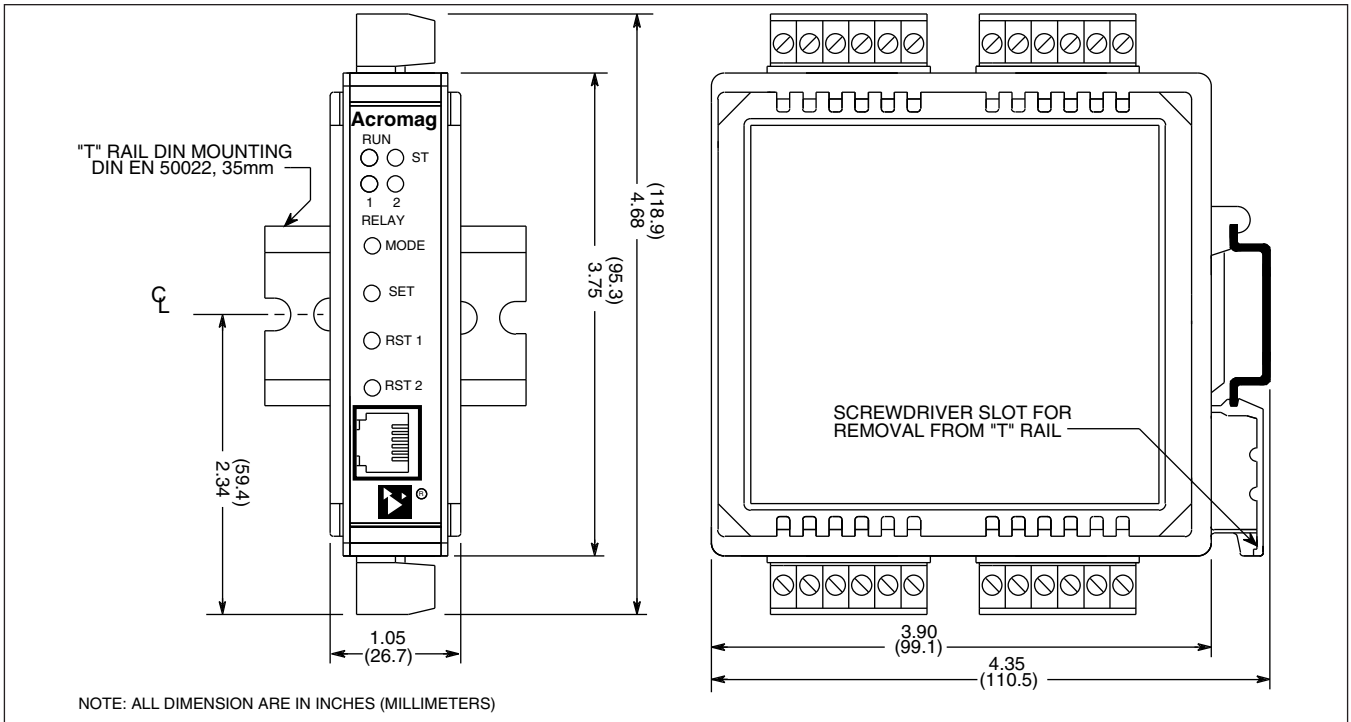



Accessories

Terminal Blocks

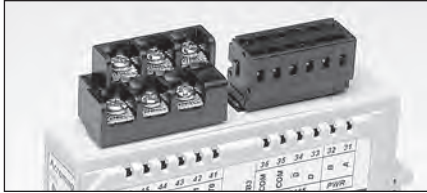

Barrier strip (left) and spring clamp (right).

Ordering Information

See individual I/O modules for compatibility.

Barrier Strip Terminal Blocks

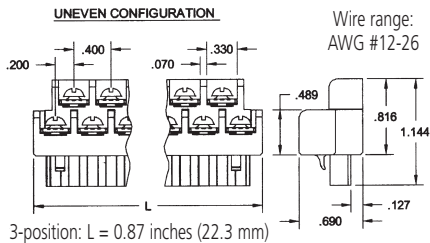
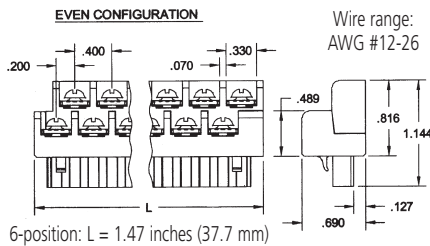

TBK-B01
Terminal block kit,
two 6-position pieces

TBK-B02
Terminal block kit,
four 6-position pieces

TBK-B03
Terminal block kit,
one 3-position and
three 6-position pieces

Spring Clamp Terminal Blocks

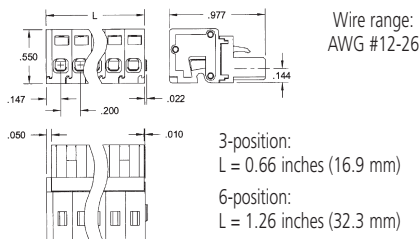

TBK-S01
Terminal block kit,
two 6-position pieces

TBK-S02
Terminal block kit,
four 6-position pieces

TBK-S03
Terminal block kit,
one 3-position and
three 6-position pieces

Mounting Hardware



DIN-Rail Mounting

For your convenience, Acromag offers several mounting accessories to simplify your system installation. Our 19" rack-mount kit provides a clean solution for mounting your I/O modules and a power supply. Or you can buy precut DIN rail strips for mounting on any flat surface.

Ordering Information

20RM-16-DIN
19" rack-mount kit with DIN rail.

DIN RAIL 3.0
DIN RAIL 16.7
DIN rail strip, Type T, 3 inches (75mm) or
16.7 inches (425mm)

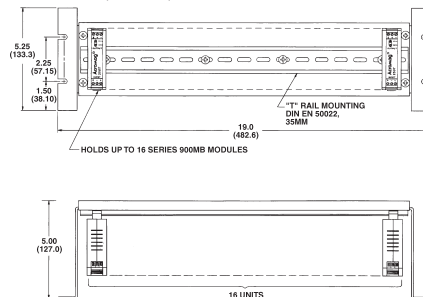

Power Supplies

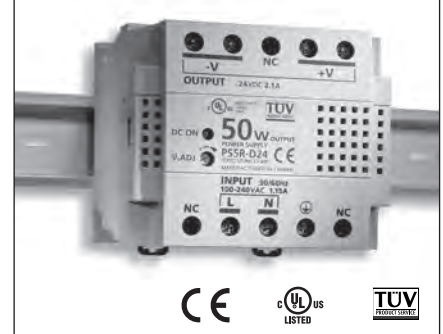

50W Supply

Input Power Requirement
85 to 264V AC or 105 to 370V DC

Output
24V DC, 2.1A (50W)

Ordering Information

PS5R-VD24
Universal 50W power supply

See Power Supplies on Page 199 for other models and more information.

USB / RS232 Adapter



Length: 3.15 in (8.0 cm)
Height: 0.80 in (2.03 cm)
Width: 1.75 in (4.44 cm)
Weight: 1.6 oz (45.36 g)

Ordering Information

5034-225
USB-to-RS232 adapter

AC Current Sensor

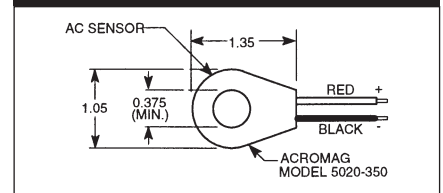

Ordering Information

5020-350
AC current sensor (See page 205)

IntelliPack®: 800 Series

IntelliPack 800 Series Signal Conditioners

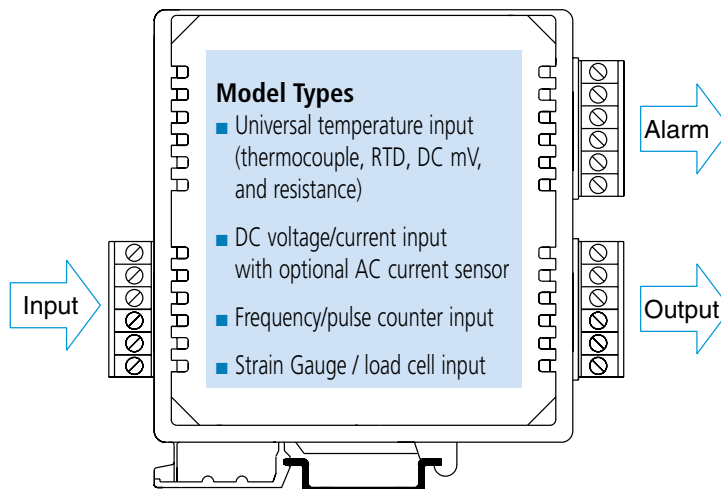

Universal temperature input ◆ DC voltage/current input ◆ Frequency input ◆ Strain gauge input

800T Models

801T: Universal temperature input (thermocouple, RTD, DC mV, and resistance)

811T: DC voltage/current input with optional AC current sensor

841T: Frequency/pulse counter input

851T: Strain gauge / load cell input

IntelliPack transmitters isolate and convert sensor inputs to noise-free, proportional DC current or voltage output signals. An optional relay output adds a local limit alarm function.

Each unit offers a selection of input and output ranges, as well as several signal conditioning options. This flexibility enables a single IntelliPack to handle a broad range of applications. As your needs change, you can easily reconfigure the unit for different ranges or functions.

The internal microprocessor provides several computation functions. A linearizer function lets you linearize/characterize the input signal with custom break points. The averaging function outputs a signal that is proportional to the average of the previous "n" samples, where n is user-defined. IntelliPacks can also generate an output signal that is proportional to the square root of the input signal. Other functions are possible (consult factory).

Setup is very easy. IntelliPack modules are quickly configured with the user-friendly Windows software program. Field adjustments are simple with

the module's front-panel push-buttons and status LEDs. Once configured, IntelliPacks operate independent of any host computer.

Key Features & Benefits

General operation

- Advanced microcontroller has integrated, downloadable flash memory and EEPROM for intelligent signal processing.
- Windows /XP/Vista/7 software configuration speeds setup and replacement.
- Push-button reprogrammability facilitates changes in the field without a host PC.
- Plug-in terminal blocks make module installation and removal easy.
- Built-in self-diagnostic routines operate upon power-up and during operation for easy maintenance and troubleshooting.
- 4-way optical isolation separates input, output, power, and relay contacts from each other.
- EMC compliant. Ruggedized circuitry meets directives to provide increased transient immunity and low emissions.
- Wide ambient temperature range ensures reliable performance from -25 to 70°C.
- Wide DC supply range with diode-coupled reverse polarity protection is useful for redundant supplies and battery backup.

Transmitter Operation

- Multi-purpose inputs accept many signal types to reduce spare stock requirements.
- User-programmable outputs let you select and change ranges to meet your needs (0-1mA, 0-20mA, 4-20mA, 0-5V, 0-10V DC).
- Intelligent signal processing functions perform mathematical computations on the input signal for customized outputs.
 - signal linearization (25 breakpoints)
 - average signal computation
 - square root computation
 - pulse counter (frequency input)
- High-resolution Sigma-Delta A/D converter delivers high accuracy with low noise.
- Relay output option provides local limit alarm capability in addition to the DC current/voltage output signal.
- High-power relays switch voltages up to 230V AC at currents up to 5A.
- User-programmable relay settings let you customize the alarm operation.
 - high or low limit setpoint
 - automatic or latching alarm reset
 - failsafe or non-failsafe operation
 - relay delay to filter transient signals
- Input excitation supply provides power for a

Acromag 
THE LEADER IN INDUSTRIAL I/O



After the initial software configuration, a PC is no longer required. Field calibration is easily handled with the IntelliPack's push-buttons, status LEDs and a standard field calibrator.

Intelligent Transfer Functions

IntelliPack transmitters support the signal processing functions listed below. The functions are easily selected via the configuration software. The next page shows sample screens for the following applications.

Signal Linearizing

IntelliPacks let you define a transfer function where the output is a function of an equation or a complex curve. The input signal is characterized using straight line approximation with a user-defined table of up to twenty-five breakpoints. Typical applications include linearizing analyzer output, flow rates, transducer non-linearities, tank characterization, and logarithmic equations.

Signal Averaging

This function provides an output signal that is a run-time average of the input signal. Input data samples are taken every 100mS. The output is computed using a user-defined number of the previous "n" samples. Applications include temperature and level measurements subject to electrical transients, air currents, agitation, and vibration.

Square Root Computation

IntelliPacks can also output a signal that is proportional to the square root of the input signal. A common use involves flowmeters where the flow rate equals the square root of the measured differential pressure. In this case, the IntelliPack output is equivalent to a linear flow rate signal that is ideal for interfacing to a standard display device.

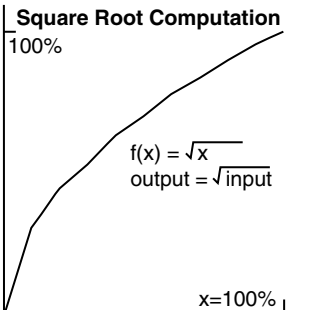
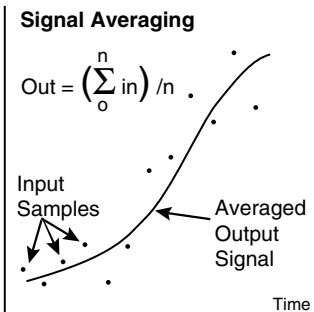
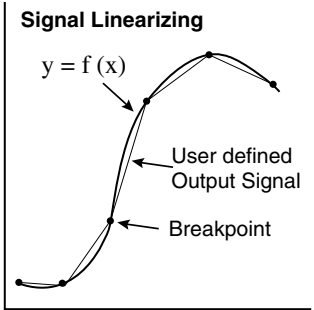

IntelliPack[®]: 800 Series

IntelliPack 800 Series Signal Conditioners



Software Configuration Examples

Square Root Computation

Linearizer/Characterizer

Proportional/Inverse

Acromag IntelliPack Configuration - 801T-1500 - Untitled*

File Module Settings Help

General Xmtr Configuration Alarm 1 Configuration Test Input Cal T-Ref Cal Output Cal

Scaling

Input 1 Range: -210 to 760 °C

Input for 0% Output: -210.0000 °C

Input for 100% Output: 760.0000 °C

Computation

None
Square Root
 Linearizer Breakpoints: 25

BP	Input %	Output %
1	0.000	0.000
2	4.167	13.053
3	8.333	25.882
4	12.500	38.267
5	16.667	50.000
6	20.833	60.876
7	25.000	70.711
8	29.167	79.335

Show Graph

For Help, press F1

Transmitter configuration property sheet.

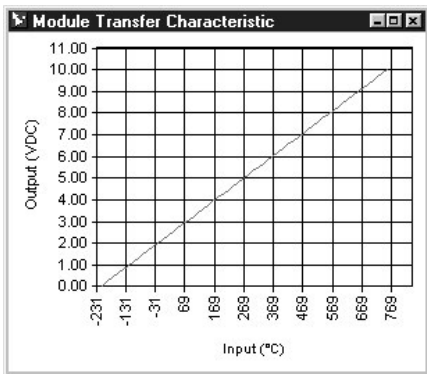

Proportional or inverse output graph.

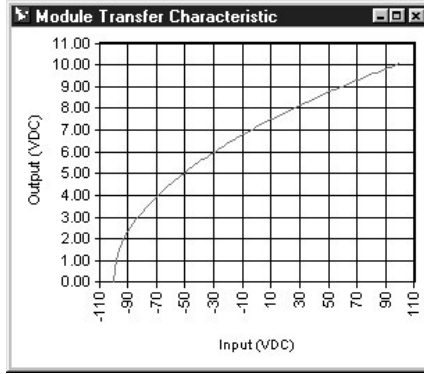

Square root transfer function graph.

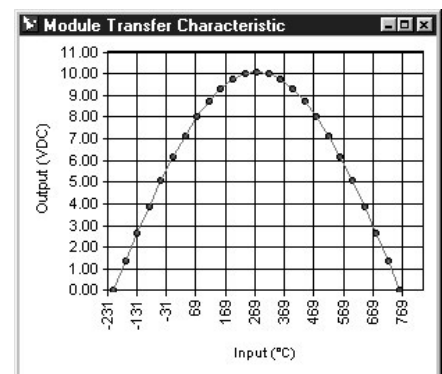

Customizable linearizer transfer function graph.

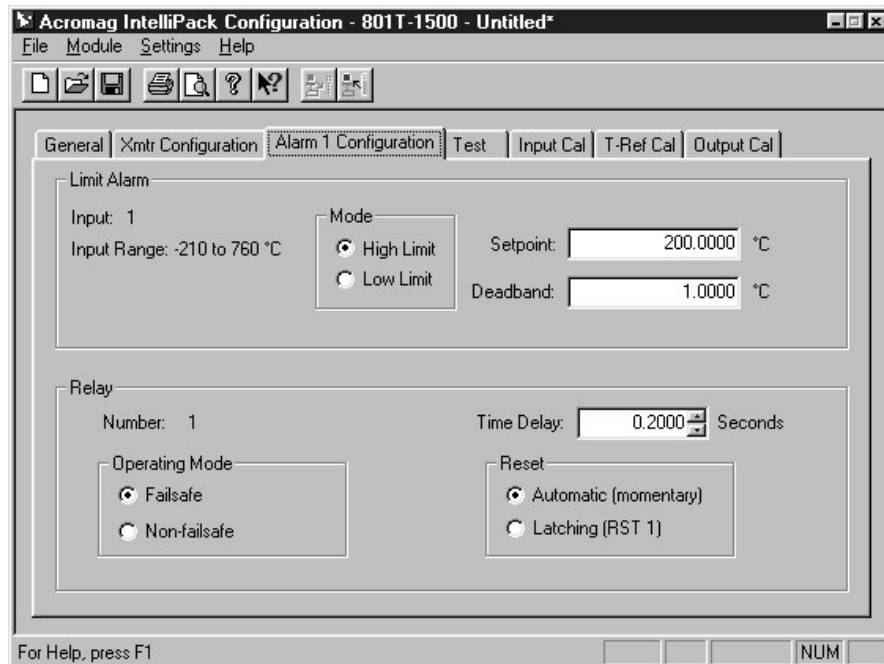

Relay Output Limit Alarm Configuration

Limit alarm property sheet.

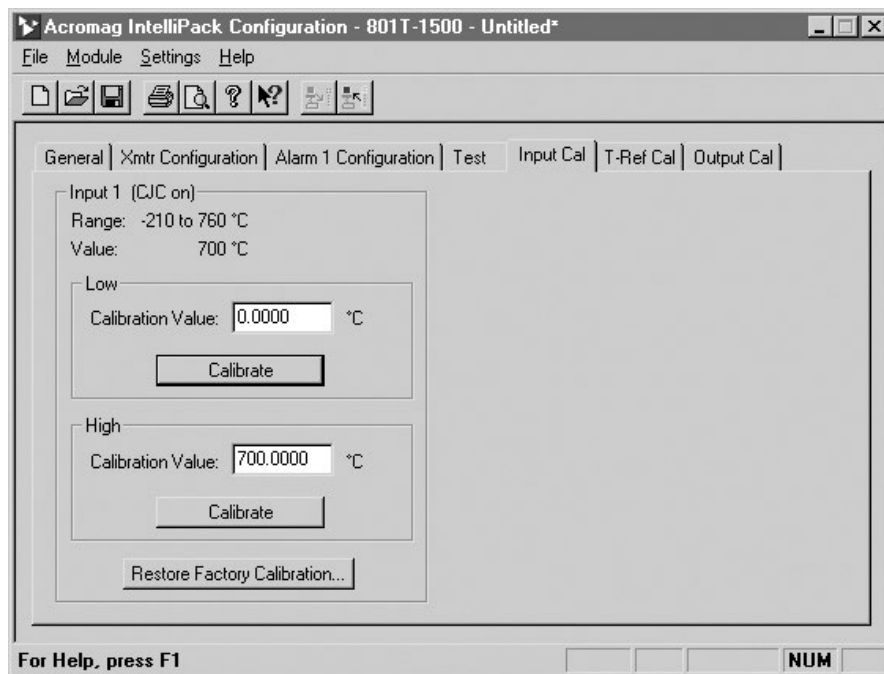

Thermocouple Reference Calibration

Thermocouple reference calibration property sheet.