

Product Datasheet - Technical Specifications



More information in our Web-Shop at ► www.meilhaus.com and in our download section.

Your contact

**Technical and commercial sales, price information,
quotations, demo/test equipment, consulting:**

Tel.: **+49 - 81 41 - 52 71-0**

FAX: **+49 - 81 41 - 52 71-129**

E-Mail: sales@meilhaus.com

Downloads:

www.meilhaus.com/en/infos/download.htm

Meilhaus Electronic GmbH
Am Sonnenlicht 2
82239 Alling/Germany

Tel. **+49 - 81 41 - 52 71-0**
Fax **+49 - 81 41 - 52 71-129**
E-Mail sales@meilhaus.com

Mentioned company and product names may be registered trademarks of the respective companies. Prices in Euro plus VAT. Errors and omissions excepted.
© Meilhaus Electronic.

www.meilhaus.de



Bridge Interface



851T Transmitters

Strain Gauge, Load Cell Input

Input

Sensor types

Load cells (4- or 6-wire configurations), Strain gauges (full-, half-, or quarter-bridge), Millivolt

Bridge/gauge resistance

Supports 85 ohms or greater with 10V excitation

Input sensitivity

Accepts load cell and strain gauge rated outputs up to 10mV/V DC

Internal excitation

Adjustable from 4 to 11V DC, 120mA max.

Output

Universal output

0 to 20mA (user-configured ranges), 0 to 10V DC (user-configured ranges),

Relay Output (optional)

5A SPDT dry contact relay

Power Requirement

12 to 36V DC

Approvals

UL, cUL listed.

Strain Gauge / Load Cell Transmitter with Alarm

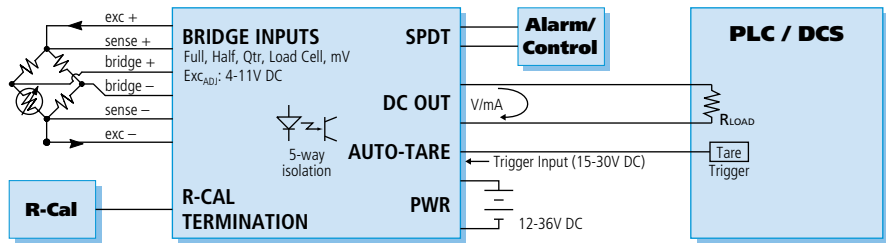

Description

IntelliPack strain gauge and load cell transmitters offer many powerful features beyond the limited capabilities found in typical bridge amplifiers. 851T models accept signals from sensors wired in a Wheatstone bridge configuration. Common uses include measurement of force, weight, level, torque, acceleration, pressure, and vibration.

The transmitter's input circuit allows true 6-wire bridge measurement and includes an adjustable bridge excitation supply (4 to 11V DC) with a remote sense feature. Sense wires ensure the programmed excitation voltage is applied at the sensor and enable lead-wire compensation. The differential input performs true ratiometric conversions for extremely stable measurements that remain accurate over time and temperature. Plus, lead break detection is inherent in the device.

IntelliPack configuration software simplifies setup for use with basic load cells, millivolt inputs, or seven bridge sensor formats. Internal bridge completion resistors are supplied for half and quarter bridges. The software also downloads sensor parameters such as gauge factor and Poisson's ratio into the transmitter for internal calculation of complex equations to determine sensor strain (ϵ). The strain is then converted to a representative process signal output.

Screw terminals enable a remote "auto-tare" function to compensate for non-zero dead weights and other sensor offsets (e.g. container weight or bridge imbalances). Alternatively, these same screw terminals may be used to reset latched relay alarms.

All these powerful features combined with Acromag's user-friendly configuration software, make the 851T a versatile device that's easy to use and maintain. Plus, a rugged, compact design makes it ideal for use out in the field, on the plant floor, or inside a laboratory.

Special Features

- Intelligent signal processing functions perform math computations for custom output:
 - strain (ϵ) calculations
 - signal linearization (25 breakpoints)
 - average signal computation
- Relay output option provides local limit alarm capability in addition to the DC output
- Adjustable bridge excitation supports a wide variety of sensor types
- An internal bridge completion function (half-to-full and quarter-to-full) accommodates a broad range of applications
- Remote auto-tare function compensates for extraneous loads and corrects for imbalances in the input bridge
- High-resolution Sigma-Delta A/D converter delivers high accuracy with low noise.
- Windows XP/Vista/7 software configuration speeds setup and replacement.

Signal Conditioners

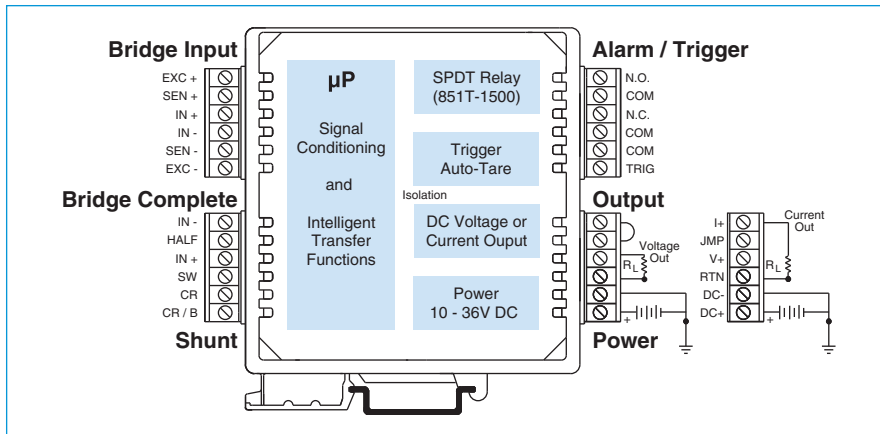

FULL-BRIDGE INPUT (INTERNAL EXCITATION)

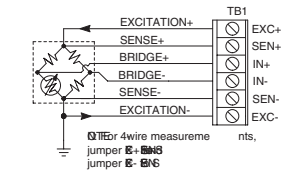

FULL-BRIDGE INPUT (EXTERNAL EXCITATION)

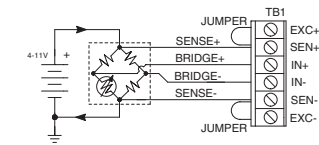

HALF-BRIDGE INPUT

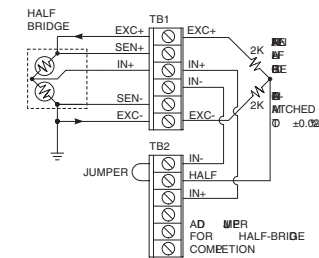

QUARTER-BRIDGE INPUT

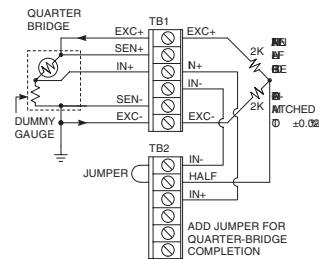

DIGITAL INPUT "TRIGGER" (AUTO-TARE/RELAY RESET)

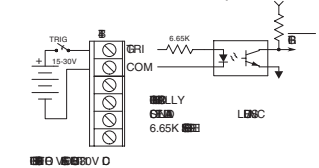

RELAY OUTPUT

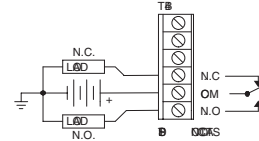

SHUNT CALIBRATION (R-CAL)

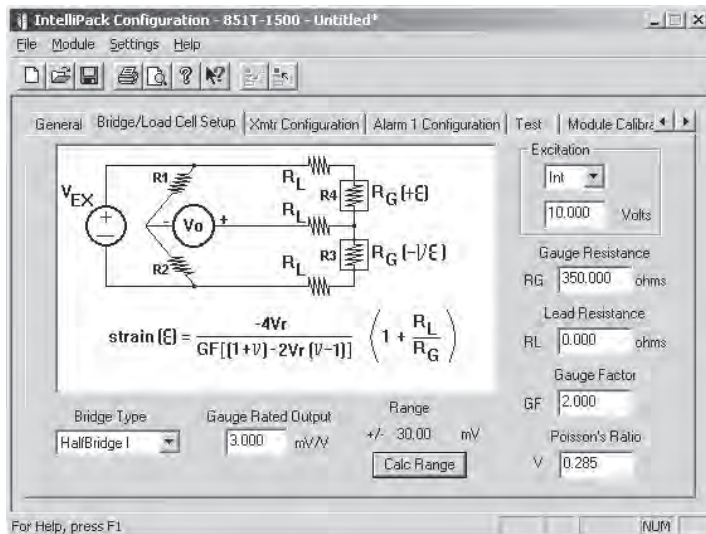
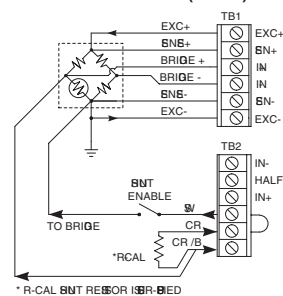

Complex strain (ϵ) calculations are easily configured and computed for full, half, and quarter-bridge sensors.

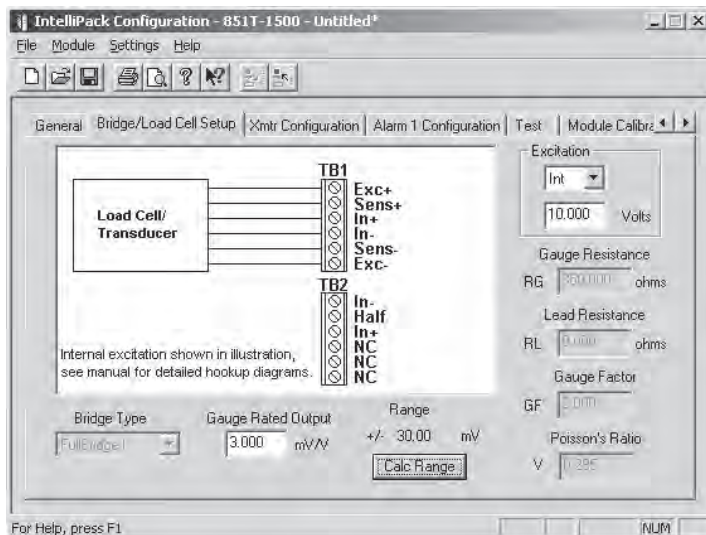

The configuration software makes it easy to set up the transmitter for use with basic load cell sensor devices. Common input sources include pressure transducers, torque converters, and vibration sensors.



851T Transmitters

■ Performance

■ General Input

Analog to Digital Converter (ADC)
16-bit Σ - Δ A/D converter.

Resolution
 $\pm 0.01\%$ of span.

Input Reference Test Conditions
120 ohm full bridge; Excitation = 10V; Rated Output = 3mV/V; Range = ± 30 mV; Ambient Temperature = 25°C; Power Supply = 24V DC; Alarm Delay = 100ms.

Accuracy (overall input to output)
Better than $\pm 0.1\%$ of span, typical.
This value does not include sensor errors.

Ambient Temperature Effect
Better than $\pm 0.01\%$ of input span per °C (± 100 ppm/°C), or ± 1.0 uV/°C, whichever is greater.

Response Time (for input step change)
250ms to 98% of final output value (into 500 ohms).

Input Overvoltage Protection
Bipolar Transient Voltage Suppressors (TVS).

■ Bridge Input

Input Types
Select from basic load cell, two quarter-bridge options, two half-bridge options, three full-bridge options, or millivolts.

Input Span/Range
Bipolar input range is determined from the \pm product of the gauge's rated output and the nominal excitation selection (2mV/V x 10V = ± 20 mV range).

Input Over-range
The actual input range is $\pm 150\%$ typical of the range obtained via the \pm product of the gauge's rated output and the nominal excitation applied.

Input Sensitivity
Accepts gauge rated outputs up to 10mV/V. The range of your input signal is the product of the excitation voltage and your gauge's rated output.

Input Impedance
 ± 1 N at 1M ohms min.; ± 5 EN at 29.09K ohms, typical.

Input Lead Resistance
Module has sufficient overdrive to guarantee 10V bridge excitation with 5 ohms/lead and 100mA of internal excitation current. Larger lead resistances may limit the maximum achievable bridge excitation.

Input Lead Break Detection
Sensor failure detection is upscale only.

Input Bridge Excitation (Internal)
Adjustable from 4V to 11V, 120mA maximum. Internal excitation may be turned OFF for external excitation supply connection.

Input Bridge Excitation (External)
4V to 11V. The internal excitation must be turned OFF for connection to an external excitation supply.

■ Digital (Trigger) Input

Input Type
"Active High" input.
15-30V DC (6.65K ohms).
See connection diagram.

Operation (Tare/Alarm Modes)
The trigger function is set for "Auto-Tare" mode by default. This input can also be configured to reset latched alarms via the Configuration Software.

■ Output (DC V/mA)

D/A Converter
16-bit Σ - Δ .

Current Output
Ranges: 0-1mA, 0-20mA, 4-20mA.
Compliance: 10V minimum (500 ohm load).

Voltage Output
Ranges: 0-5V, 0-10V.
Compliance: 10mA maximum with short circuit protection. 1 ohm output impedance.

■ Output (Relay)

Relay
One SPDT, Form C, dry contact relay.

Relay Ratings (CSA ratings)
25V DC @ 5A, resistive load.
120/240V AC @ 5A, resistive load.

Relay Time Delay
Adjustable alarm delay of up to 25 seconds.

Relay Response (No Relay Time Delay)
Relay contacts switch within 580ms typical, for an input step change from 10% of span on one side of an alarm point to 5% of span on the other side of the alarm point.

Initial Dielectric Strength
1000V AC rms between open contacts.

Contact Material
Silver-cadmium oxide (AgCdO).

Expected Mechanical Life
20 million operations.

Performance specifications continued on next page.



■ Environmental

Ambient Temperature

Operating: -25 to 70°C (-13 to 158°F).
Storage: -40 to 85°C (-40 to 185°F).

Relative Humidity

5 to 95%.

Power Requirements

12 to 36V DC. 11V DC minimum.
175mA @ 24V. 290mA @ 15V.

Isolation (optical)

5-way (input/output/relays/trigger/power).
Input, analog output, trigger, and power circuits are isolated from each other for up to 1500V AC for 60 seconds or 250V AC continuous. Optional relay outputs are isolated from other circuits up to 150V AC, or 150V DC.

Radiated Field Immunity (RFI)

EN61000-4-3, EN50082-1.

Electromagnetic Field Immunity (EMI)

Less than $\pm 0.25\%$ of output span effect under the influence of electromagnetic fields from switching solenoids, commutator motors, and drill motors.

Electrical Fast Transient (EFT)

EN61000-4-4, EN50082-1.

Surge Withstanding Capability (SWC)

EN61000-4-5, EN50082-1.

Electrostatic Discharge (ESD)

EN61000-4-2, EN50082-1.

Radiated Emissions

EN50081-1 for Class B equipment.

Approvals

UL listed (USA, Canada).
UL3121 - general product safety.

■ Configuration

Software Configuration

Units are fully programmable via the Windows XP/Vista/7 IntelliPack Configuration Program. Configuration downloads from PC through EIA232 serial port using Acromag 800C-SIP kit.

Field Configuration

Output, zero/full-scale, relay setpoint and deadband are configurable via push-buttons and a standard calibrator.

LED Indicators

LEDs indicate power, status, calibration, and alarm.

■ Physical

Enclosure

Case: Self-extinguishing NYLON type 6.6 polyamide thermoplastic UL94 V-2 NEMA Type 1 enclosure.

Connectors (Removable Terminal Blocks)

Wire Range: AWG #14-22 (AWG #12 stranded only).

Printed Circuit Boards

Military grade FR-4 epoxy glass circuit board.

Dimensions

1.05W x 4.68H x 4.35D inches.
26.7W x 118.9H x 110.5D millimeters.

Shipping Weight

1 pound (0.45 Kg) packed.

■ Ordering Information

IMPORTANT: All IntelliPacks require initial software configuration (order 800C-SIP). See Note 1 below.

851T-0500

IntelliPack transmitter unit, strain gauge input

851T-1500

Same as above, plus an SPDT relay output.

800C-SIP

Software Interface Package.

Only one kit is required for all IntelliPack models.

See diagram on Page 83 for included parts.

5034-225

USB-to-RS232 adapter. See page 121 for more info.

P55R-D24

Power supply (24V DC, 2.1A).

See Power Supplies on Page 199.

TBK-B02

Optional terminal block kit, barrier strip style, 4 pcs.

TBK-S02

Optional terminal block kit, spring clamp style, 4 pcs.

NOTE 1: To order factory configuration, call Acromag for a configuration form which must accompany your order. Also, append "-C" to model number (example: 851T-1500-C). 800C-SIP kit is still recommended.

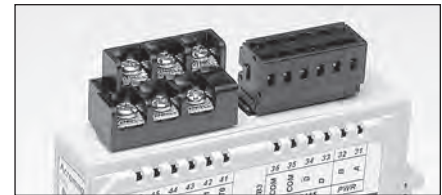

Optional terminal blocks: barrier strip (left) and spring clamp (right). Cage clamp terminal is standard.



Dimensions

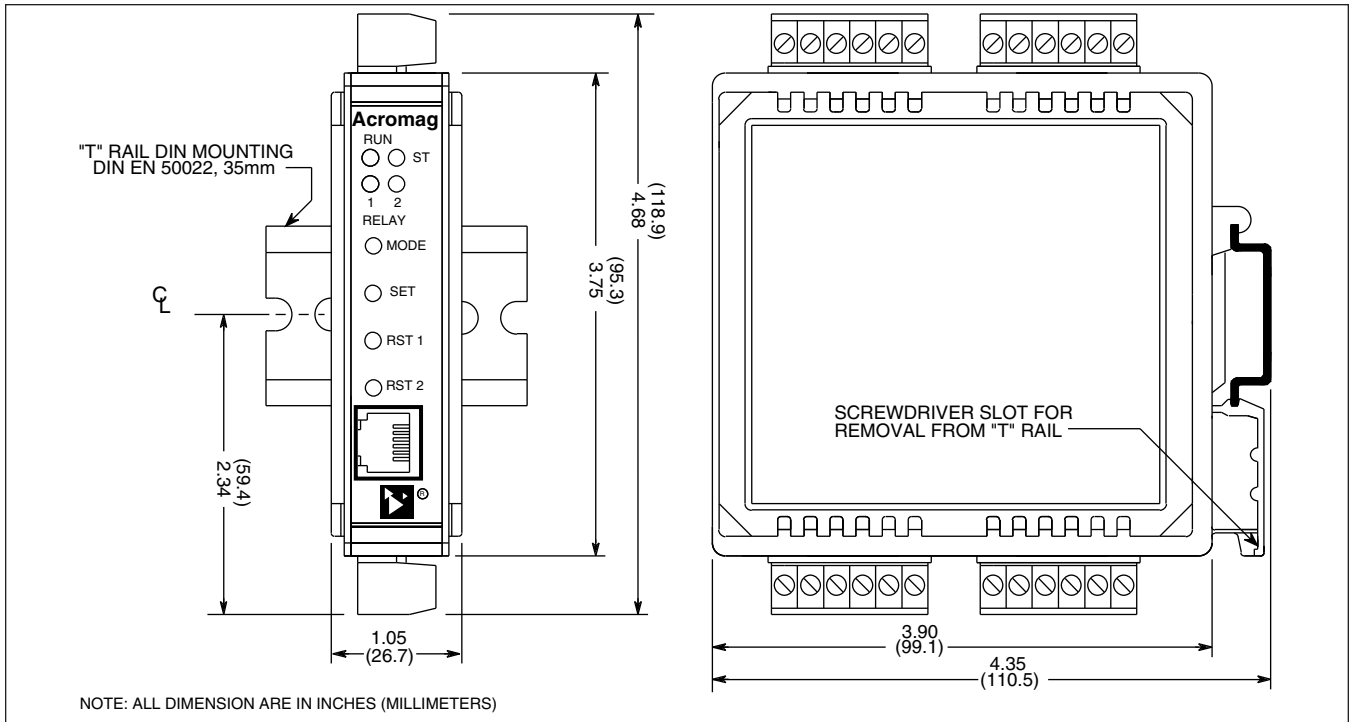



Accessories

Terminal Blocks



Barrier strip (left) and spring clamp (right).

Ordering Information

See individual I/O modules for compatibility.

Barrier Strip Terminal Blocks

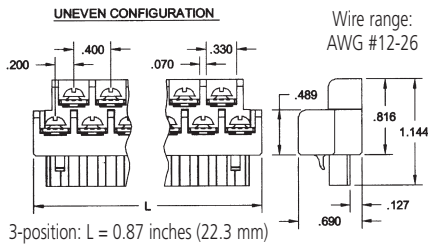
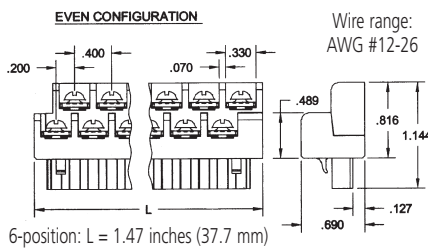

TBK-B01
Terminal block kit,
two 6-position pieces

TBK-B03
Terminal block kit,
one 3-position and
three 6-position pieces

TBK-B02
Terminal block kit,
four 6-position pieces

Spring Clamp Terminal Blocks

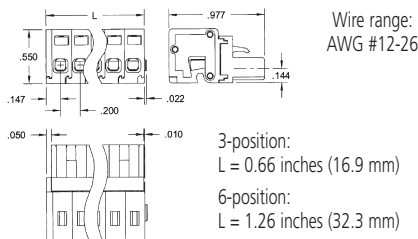

TBK-S01
Terminal block kit,
two 6-position pieces

TBK-S03
Terminal block kit,
one 3-position and
three 6-position pieces

TBK-S02
Terminal block kit,
four 6-position pieces

Mounting Hardware



DIN-Rail Mounting

For your convenience, Acromag offers several mounting accessories to simplify your system installation. Our 19" rack-mount kit provides a clean solution for mounting your I/O modules and a power supply. Or you can buy precut DIN rail strips for mounting on any flat surface.

Ordering Information

20RM-16-DIN
19" rack-mount kit with DIN rail.

DIN RAIL 3.0

DIN RAIL 16.7

DIN rail strip, Type T, 3 inches (75mm) or
16.7 inches (425mm)

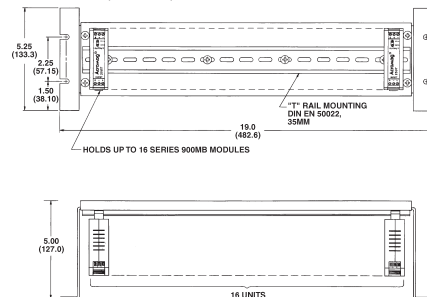

Power Supplies



50W Supply

Input Power Requirement
85 to 264V AC or 105 to 370V DC

Output
24V DC, 2.1A (50W)

Ordering Information

PS5R-D24
Universal 50W power supply

See Power Supplies on Page 199 for other models and more information.

USB / RS232 Adapter



Length: 3.15 in (8.0 cm)
Height: 0.80 in (2.03 cm)
Width: 1.75 in (4.44 cm)
Weight: 1.6 oz (45.36 g)

Ordering Information

5034-225
USB-to-RS232 adapter

AC Current Sensor

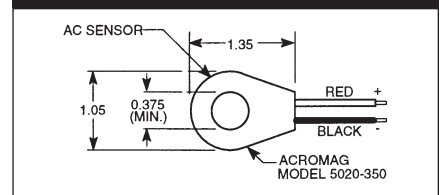

Ordering Information

5020-350
AC current sensor (See page 205)