

## Product Datasheet - Technical Specifications



More information in our Web-Shop at ► [www.meilhaus.com](http://www.meilhaus.com)

### Your contact

Technical and commercial sales, price information,  
quotations, demo/test equipment, consulting:

Tel.: **+49 - (0)81 41 - 52 71-0**

FAX: **+49 - (0)81 41 - 52 71-129**

E-Mail: [sales@meilhaus.com](mailto:sales@meilhaus.com)

**Meilhaus Electronic GmbH**  
Am Sonnenlicht 2  
82239 Alling/Germany

Tel. **+49 - (0)81 41 - 52 71-0**  
Fax **+49 - (0)81 41 - 52 71-129**  
E-Mail [sales@meilhaus.com](mailto:sales@meilhaus.com)

Mentioned company and product names may be registered trademarks of the respective companies. Errors and omissions excepted. © Meilhaus Electronic.

# IT-M3900D

## High power DC power supply



*Your Power Testing Solution*

# IT-M3900D

## High power DC power supply



IT-M3900 series integrates the features of a DC power supply, a bi-directional power supply, a source and load system, and a regenerative electronic load in one. It keeps the advantages of high power density and architecture design of M series, power up to 6kw, current up to 510A, and voltage up to 1500V within one 1U unit, effectively reducing the equipment occupation space and cabinet time. wide-range models could meet different test requirements while matching with multi-functional, high energy-saving, high-safety, and high-stability product design, let the customer be confident to face a variety of complex testing, improving the products competition ability.

The IT-M3900D series is a single channel output programmable DC power supply. The density structure design can effectively save rack space. Also with wide-range output design, can provide a wider range of voltage and current combinations within the specified power range. One unit can be used as multiple power supplies, more flexibility. The CC/CV priority allows user to switch the output mode according to the different needs of the DUT priority, match with the high-precision and high-speed product characteristics, and a variety of standard communication interfaces, simplifying and speeding up the test development, can meet users' variety testing application, widely used in laboratories, production lines, and automatic test systems.

### FEATURE

- Compact design ,power up to 6kW in 1U space, power up to 12kW in 2U space
- Voltage range: 10-1500V
- Current range: 8A~1020A
- Power range: 1700W~12kW
- Wide range of output design, one unit can be used as multiple power supplies
- With patent simple master/slave parallel connection, expand power while maintaining performance\*1
- CC/CV priority
- Adjustable output impedance
- Built-in function generator, support arbitrary-waveform generating
- List function, up to 200 steps can be set
- Support multiple working modes, adjustable rise and fall time
- The front panel supports the insertion of USB storage devices to meet the import of List files/Export, data logging functions, etc.
- Standard build-in USB/CAN/LAN/digital IO communication interface, optional GPIB/analog & RS232

\*1 If 1U models>16, 2U models>8, pls. contact ITECH.

# Your Power Testing Solution

## IT-M3900D High power DC power supply

	Model	Current	Power	Size
10V	IT-M3901D-10-170	170A	1700W	1U
	IT-M3903D-10-340	340A	3400W	1U
	IT-M3905D-10-510	510A	5100W	1U
	IT-M3910D-10-1020	1020A	10200W	2U

	Model	Current	Power	Size
32V	IT-M3902D-32-80	80A	2kW	1U
	IT-M3904D-32-160	160A	4kW	1U
	IT-M3906D-32-240	240A	6kW	1U
	IT-M3912D-32-480	480A	12kW	2U

	Model	Current	Power	Size
80V	IT-M3902D-80-40	40A	2kW	1U
	IT-M3904D-80-80	80A	4kW	1U
	IT-M3906D-80-120	120A	6kW	1U
	IT-M3912D-80-240	240A	12kW	2U

	Model	Current	Power	Size
300V	IT-M3902D-300-20	20A	2kW	1U
	IT-M3904D-300-40	40A	4kW	1U
	IT-M3906D-300-60	60A	6kW	1U
	IT-M3912D-300-120	120A	12kW	2U

	Model	Current	Power	Size
500V	IT-M3902D-500-12	12A	2kW	1U
	IT-M3904D-500-24	24A	4kW	1U
	IT-M3906D-500-36	36A	6kW	1U
	IT-M3912D-500-72	72A	12kW	2U

	Model	Current	Power	Size
800V	IT-M3902D-800-8	8A	2kW	1U
	IT-M3904D-800-16	16A	4kW	1U
	IT-M3906D-800-24	24A	6kW	1U
	IT-M3912D-800-48	48A	12kW	2U

	Model	Current	Power	Size
1500V	IT-M3906D-1500-12	12A	6kW	1U

\*This information is subject to change without notice.

## Application

Electrolytic plating

Water treatment, surface coating, plating

5G Communications & Data Centre

Server power supply, UPS inverter unit

Semiconductor field

Ion injection, MOCVD power supply

Industrial component

Fuses, automotive connector, current sensor

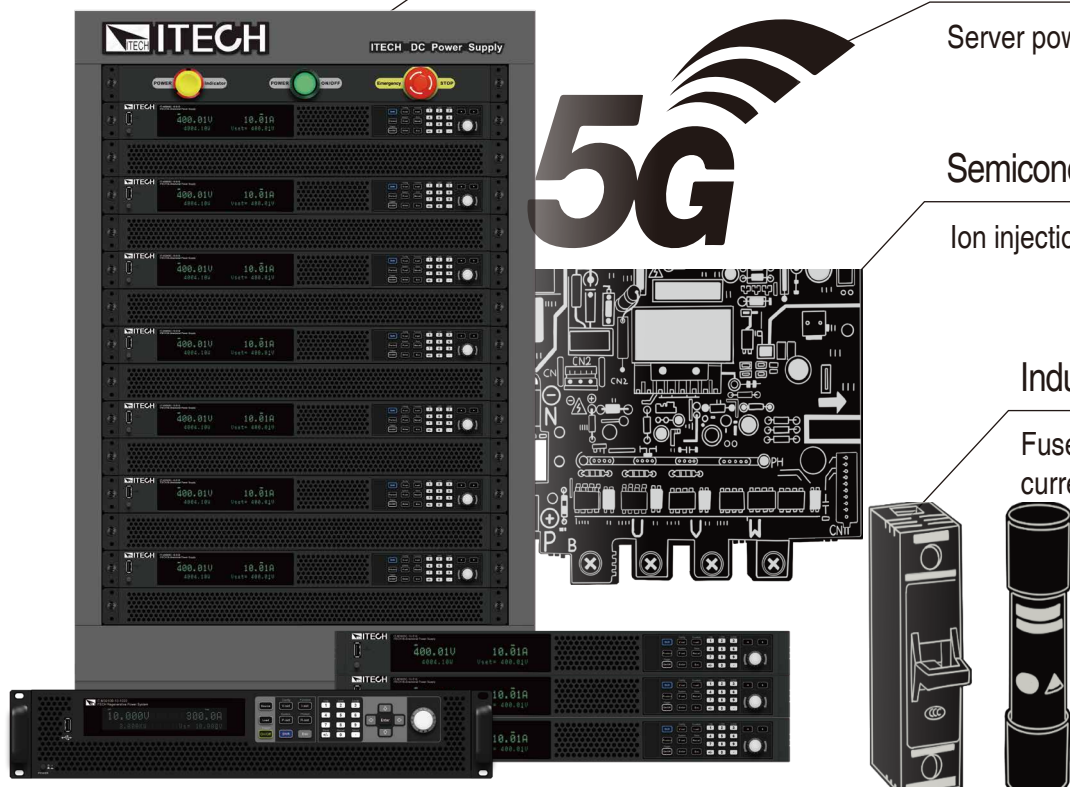

# Your Power Testing Solution

## IT-M3900D High power DC power supply

### High power density, compact design

ITECH has always adhered to the design concept of high power density to help users optimize the test solutions. The IT-M3900D series adopts a compact structure design to effectively save rack space, and provide up to 6kW power output in a 1U chassis, up to 12kW power output in a 2U chassis, which makes the entire portfolio of ITECH high power density series more complete and comprehensive.



 Reduced volume by 2/3

ITECH IT-M3900D series

1U

# VS

Testing solution for 6kW

Other power supplies

3U

### Wide range output

There are 25 models included in IT-M3900C series. The output voltage ranges from 10V to 1500V and the maximum output current of a single unit can reach 1020A. The wide-range output design provides more voltage and current combinations than conventional fixed-range output DC power supplies, which is more flexible. Just a single unit can cover a wide range of applications which makes it easy to build power systems and largely save room for you at the same time.

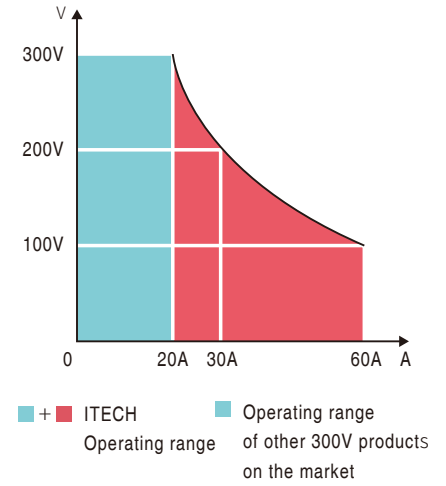
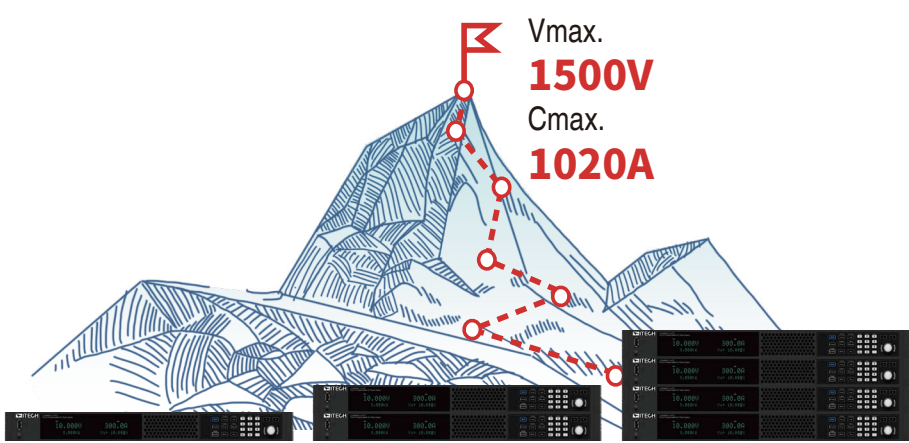



### CC&CV priority function

CC/CV priority can continue to help users solve various severe problems in long-term test applications to make applications that require high-speed power or non-overshoot more flexible. The CC&CV priority function of IT-M3900D allows the user to select the response speed and the loop working mode of the CC/CV loop to determine whether the output is high-speed voltage mode or non-overshoot current mode, which is suitable for high-power integrated circuit testing, charging and discharging testing, power transient simulation and characterization of automotive electronics, etc.

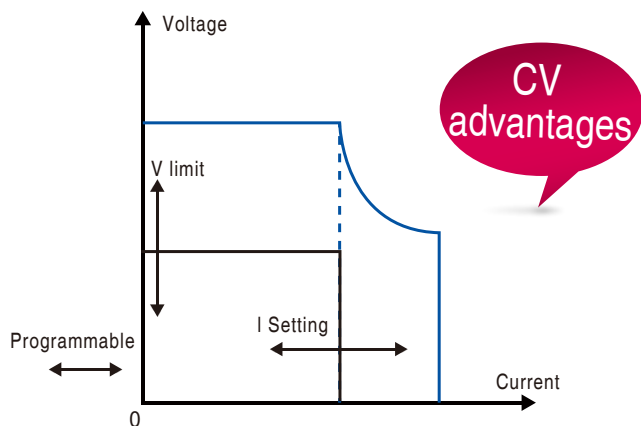

Start surge current over current range to build voltage at high speed  
(CV-High, CC-Low, CV advantages)

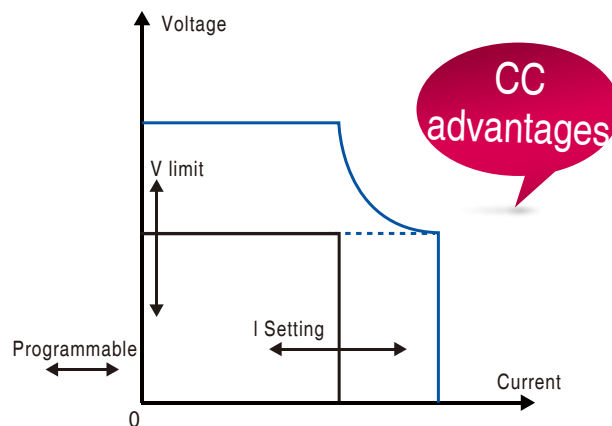

High-speed and seamless battery charging and discharging, no overshoot switching  
(CV-High, CC-High, CC advantages)

### Applications

Diode, laser diode, LED, power semiconductor component testing

When facing a diode load, users can easily set the CC priority mode test in the menu. Advantages: The conventional power supply defaults to the CV loop priority, Therefore, the speed of suppressing the current overshoot at the moment of starting is slower. The CC/CV priority allows users to adjust the loop speed according to test requirements, such as setting it in CC priority mode to avoid output overshoot.



Diode load  
Conventional power test

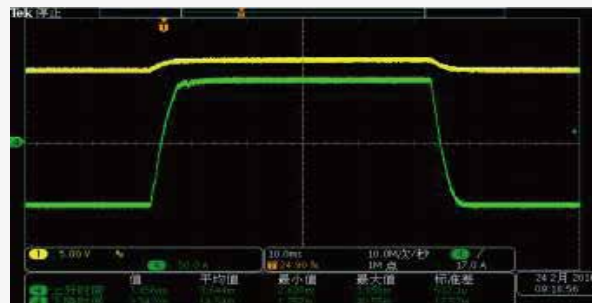

Diode load  
IT-M3900D CC priority mode

# Your Power Testing Solution

## IT-M3900D High power DC power supply

### High efficiency parallel connection technology

Considering the user's convenience and versatility, IT-M3900d can use master/slave control mode to parallel 6 units or more. Meanwhile ITECH patented fiber optic parallel technology fully solve the problems of slow speed and poor accuracy of traditional parallel methods. It is suitable for calibration and measurement, R&D lab, production line and ATE test.

The parameters will not change after parallel connection

Calibration is not requested after parallel connection

Optical fiber transfer between master and slave, guarantee perfect performance of anti-interference

Adopt Optical fiber isolation technology, effective protection of the device and DUT

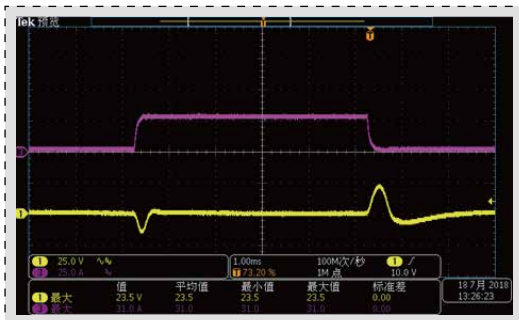

Single Unit

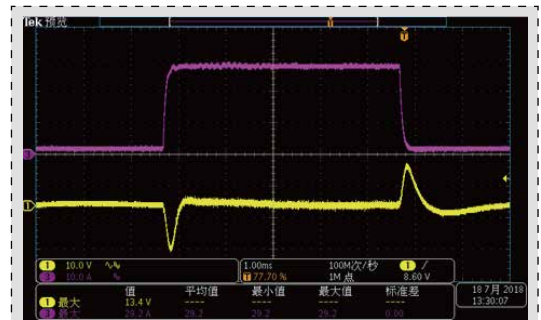

Parallel unit



### Applications

Electrolytic plating, Sewage treatment, Surface coating, Sputtering, Hydrogen production from electrolytic water

Recommendation: :IT-M3906D-32-240 \*5 units in parallel

Advantages: ① low voltage high current output to meet the demand of ultra-high current test; ② small size high power density, 32V in 1U can reach 240A ③ High accuracy of current output, electroplating current can be arbitrarily configured according to requirements. The output is stable and reliable.

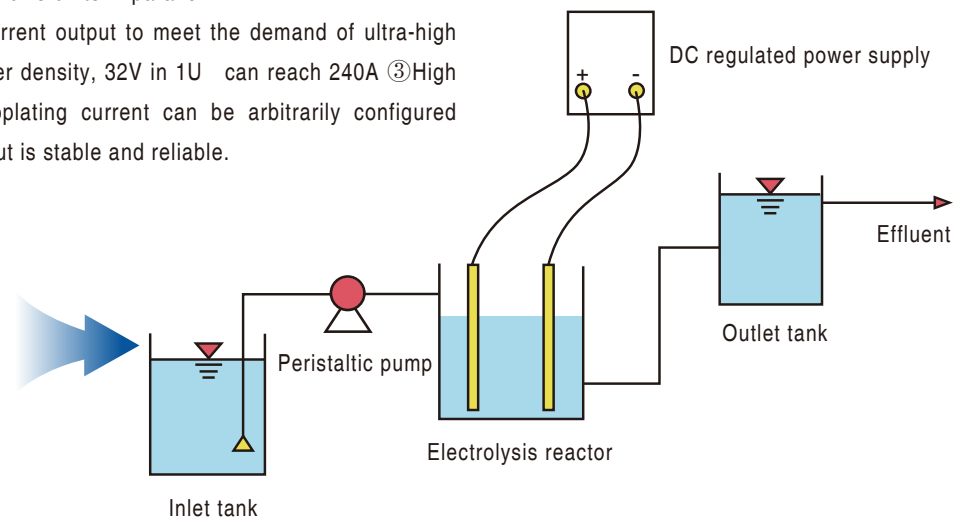

# Your Power Testing Solution

## IT-M3900D High power DC power supply

### Multiple interfaces

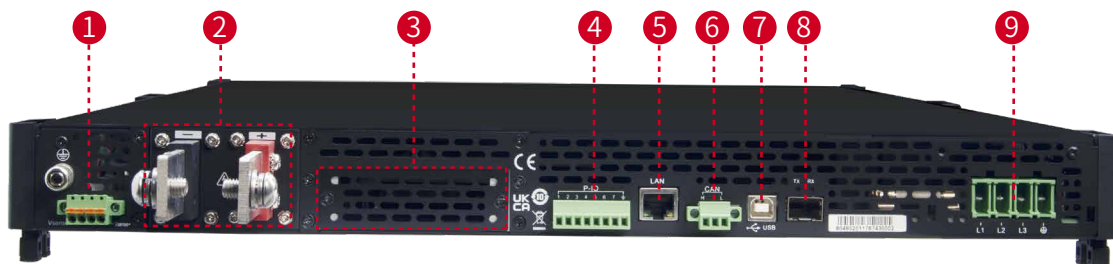

<p><b>1</b> Sense terminals (Vs+, Vs-)</p>	<p><b>2</b> DC output terminals of the power supply</p>	<p><b>3</b> Interface for optional accessories</p>	<p><b>4</b> Digital I/O interface: P-IO</p>	<p><b>5</b> LAN Communication Interface</p>
<p><b>6</b> CAN Communication Interface</p>	<p><b>7</b> USB Communication Interface</p>	<p><b>8</b> Communication interface of outer ring optical fiber (TX and RX)</p>	<p><b>9</b> AC power input terminals (L1, L2, L3, and PE)</p>	

### Optional Accessories

Category	Model	Specification	Description
Parallel kit	IT-E4029-15U	IT15U cabinet	800mm×550mm X907.6mm
	IT-E4029-27U	IT27U cabinet	800mm×600mm×1362.75mm
	IT-E4029-37U	IT27U cabinet	800mm×600mm×1764.35mm
	IT-E168	Optical fiber cable kit	Connection between the units in a cabinet
	IT-E155A/B/C	Cabinet rack mount Kit	Cabinet rack mount installation
Functional Module	IT-E165A-250 <sup>*1</sup>	Anti-reverse protection unit 750V/250A	avoid reverse connection
	IT-E165A-400 <sup>*1</sup>	Anti-reverse protection unit 750V/400A	avoid reverse connection
	IT-E165A-500 <sup>*1</sup>	Anti-reverse protection unit 900V/400A	avoid reverse connection
	IT-E165B <sup>*2</sup>	Anti electromotive force protection unit	avoid current back flow
Other accessories	IT-E258	5m power cord for 3U unit, CN standard	AC input power cord
	IT-E258-15U	5m power cord for 15U unit, CN standard	AC input power cord
	IT-E258-27U	5m power cord for 27U unit, CN standard	AC input power cord
	IT-E258-37U	5m power cord for 37U unit, CN standard	AC input power cord
	IT-E176	GPIB communication interface	
	IT-E177	RS232&analog communication card	

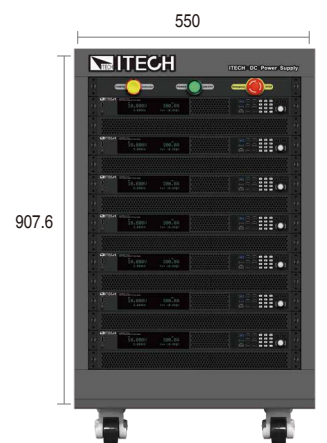

IT-E4029-15U (Dimension:mm)

\*1 The voltage/current of the DUT must be within the IT-E165A rated range

\*2 The voltage/current of the DUT must be within the IT-E165B rated range



# Your Power Testing Solution

## IT-M3900D High power DC power supply

### Specification

		IT-M3905D-10-510	IT-M3906D-32-240
Input Rating	Voltage	0~10V	0~32V
	Current	0~510A	0~240A
	Power	0~5100W	0~6000W
	Series Resistance (CV priority mode)	0~0.02Ω	0~0.2Ω
Input Resolution	Voltage	0.001V	0.001V
	Current	0.1A	0.01A
	Power	1W	1W
	Series Resistance (CV priority mode)	0.001Ω	0.001Ω
Readback Resolution	Voltage	0.001V	0.001V
	Current	0.1A	0.01A
	Power	1W	1W
Setup Accuracy	Voltage	≤0.03% + 0.03%FS	≤0.03% + 0.03%FS
	Current	≤0.1% + 0.1%FS	≤0.1% + 0.1%FS
	Power	≤0.5% + 0.5%FS	≤0.5% + 0.5%FS
	Series Resistance (CV priority mode)	≤1%FS	≤1%FS
Readback Accuracy	Voltage	≤0.03% + 0.03%FS	≤0.03% + 0.03%FS
	Current	≤0.1% + 0.1%FS	≤0.1% + 0.1%FS
	Power	≤0.5% + 0.5%FS	≤0.5% + 0.5%FS
Ripple	Voltage Peak Value	≤65mVpp	≤80mVpp
	Voltage RMS	≤10mV	≤30mV
Input Drift Temperature Coefficient	Voltage	≤50ppm/°C	≤50ppm/°C
	Current	≤50ppm/°C	≤50ppm/°C
Readback Drift Temperature Coefficient	Voltage	≤50ppm/°C	≤50ppm/°C
	Current	≤50ppm/°C	≤50ppm/°C
Rising Time (no load)	Voltage	≤50ms	≤15ms
Rising Time (full load)	Voltage	≤100ms	≤30ms
Falling Time (no load)	Voltage	≤50ms	≤30ms
Falling Time (full load)	Voltage	≤100ms	≤15ms
Dynamic Response Time	Voltage	≤10ms	≤1ms <sup>*1</sup>
Power Regulation Rate	Voltage	≤0.05% + 0.05%FS	≤0.02% + 0.02%FS
	Current	≤0.05% + 0.05%FS	≤0.05% + 0.05%FS
Load Regulation Rate	Voltage	0.0035% <sup>*1</sup> + 0.05%FS	≤0.02% + 0.02%FS
	Current	≤0.05% + 0.05%FS	≤0.05% + 0.05%FS
Input Protection Scope	OCP	520A	250A
	OVP	10.5V	33V
	OPP	5202W	6120W
Remote Sense Compensation Voltage		≤2V	≤2V
AC Input <sup>*2</sup>	Voltage	3φ 110V~520V 1φ 85V~300V	3φ 110V~520V 1φ 85V~300V
	Frequency	50/60Hz	50/60Hz
Max. AC Apparent Power		5.55kVA	6.5kVA
Max. AC Current		12.5Aac	12.5Aac
Max. Efficiency		92%	92%
Power Factor		0.99	0.99
DC Component		≤0.2A	≤0.2A
Current Harmonic		≤3%	≤3%
Programming Response Time		0.1ms	0.1ms
Withstand Voltage (DC to ground)		300Vdc	300Vdc
Withstand Voltage (AC to ground)		3500Vdc	3500Vdc
Dimension		660mm*437mm*43.5mm	660mm*437mm*43.5mm
N.W.		15kg	15kg

<sup>\*1</sup> 25%-90% rated current <sup>\*2</sup> The rated power will be decreased under low level voltage input

\* This information is subject to change without notice.

# Your Power Testing Solution

## IT-M3900D High power DC power supply

### Specification

		IT-M3906D-80-120	IT-M3906D-300-60
Input Rating	Voltage	0 ~ 80V	0 ~ 300V
	Current	0 ~ 120A	0 ~ 60A
	Power	0 ~ 6000W	0 ~ 6000W
	Series Resistance (CV priority mode)	0 ~ 0.3Ω	0 ~ 1Ω
Input Resolution	Voltage	0.001V	0.01V
	Current	0.01A	0.001A
	Power	1W	1W
	Series Resistance (CV priority mode)	0.001Ω	0.001Ω
Readback Resolution	Voltage	0.001V	0.01V
	Current	0.01A	0.001A
	Power	1W	1W
Setup Accuracy	Voltage	≤ 0.03% + 0.03%FS	≤ 0.03% + 0.03%FS
	Current	≤ 0.1% + 0.1%FS	≤ 0.1% + 0.1%FS
	Power	≤ 0.5% + 0.5%FS	≤ 0.5% + 0.5%FS
	Series Resistance (CV priority mode)	≤ 1%FS	≤ 1%FS
Readback Accuracy	Voltage	≤ 0.03% + 0.03%FS	≤ 0.03% + 0.03%FS
	Current	≤ 0.1% + 0.1%FS	≤ 0.1% + 0.1%FS
	Power	≤ 0.5% + 0.5%FS	≤ 0.5% + 0.5%FS
Ripple	Voltage Peak Value	≤ 200mVpp	≤ 300mVpp
	Voltage RMS	≤ 80mV	≤ 100mV
Input Drift Temperature Coefficient	Voltage	≤ 50ppm/°C	≤ 50ppm/°C
	Current	≤ 50ppm/°C	≤ 50ppm/°C
Readback Drift Temperature Coefficient	Voltage	≤ 50ppm/°C	≤ 50ppm/°C
	Current	≤ 50ppm/°C	≤ 50ppm/°C
Rising Time (no load)	Voltage	≤ 15ms	≤ 15ms
Rising Time (full load)	Voltage	≤ 30ms	≤ 30ms
Falling Time (no load)	Voltage	≤ 15ms	≤ 30ms
Falling Time (full load)	Voltage	≤ 30ms	≤ 15ms
Dynamic Response Time	Voltage	≤ 1ms <sup>*1</sup>	≤ 1ms <sup>*1</sup>
Power Regulation Rate	Voltage	≤ 0.01% + 0.01%FS	≤ 0.01% + 0.01%FS
	Current	≤ 0.05% + 0.05%FS	≤ 0.05% + 0.05%FS
Load Regulation Rate	Voltage	≤ 0.01% + 0.01%FS	≤ 0.01% + 0.01%FS
	Current	≤ 0.05% + 0.05%FS	≤ 0.05% + 0.05%FS
Input Protection Scope	OCP	125A	63A
	OVP	82V	303V
	OPP	6120W	6120W
Remote Sense Compensation Voltage		≤ 2V	≤ 3V
AC Input <sup>*2</sup>	Voltage	3φ 110V ~ 520V 1φ 85V ~ 300V	3φ 110V ~ 520V 1φ 85V ~ 300V
	Frequency	50/60Hz	50/60Hz
Max. AC Apparent Power		6.5kVA	6.5kVA
Max. AC Current		12.5Aac	12.5Aac
Max. Efficiency		92%	94.5%
Power Factor		0.99	0.99
DC Component		≤ 0.2A	≤ 0.2A
Current Harmonic		≤ 3%	≤ 3%
Programming Response Time		0.1ms	0.1ms
Withstand Voltage (DC to ground)		300Vdc	600Vdc
Withstand Voltage (AC to ground)		3500Vdc	3500Vdc
Dimension		660mm*437mm*43.5mm	660mm*437mm*43.5mm
N.W.		15kg	15kg

\*1 25%-90% rated current \*2 The rated power will be decreased under low level voltage input

\* This information is subject to change without notice.

# Your Power Testing Solution

## IT-M3900D High power DC power supply

### Specification

		IT-M3906D-500-36	IT-M3906D-800-24
Input Rating	Voltage	0~500V	0~800V
	Current	0~36A	0~24A
	Power	0~6000W	0~6000W
	Series Resistance (CV priority mode)	0~1Ω	0~1Ω
Input Resolution	Voltage	0.01V	0.01V
	Current	0.001A	0.001A
	Power	1W	1W
	Series Resistance (CV priority mode)	0.01Ω	0.01Ω
Readback Resolution	Voltage	0.01V	0.01V
	Current	0.001A	0.001A
	Power	1W	1W
Setup Accuracy	Voltage	≤ 0.03% + 0.03%FS	≤ 0.03% + 0.03%FS
	Current	≤ 0.1% + 0.1%FS	≤ 0.1% + 0.1%FS
	Power	≤ 0.5% + 0.5%FS	≤ 0.5% + 0.5%FS
	Series Resistance (CV priority mode)	≤ 1%FS	≤ 1%FS
Readback Accuracy	Voltage	≤ 0.03% + 0.03%FS	≤ 0.03% + 0.03%FS
	Current	≤ 0.1% + 0.1%FS	≤ 0.1% + 0.1%FS
	Power	≤ 0.5% + 0.5%FS	≤ 0.5% + 0.5%FS
Ripple	Voltage Peak Value	≤ 500mVpp	≤ 800mVpp
	Voltage RMS	≤ 200mV	≤ 300mV
Input Drift Temperature Coefficient	Voltage	≤ 50ppm/°C	≤ 50ppm/°C
	Current	≤ 50ppm/°C	≤ 50ppm/°C
Readback Drift Temperature Coefficient	Voltage	≤ 50ppm/°C	≤ 50ppm/°C
	Current	≤ 50ppm/°C	≤ 50ppm/°C
Rising Time (no load)	Voltage	≤ 15ms	≤ 15ms
Rising Time (full load)	Voltage	≤ 30ms	≤ 30ms
Falling Time (no load)	Voltage	≤ 30ms	≤ 30ms
Falling Time (full load)	Voltage	≤ 15ms	≤ 15ms
Dynamic Response Time	Voltage	≤ 1ms <sup>*1</sup>	≤ 1ms <sup>*1</sup>
Power Regulation Rate	Voltage	≤ 0.01% + 0.01%FS	≤ 0.01% + 0.01%FS
	Current	≤ 0.05% + 0.05%FS	≤ 0.05% + 0.05%FS
Load Regulation Rate	Voltage	≤ 0.01% + 0.01%FS	≤ 0.01% + 0.01%FS
	Current	≤ 0.05% + 0.05%FS	≤ 0.05% + 0.05%FS
Input Protection Scope	OCP	37A	25A
	OVP	505V	808V
	OPP	6120W	6120W
Remote Sense Compensation Voltage		≤ 5V	≤ 8V
AC Input <sup>*2</sup>	Voltage	3φ 110V~520V 1φ 85V~300V	3φ 110V~520V 1φ 85V~300V
	Frequency	50/60Hz	50/60Hz
Max. AC Apparent Power		6.5kVA	6.5kVA
Max. AC Current		12.5Aac	12.5Aac
Max. Efficiency		94.5%	94.5%
Power Factor		0.99	0.99
DC Component		≤ 0.2A	≤ 0.2A
Current Harmonic		≤ 3%	≤ 3%
Programming Response Time		0.1ms	0.1ms
Withstand Voltage (DC to ground)		800Vdc	1000Vdc
Withstand Voltage (AC to ground)		3500Vdc	3500Vdc
Dimension		660mm*437mm*43.5mm	660mm*437mm*43.5mm
N.W.		15kg	15kg

\*1 25%-90% rated current \*2 The rated power will be decreased under low level voltage input

\* This information is subject to change without notice.

# Your Power Testing Solution

## IT-M3900D High power DC power supply

### Specification

		IT-M3906D-1500-12
Input Rating	Voltage	0~1500V
	Current	0~12A
	Power	0~6000W
	Series Resistance (CV priority mode)	0~1Ω
Input Resolution	Voltage	0.01V
	Current	0.001A
	Power	1W
	Series Resistance (CV priority mode)	0.01Ω
Readback Resolution	Voltage	0.01V
	Current	0.001A
	Power	1W
Setup Accuracy	Voltage	≤ 0.03% + 0.03%FS
	Current	≤ 0.1% + 0.1%FS
	Power	≤ 0.5% + 0.5%FS
	Series Resistance (CV priority mode)	≤ 1%FS
Readback Accuracy	Voltage	≤ 0.03% + 0.03%FS
	Current	≤ 0.1% + 0.1%FS
	Power	≤ 0.5% + 0.5%FS
Ripple	Voltage Peak Value	≤ 1500mVpp
	Voltage RMS	≤ 500mV
Input Drift Temperature Coefficient	Voltage	≤ 50ppm/°C
	Current	≤ 50ppm/°C
Readback Drift Temperature Coefficient	Voltage	≤ 50ppm/°C
	Current	≤ 50ppm/°C
Rising Time (no load)	Voltage	≤ 15ms
Rising Time (full load)	Voltage	≤ 30ms
Falling Time (no load)	Voltage	≤ 30ms
Falling Time (full load)	Voltage	≤ 15ms
Dynamic Response Time	Voltage	≤ 1ms <sup>*1</sup>
Power Regulation Rate	Voltage	≤ 0.01% + 0.01%FS
	Current	≤ 0.05% + 0.05%FS
Load Regulation Rate	Voltage	≤ 0.01% + 0.01%FS
	Current	≤ 0.05% + 0.05%FS
Input Protection Scope	OCP	-12.5A or 12.5A
	OVP	1515V
	OPP	6120W
Remote Sense Compensation Voltage		≤ 15V
AC Input <sup>*2</sup>	Voltage	3φ 110V~520V 1φ 85V~300V
	Frequency	50/60Hz
Max. AC Apparent Power		6.5kVA
Max. AC Current		12.5Aac
Max. Efficiency		94.5%
Power Factor		0.99
DC Component		≤ 0.2A
Current Harmonic		≤ 3%
Programming Response Time		0.1ms
Withstand Voltage (DC to ground)		1800Vdc
Withstand Voltage (AC to ground)		3500Vdc
Dimension		660mm*437mm*43.5mm
N.W.		15kg

\*1 25%-90% rated current \*2 The rated power will be decreased under low level voltage input

\* This information is subject to change without notice.