

Product Datasheet - Technical Specifications



More information in our Web-Shop at ► www.meilhaus.com

Your contact

Technical and commercial sales, price information,
quotations, demo/test equipment, consulting:

Tel.: +49 - (0)81 41 - 52 71-0

E-Mail: sales@meilhaus.com

Meilhaus Electronic GmbH
Am Sonnenlicht 2
82239 Alling/Germany

Tel. +49 - (0)81 41 - 52 71-0 E-
Mail sales@meilhaus.com

Mentioned company and product names may be registered trademarks of the respective companies. Errors and omissions excepted. © Meilhaus Electronic.

Digital Storage Oscilloscope

MDO Series

- ▶ Max. 500 MHz bandwidth
- ▶ 3 GSa/s sampling rate, 4 analog channels
- ▶ 360 Mpts memory depth
- ▶ 14" touch screen, 1920 x 1200 resolution

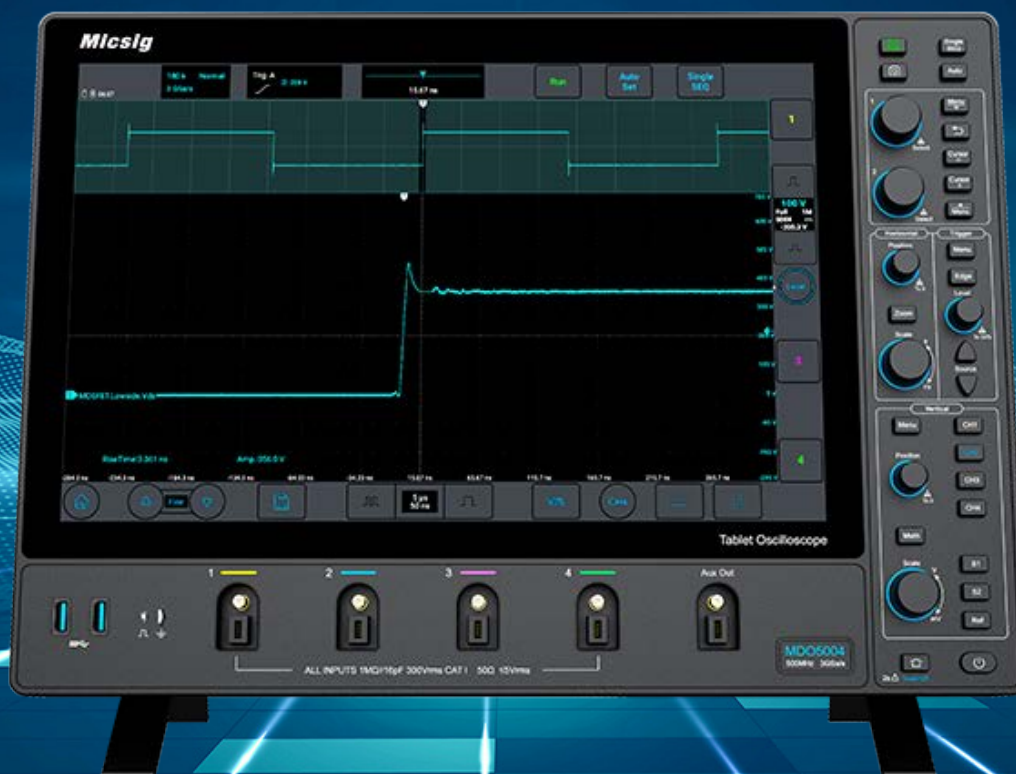

Product Overview

The MDO series digital storage oscilloscope is a bench-top oscilloscope that features 4 analog channels, max. 500MHz bandwidth, 3GSa/s real-time sampling rate, and 360Mpts memory depth. With 3.58cm ultra-thin design, it supports wall / arm mounting; 14-inch touchscreen with highest resolution of 1920 x 1200, brings ultimate clear waveform display.

Product Features



- ▶ Max. 500MHz bandwidth
- ▶ Up to 360Mpts memory depth
- ▶ Simultaneous data saving on multi-channel
- ▶ High / Low pass bandwidth filtering
- ▶ Noise floor < 90 μ Vrms
- ▶ Standard segmented storage function
- ▶ Advanced math and FFT function
- ▶ 230,000 wfms/s waveform capture rate
- ▶ 14" anti-glare touch screen, 1920 x 1200 resolution
- ▶ Ultra-friendly UI, get to use in 5 minutes
- ▶ Mic-OPI™ probe interface, auto-match attenuation
- ▶ Mobile APP, PC remote control, SCPI commands
- ▶ 32G internal storage to save big data
- ▶ Standard decodes: RS-232/422/485/UART, CAN, CAN FD, LIN, SPI, I²C, ARINC-429, MIL-STD-1553B

Wall mounting

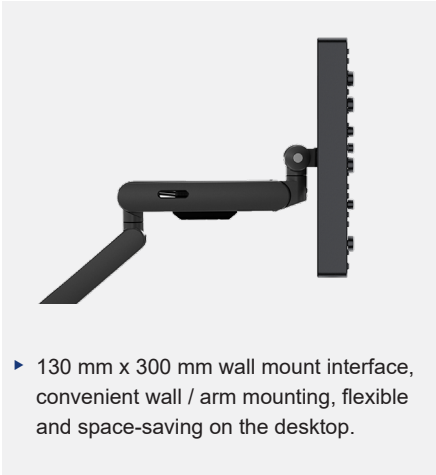

- ▶ 130 mm x 300 mm wall mount interface, convenient wall / arm mounting, flexible and space-saving on the desktop.

Remote control



- ▶ MDO series support PC and smartphone remote control, also have HDMI port for demonstration purpose. Support SCPI programming commands control, helping engineers achieve automated measurements more flexibly and efficiently.

Various Interfaces

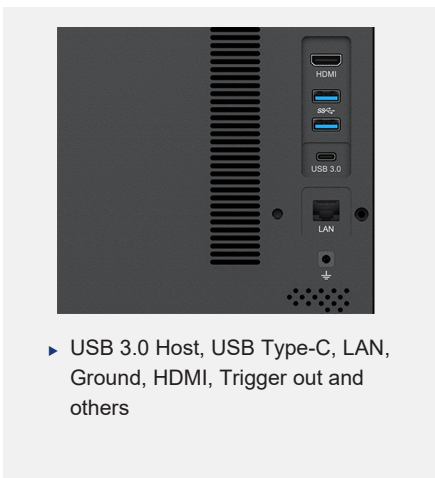

- ▶ USB 3.0 Host, USB Type-C, LAN, Ground, HDMI, Trigger out and others

Mic-OPI™ probe interface

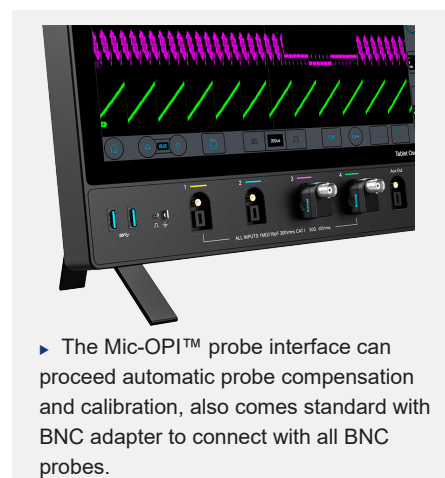

- ▶ The Mic-OPI™ probe interface can proceed automatic probe compensation and calibration, also comes standard with BNC adapter to connect with all BNC probes.

Key Specifications

Model	MDO5004	MDO3504	MDO2504
Bandwith	500MHz	350MHz	250MHz
Rise time	≤ 0.7ns	≤ 1ns	≤ 1.4ns
Analog channels	4	4	4
Sampling rate	3GSa/s	3GSa/s	3GSa/s
Memory depth	360Mpts	360Mpts	360Mpts
Waveform capture rate	230,000 wfms/s	230,000 wfms/s	230,000 wfms/s
Vertical resolution	8 bits		
Noise	< 90μVrms		
Bus decoding (std.)	RS-232/422/485/UART, CAN, CAN FD, LIN, SPI, I ² C, ARINC-429, MIL-STD-1553B		
Interfaces	USB 3.0 Host, USB type-C, LAN, HDMI, Trigger out		
Display	14" TFT LCD touch screen, 1920*1200 resolution		
Trigger types	Edge, Pulse Width, Logic, Nth Edge, Runt, Slope, Time Out, Video, Serial		

Product Features

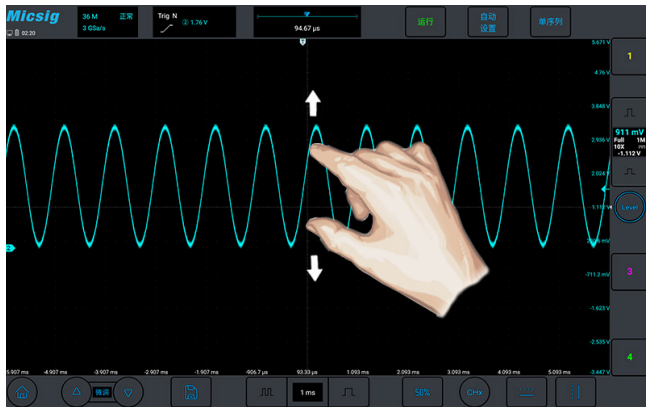

Smooth operation

14" full-touch integrated display, all operations can be completed by touch, more intuitive and efficient.

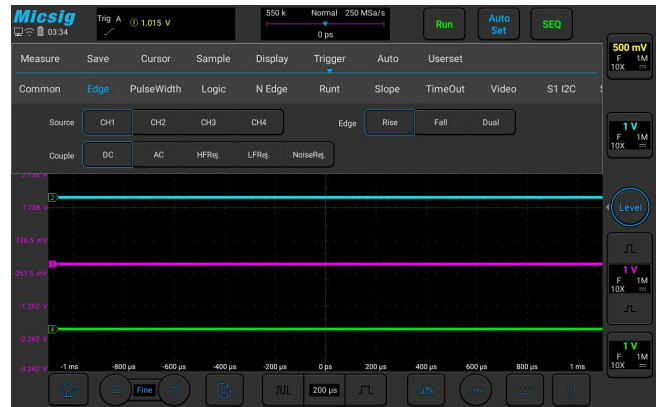

Most friendly UI

With accumulation of 10 years of UI design experience, the MDO series simplifies all user interfaces, engineers can quickly learn to use in 5 minutes.



Deep memory

Insufficient memory depth often leads to distortion when long time-base signals were expanded. With memory depth of up to 360Mpts, there is no reduction in performance even with two channels opened at the same time. The signals will still maintain excellent fidelity even at long period of time.

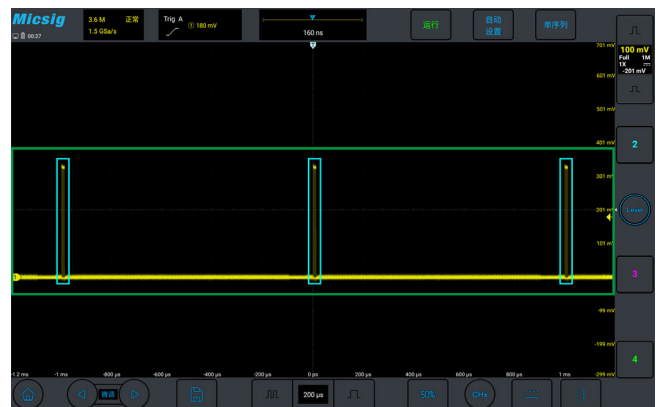

Segmented storage acquisition

Traditional Single acquisitions can only capture signals continuously, wasted storage depth when testing intermittent signals like laser pulses or serial buses, also difficult to trace back captured events. While the segmented storage acquisition can capture the target signal and allows to play back captured ones, effectively captures target signals multiple times over a long period of time.

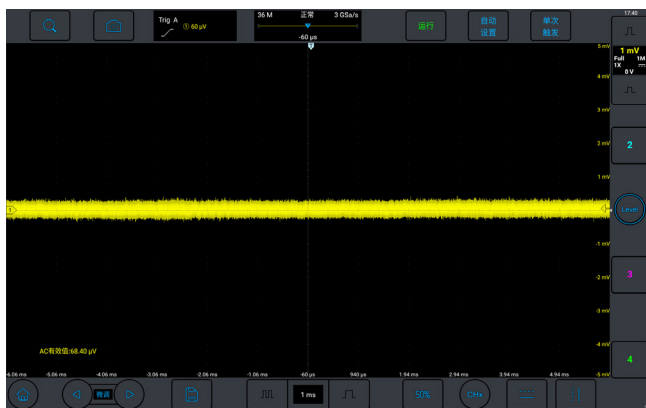

Low noise

Even at its full bandwidth of 500M, the noise floor of the MDO series still less than 90 μ Vrms, allow engineers accurately capture weak but important signals during daily debugging and signal analysis.

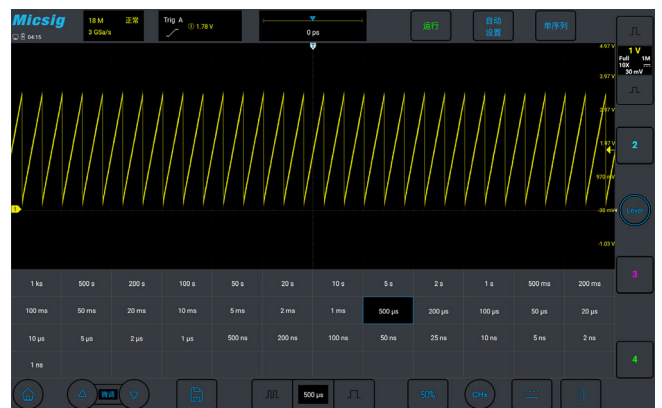

Faster time base adjustment

Traditional oscilloscopes need to step in a sequential manner when adjusting the time base. In addition to traditional sequential steps, the MDO series also has a time base matrix, allows user to select any time base in one click.

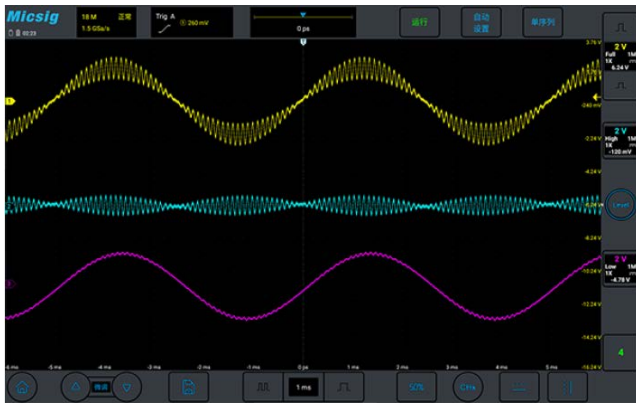

Full bandwidth High pass Low pass

Hardware digital filtering

Hardware digital filtering can effectively filter out interference and noise, improve signal accuracy. Digital filtering can selectively pass or block signal components within a specific frequency range.

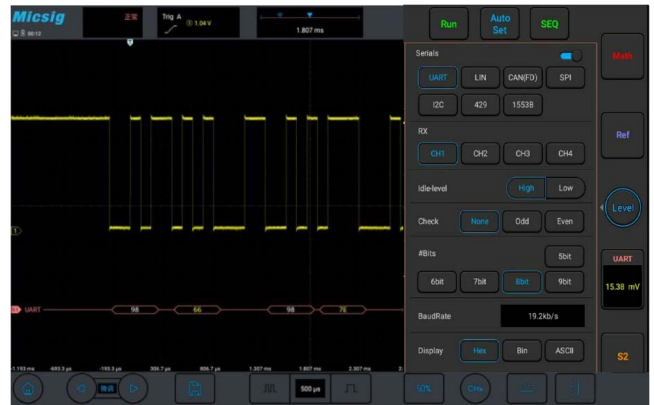

Serial bus decoding and analysis

The MDO series is standard with RS-232/422/485/ UART, CAN, LIN, CAN FD, SPI, I²C, ARINC-429, 1553B. With the TXT decoding text mode, the data can be transferred to CSV format.



Multiple Trigger Functions

The MDO series provide multiple triggers, including edge, pulse width, logic, Nth edge, runt, slope, bus decoding, etc. Whether you need to capture specific edge transitions, or observe duration and frequency of the target signal, it meets your requirement at ease.

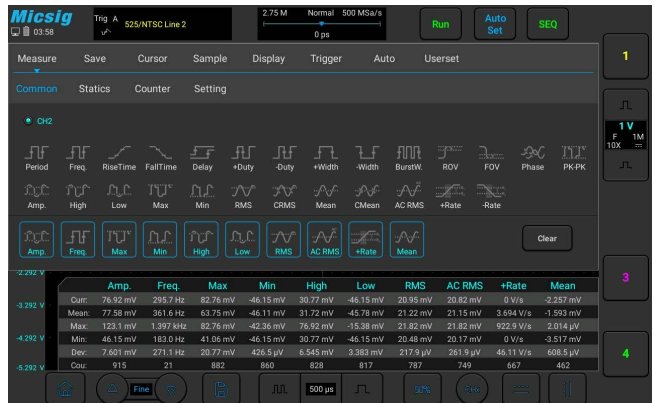

Statistics Measurement

Simultaneously calculate the average, maximum, minimum, and root mean square of 10 measurement items, with a max count of up to 10,000, every waveform data is accurately recorded, provide more accurate and comprehensive readings.

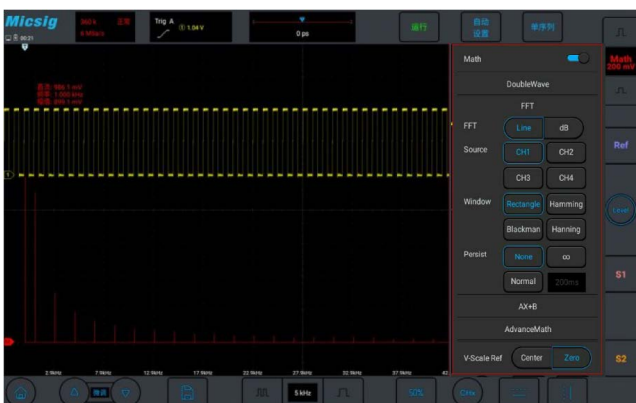

Advanced Math functions

Support various mathematical calculations: addition, subtraction, multiplication, division, integration, differentiation, etc. Support custom function formula for advanced signal analysis. Also support FFT (Fast Fourier Transform) for real-time spectral analysis of collected waveform signals.



Diverse file saving

Users can save waveforms and measurement results as binary (BIN) or CSV format for data analysis using Matlab or Excel. Also support saved as WAV format, open & analysis inside the oscilloscope. Additionally, user can save waveforms as images or record videos.

Product specifications

Vertical system	
Bandwidth filter	20MHz, High Pass / Low Pass
Coupling	DC, AC, GND
Input impedance and accuracy	1MΩ±1% 50Ω±1%
Vertical resolution	8 bits
Vertical divisions	10div
Vertical scale factor	1mV/div~10V/div (1MΩ) ; 1mV/div~1V/div (50Ω)
DC Gain accuracy	5mV/div ~10V/div: ≤ ±2.0%; ≤ 2mV/div: ≤ ±3.0%
Vertical offset range(1MΩ/50Ω)	±2.5V (@probe X1 , < 500mV/div) , ±125V (@probe X1, ≥ 500mV/div)
Noise floor	≤ 90μVrms (1mV/div, 1MΩ)
Max. input voltage	CAT I 300Vrms 400Vpk (1MΩ) , 5Vrms (50Ω)
Channel isolation	> 40dB (≤ 100MHz) , > 35dB (> 100MHz)
Vertical expansion datum	Screen center, channel zero point
Probe Attenuation Ratio	1mX~10kX, 1-2-5 sequence, support customization

Horizontal system	
Horizontal scale	1ns/div~1ks/div
Roll mode range	200ms/div~1ks/div
Time base accuracy	20ppm
Horizontal divisions	12div
Time base delay time range	-12 div ~ 12ks, resolution: 1 pixel

Trigger system	
Trigger mode	Auto, Normal, Single
Trigger level range (analog)	±5div from screen center, analog channel
Hold off range	200ns~10s
Trigger coupling and frequency (analog)	DC, AC(110Hz), low frequency (58kHz), high frequency (58kHz), noise (18MHz)
Trigger Types	Edge, Pulse Width, Logic, N Edge, Runt Pulse (Runt), Slope, Time Out, Video, Serial
Bus decoding	RS-232/422/485/UART, CAN, CAN FD, LIN, SPI, I ² C, ARINC429, 1553B

Sampling System	
Max. Real-time sampling rate	3G Sa/s (Either one of CH1 & CH2 is open, and either one of CH3 & CH4 is open); 1.5G Sa/s (Both CH1 and 2CH, or both CH3 and CH4 are open)
Memory depth (Max.)	360Mpts/36M/3.6M/360K/36K/3.6K/ Auto (Either one of CH1 & CH2 is open, and either one of CH3 & CH4); 180Mpts/18M/1.8M/180K/18K/1.8K/ Auto (Both CH1 and 2CH, or both CH3 and CH4 are open)
Peak sampling interval	single channel 333ps, dual channel 666ps
Average	2,4,8,16,32,64,128,256
Envelope times	2,4,8,16,32,64,128,256, ∞

Measurements	
Auto measurements	Period, frequency, rise time, fall time, delay, positive duty cycle, negative duty cycle, positive pulse width, negative pulse width, burst pulse width, positive overshoot, negative overshoot, phase, peak-to-peak, Amplitude, High, Low, Maximum, Minimum, RMS, C RMS, Average, C Average, AC RMS, Positive Slope, Negative Slope *C represents the first period, indicating a certain value in the first period of the waveform
Hardware frequency counter and resolution	Support each analog channel, 6bit, 2Hz~max. bandwidth, pk-pk > 0.8div
Cursor	Horizontal, Vertical, Cross
Cursor resolution	1 pixel
Math	
Dual waveform	+, -, *, /, Analog channel
FFT	Points: max. 360k; Source: Analog channel; Window: Rectangular, Hamming, Blackman, Hanning
AX+B	A: $\pm 1k$, Min. Resolution 1p or 4it B: $\pm 1k$, Resolution 1p or 5bit X: Analog channel
Advanced math	Advanced input, including +, -, *, /, <, >, \leq , \geq , ==, !=, &&, , (,) , !(, sqrt, abs, deg, rad, exp, diff, ln, sin, cos, tan, intg, lg, asin, acos, atan
Display	
Display	14" capacitive TFT touch screen, 1920*1200 resolution, 12*10 Divisions
Persistence	Auto, 10ms~10s, ∞
Time base mode	YT, XY, Roll, Zoom
Expand base	Center, trigger position
Waveform Display	Dot, line, adjustable brightness
Waveform Update Rate	230,000 wfms/s
Storage	
Storage media	Local , USB drive
ROM storage	32GB
Storage format	WAV, CSV, BIN
Quantity of stored waveforms	No limit
Stored waveform rename	Chinese, English
REF waveforms display	4
Quick screenshot	Support
Quantity of user setting	10
User setting rename	Support
Flash memory	Industry standard
Screenshot, video recording	Support

System	
Self-calibration	Support
Languages	English, Chinese, German, French, Czech, Korean, Spanish, Italian, etc
Operating System	Android
Built-in app	App Store, Browser, Oscilloscope, Calendar, Clock, Gallery, Calculator, User Guide, Electronic Tools, File Manager
Warranty	Three-year for mainframe. Probes and accessories are not covered. * Please refer to the data sheet of each probe and accessory for the respective warranty terms. (contact us for extended warranty)

Interfaces	
USB3.0	4, read and edit
USB Type-C	1, read and edit
LAN	1
4-pin aviation power socket	1
Probe calibration signal	1kHz, 2Vpk-pk
HDMI	HDMI 1.4
PC	Support
Android/iOS remote control APP	Support
SCPI	Support

Power supply	
Adapter input	100~240V AC, 50/60Hz
Power consumption	< 120W
Adapter output	24V DC, 5A
Power plug	Local

Environment	
Temperature	
Operating	0°C ~ 45°C
Non-operating	-40°C ~ 60°C
Humidity	
Operating	5% ~ 85%, 25°C
Non-operating	5% ~ 90%, 25°C
Altitude	
Operating	< 3000m
Non-operating	< 12000m

Physical Characteristics	
Dimensions	Main unit: 400*280*35.8mm
Net Weight	4.3kg

Standard Accessories

Model	Standard Accessories
MDO Series	Passive Probe *4
	MSP-BNC adapter *4
	Power adapter *1
	Power cord *1
	Calibration certificate*1
	Quick Guide *1
	User Instructions *1
	Packing list*1

Optional instruments

Optical-fiber Isolated Probe	
SigOFIT series	Bandwidth: up to 1GHz, Common mode voltage: 85kVpk, DC gain accuracy: 1%, CMRR: up to 180dB
High Voltage Differential Probe	
MDP series	Bandwidth: up to 500MHz; Differential voltage (DC+AC PK) Max.3000V; Accuracy: $\pm 2\%$
Current Probes	
HF AC/DC current probe CP series	Bandwidth: up to 100MHz, Range: 6A/30A, Accuracy: $\pm 1\%$
LF AC/DC current probe CP2100 series	Bandwidth: up to 2.5MHz, Range: 10A/100A
Rogowski AC current probe RCP series	Bandwidth: 10Hz - 30MHz, Range: 200mApk-600Apk, Accuracy: 1%
AC Current Probe ACP1000	Bandwidth: 10Hz -100KHz, Range: 0.1Apk-1000Apk
Handbag & Suitcase	
Micsig handbag	Black nylon , suitable for all Micsig tablet oscilloscopes
Micsig Suitcase	Anti-fall, anti-seismic, anti-pressure, dust-proof, moisture-proof

* Micsig reserves all the rights of interpretation at any time, it is subject to update without prior notice.