

## Product Datasheet - Technical Specifications



More information in our Web-Shop at ► [www.meilhaus.com](http://www.meilhaus.com) and in our download section.

### Your contact

**Technical and commercial sales, price information,  
quotations, demo/test equipment, consulting:**

Tel.: **+49 - 81 41 - 52 71-0**

FAX: **+49 - 81 41 - 52 71-129**

E-Mail: [sales@meilhaus.com](mailto:sales@meilhaus.com)

Downloads:

[www.meilhaus.com/en/infos/download.htm](http://www.meilhaus.com/en/infos/download.htm)

**Meilhaus Electronic GmbH** | Tel. **+49 - 81 41 - 52 71-0**  
Am Sonnenlicht 2 | Fax **+49 - 81 41 - 52 71-129**  
82239 Alling/Germany | E-Mail [sales@meilhaus.com](mailto:sales@meilhaus.com)

Mentioned company and product names may be registered trademarks of the respective companies. Prices in Euro plus VAT. Errors and omissions excepted.  
© Meilhaus Electronic.

[www.meilhaus.de](http://www.meilhaus.de)

## 8064 LAN to RELAY Interface

### DESCRIPTION

The Model 8064 is an Ethernet to Relay Interface that provides 16 form 'A' contacts or 16 relay drivers for switching signals or for driving external relays. The 8064's versatile commands let the user control the relays individually, step them as a single or multi-pole scanner, or step in any programmed sequence. The 8064 also includes eight isolated digital inputs that can be used to read external signals or contact closures. In control applications, these signals can be used to verify the response of the external system to the control outputs. The 8064 can also monitor the digital inputs and generate a Service Request when the signals change state.

### Relays and Driver Outputs

Models with relays contain 16 floating form 'A' (SPST) relays with both sides of each relay contact brought out to the rear panel connector. The connector pin assignments are arranged to minimize signal cross talk. The relay contacts in the Model 8064-11 are for switching low level signals up to 0.5 amperes. The relay contacts in the 8064-12 are rated for switching currents up to 1.0 amperes. The 8064-14 has relay driver outputs that sink 300 mA to activate external relays or solenoids. A Relay Enable output signal is provided to control external devices that need to wait while the 8064 initializes at power turn-on time. The 8064 relays and relay drivers are glitch free and do not generate false outputs at power turn-on.

The relays and drivers are on a plug-in relay PCB which simplifies relay maintenance and contact type changes.



**8064 Relay Interface**

### Versatile Ethernet Connections

The 8064 is a VXI-11.3 compliant instrument and fits in with today's test equipment applications that use a VISA library. This lets the 8064 be controlled by a very wide range of applications and programming languages such as LabVIEW, C and Visual Basic.

The VXI-11 specification provides an RPCL (Remote Procedure Call Library) that can be used by virtually any operating system to control your instrument. This makes it easy to control the 8064 from any Linux or Unix type operating system.

The 8064 also supports a "Raw Socket" connection which enables sending of SCPI commands to the instrument via low-level send/receive commands over the LAN connection using TCP/IP. Raw Socket does not support Service Requests or other VXI-11.3 functions.

Each open socket is monitored to see that it is being used to prevent socket exhaustion. Sockets unused for longer than their timeout period are automatically closed and made available for reuse.

### Ethernet controlled relays and isolated digital inputs

- Multiple configurations:
  - 16 low-level SPST relays
  - 16 hi-power SPST relays
  - 16 relay drivers*Choose the correct contact or driver for your application.*
- Multiple relay programming modes:
  - individual relays
  - multi-pole scanning*Flexible relay programming.*
- Isolated digital inputs accept contact closures, CMOS, TTL, 5- 32 V inputs.
 *Eliminates ground loops.*
- Ethernet interface is VXI-11.3 Compliant and supports Raw Socket connections.
 *Works with virtually any computer or test language.*
- Network settings configurable with a web browser or RPC.
 *Easy network configuration from any computer.*
- Includes ICS's VXI-11 keyboard program.
 *The easy way to test relay connections before writing a test program.*

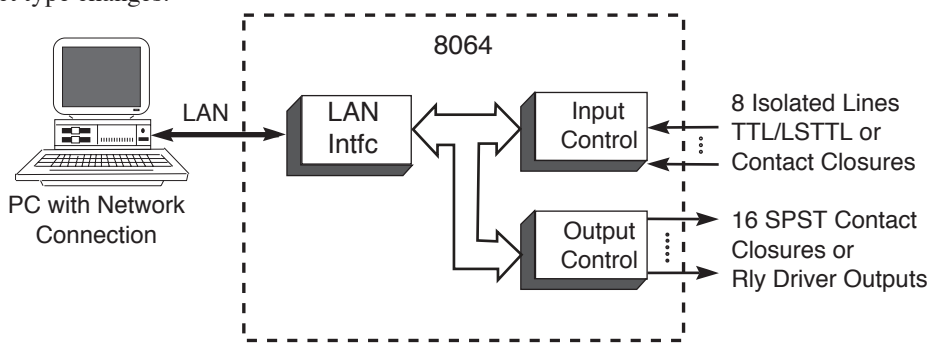

**Figure 1 8064 Block Diagram**

CE Approved

RoHS

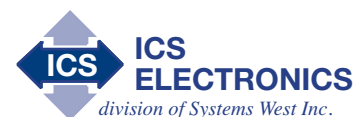

## 8064: Application

### Digital Inputs

The 8064 provides eight isolated digital inputs for TTL/CMOS signals, contact closures or levels up to 32 Vdc. Each input has a pullup resistor to a common line that can be connected to the 8064's internal 5 Vdc power or connected to an external voltage source for 500 volts of isolation.

### Data Transfer Methods

The 8064 has a single VXI-11 Interface personality or name *intr0*. *intr0* is used for communicating with the 8064, for configuration, to control the relays and to read the digital inputs.

### SCPI and Short Form Commands

The 8064 uses SCPI Commands and their short-form command equivalents to control the relays and read the digital inputs. SCPI commands are a tree and branch structure that start from the main command and work out to a value, action or query at the end of the branch. SCPI commands. They have the advantage of being easy to read and not cryptic. They are self-documenting and make program maintenance easier. An example of a SCPI command is one which sets a relay:

```
ROUTE:CLOSE 1      Activates relay #1
```

The equivalent Short Form command is:

```
C 1      Activates relay #1
```

### Controlling the Relays

The simplest way to control the 8064's relays (or relay driver outputs) is individually using the relay's CLOSE or OPEN commands. Unspecified relays remain in their current state. This satisfies most users who are controlling other device(s) or are switching signals. An example is:

```
ROUT:CLOS 5      'Closes relay number 5
```

Multiple relays can be opened and closed at the same time by entering the relay numbers in the list form. List are in parenthesis and are identified with the ASCII AT '@' character. Examples are:

```
ROUT:OPEN (@11:13) 'Opens relays 11 through 13
ROUT:CLOS (@1,3,4) 'Closes relays 1,3 and 4
```

### Scanning Options

For data acquisition applications, groups of the relays can be configured to operate as a single or multi-pole scanner. The relays are selected as a list with the ROUT:SCAN command. The INIT:IMMEDIATE command sets the relays to the first position and enables the scanner. The INIT:CONT command enables or disables the scanner. The scanner can be advanced with either the IEEE-488.1 GET command or with a 488.2 \*TRG command. The scanner operates as a break-before-make scanner. Unused relays can be controlled individually and used for other non-scanning applications. The scan relay list is stored in the 8064's Flash memory with the \*SAV 0 command. The maximum list size is 16 relays x 32 steps. Figure 2 shows the commands to setup a 2 pole, 3 position scanner.

TABLE 1 8064 SCPI COMMAND TREE

SCPI Commands	Short Form Cmds
SYSTEM	<b>System Setup and Query</b>
:ERRor?	
:VERSion?	
STATus	
:OPERation	
[:EVENT]?	
:CONDition?	
:ENABle	<numeric>
:ENABle?	
:QUESTionable	<b>Digital Inputs</b>
[:EVENT]?	E?
:CONDition?	D?
:ENABle	<numeric> M
:ENABle?	M?
:PTRansition	<numeric> P
:PTRansition?	P?
:NTRansition	<numeric> N
:NTRansition?	N?
ROUTE	<b>Relay Control</b>
:CLOSE	channel list C
:STATe?	Q?
:OPEN	channel list O
:ALL	A
:SCAN	S
:PULSe	channel list PL
:WIDTH	1-30000 [25] PW
INITiate	<b>Scan Control</b>
[:IMMEDIATE]	I
:CONTInuous	1(On) 0(Off) [0] N
CALibrate	Calibrate
:IDN	<string>
:DATE	mm/dd/yy
:DEFault	
:LOCK	1(On) 0(Off) [0]

ROUT:SCAN (@1,3,5), (@2,4,6)	'Defines scanner relays
INIT:IMM	'Closes initial pole (Relays 1 and 2)
INIT:IMM	'Sets scanner to initial position (No relays enabled)
*TRG or GET	'Turns relay 1 on
*TRG or GET	'Turns relay 1 off, relays 2 and 3 on
*TRG or GET	'Turns relay 2 off
*TRG or GET	'Turns relay 3 off, relay 4 on
*TRG or GET	'Turns relay 4 off (back to initial position)

Figure 2 Control Function Example

### Reading and Monitoring the Digital Inputs

The 8064's eight digital inputs are read by querying the Questionable register in the 8064's Status Reporting Structure. The Questionable Event register reports the bits that have changed since its

## 8064: Application

last reading. Positive and negative filter masks let the Questionable Event register capture bits that go high, go low or move in either direction with a > 1 kHz sample rate.

Enable bits allow the corresponding bits in the Questionable Event Register to be summarized in the 8064's Status Byte Register and to generate a *device\_intr\_srq* message (SRQ) over a reverse Interrupt Channel to alert the Application to the event. The user's Application program can query the 8064's Questionable Condition Register to determine the input signal states and/or the Event Register to learn which signal changed state.

### Easy Programmability

The 8064 can be easily controlled by several programming techniques and languages because it is a VXI-11.3 instrument. If you program with LabVIEW, National Instruments' VISA supports VXI-11.3 instruments like the 8064. NI's Measurement and Automation Explorer treats the 8064 as a TCP/IP compliant device.

Keysight's (Agilent's) VISA library supports VXI-11.3 instruments and the Keysight Connection Manager sees the 8064 as a TCP/IP instrument.

If you are a Visual Basic, VB.Net or C/C++ programmer, you can write your program to call Keysight's or National Instruments' VISA or Keysight's SICL library in the Windows environment.

If you use LINUX or any other flavor of UNIX like SunOS, IBM-AIX, HP-UX, or Apple's OS X, you can communicate with the 8064 through RPC over TCP/IP. RPC (or Remote Procedure Calls) provides an invisible communication medium for the developer. The VXI-11 specification provides an RPCL (Remote Procedure Call Library) that can be used by virtually any operating system to control the 8064. For more information about VXI-11 refer to ICS's VXI-11 Tutorial (Application Bulletin AB80-11) and RPC Programming (AB80-3) on [www.icselect.com](http://www.icselect.com).

If you program with Java then you can write a 8064 control program that can be easily moved to many different operating systems. The Java jGpibEnet project on SourceForge was developed using an ICS 8065 Controller.

Raw socket programmers can use any socket application such as Hyperterminal to send command strings to the 8064 and to read back query responses.

### Network Features

The TCP transportation layer and IP protocol used by the 8064 guarantees error free communication with the over the network or Internet as long as the connection is maintained. The 8064 has communication timeout feature to monitor the link status and Keepalive capability to maintain the communication link with the client application. When the 8064 discovers that the channel is no longer active, or when a channel is closed, the 8064 closes that channel and releases all resources that were used by the client. This unlocks any instruments links, destroys the links and returns all resources to the pool for the next user.

### Network Settings

There are two ways to configure the 8064's Network settings. The simplest way is to use a standard web browser and interact with the 8064's WebServer. The Welcome and configuration pages are shown on the right. LINUX and UNIX programmers can use ICS's defined RPC Commands to change and set the network settings.

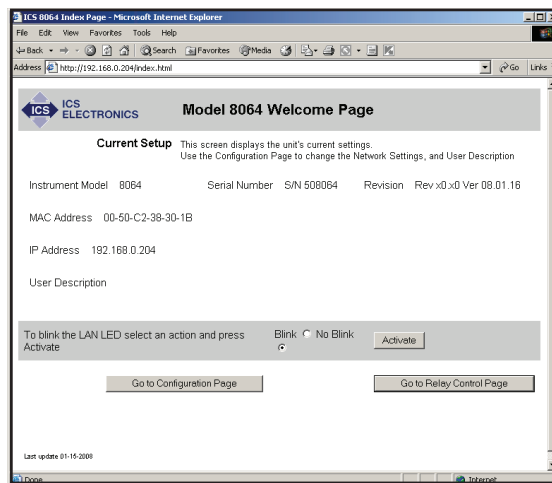

8064 Welcome Page

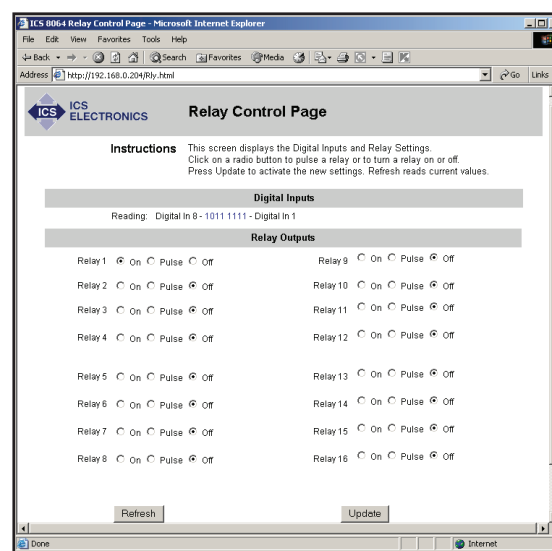

8064 Relay Control Page

### Browser Control of the Relays

The 8064's webserver includes a prototype Relay Control Page which allows a user to control the relays or relay driver outputs from any web browser. The Relay Control Page also displays the digital inputs. The Relay Control Page gives a user or maintenance people an easy way to test the 8064 or the relay connections with a standard web browser.

### Signal Connections

All 8064 relay and digital connections are brought out on a 50-pin blue-ribbon connector on the 8064's rear panel. A mating connector is included with each unit. The relay outputs are floating form 'A' (normally open) contacts. Relay driver signals are brought out on the NO contact pins. The 8064's relays and drivers are not enabled after a power turn-on until the user's saved configuration has been loaded into their driving latches. This prevents erroneous switching while the 8064 is performing its power-on selftest. A Relay Enable signal is provided to control external devices that may need to be held off.

## 8064: Application

### 8064 Terminal Board

The 8064 Terminal Board is a small board with screw terminals that plugs into the 8064's rear panel connector. It has terminals for the relay contacts, the digital inputs and for the miscellaneous signals. The 115750 Terminal Board includes the hardware to fasten it to the 8064.



**8064 Terminal Board**

### Rack Mounted Terminal Strip

A rack mounted Terminal Board is available for the 8064. The 114534-60 Terminal Strip mounts across the rear rails of an DIN/RETMA equipment rack and provides the user with lever actuated terminals for the 8064 signals. A 60 cm (24 inch) long flat-ribbon cable connects the Terminal Board to the 8064.

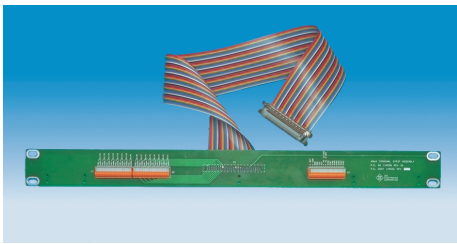

**Rack Mounted 8064 Terminal Strip**

### OEM Board Version

The 8064 is available as a board version for mounting inside a test chassis. Board versions are designed to be mounted against a plate or bracket and accept 12 to 24 volt power. See Figure 4. Optional Wiring Kits extend the LAN connection on the 8064 board to the rear panel. The Relay Contact - Digital IO connector is a right angle 50-pin connector with lock springs. A mating 50-pin connector is included with each OEM board. An 8 pin header on the OEM board allows easy extension of the 8064's LEDs to the user's front panel. Order part numbers 115631-11, 115631-12 or 115631-14.

### Firmware Customization

The 8064's firmware allows the user to store a custom IDN message and other setup parameters in the 8064's Flash memory. A lock function hides the setup variables from the end user and prevents accidental changes to the setup.

The user can also customize the HTML pages used in the 8064's web-server to display his company name and logo or to match his company's web image. The Relay Control page can be modified to show what the relays control by replacing the generic 'Relay *n*' names with a more descriptive name such as 'Heat Pump 1'. All of these changes effectively integrate the 8064 into the user's system and makes the 8064 appear as part of the company's product line.

**TABLE 2 8064 Signal-Pin Assignments**

Signal	Pin	Description
Relay 1 NO	1	Relay Contact or Driver 1 Output
Relay 1 Arm	26	
Relay 2 NO	2	Relay Contact or Driver 2 Output
Relay 2 Arm	27	
Relay 3 NO	3	Relay Contact or Driver 3 Output
Relay 3 Arm	28	
Relay 4 NO	4	Relay Contact or Driver 4 Output
Relay 4 Arm	29	
Relay 5 NO	5	Relay Contact or Driver 5 Output
Relay 5 Arm	30	
Relay 6 NO	6	Relay Contact or Driver 6 Output
Relay 6 Arm	31	
Relay 7 NO	7	Relay Contact or Driver 7 Output
Relay 7 Arm	32	
Relay 8 NO	8	Relay Contact or Driver 8 Output
Relay 8 Arm	33	
Relay 9 NO	9	Relay Contact or Driver 9 Output
Relay 9 Arm	34	
Relay 10 NO	10	Relay Contact or Driver 10 Output
Relay 10 Arm	35	
Relay 11 NO	11	Relay Contact or Driver 11 Output
Relay 11 Arm	36	
Relay 12 NO	12	Relay Contact or Driver 12 Output
Relay 12 Arm	37	
Relay 13 NO	13	Relay Contact or Driver 13 Output
Relay 13 Arm	38	
Relay 14 NO	14	Relay Contact or Driver 14 Output
Relay 14 Arm	39	
Relay 15 NO	15	Relay Contact or Driver 15 Output
Relay 15 Arm	40	
Relay 16 NO	16	Relay Contact or Driver 16 Output
Relay 16 Arm	41	
V Return	17	External Relay Ground Return
V Common	42	External Relay + Voltage Input
Logic Gnd	18	
Logic Gnd	43	
+ 5 Vdc	19	
+ 5 Vdc	44	
Shield Gnd	20	
Relay Enable	45	
V Pullup High	21	External 16-30 Vdc Input
V Pullup Low	46	External 5-20 Vdc Input
Digital In 8	22	
Digital In 7	47	
Digital In 6	23	
Digital In 5	48	
Digital In 4	24	
Digital In 3	49	
Digital In 2	25	
Digital In 1	50	

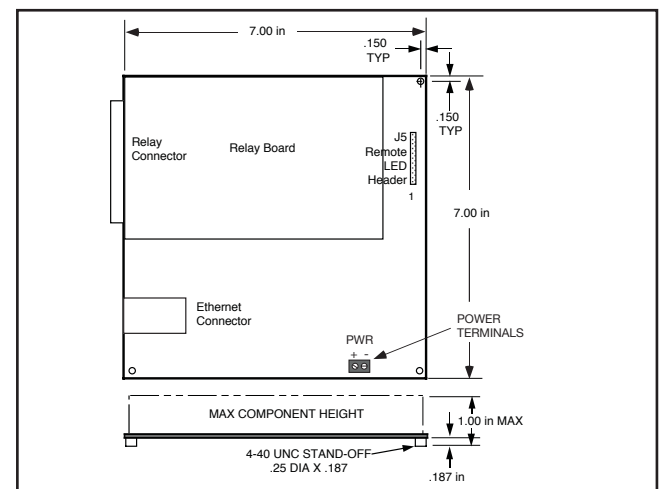

**Figure 4 8064 OEM Board Layout**

## 8064: ORDERING GUIDE

Select the 8064 version and then pick your accessory items.

Part Selection	Qty	Part Number
Standard 8064 Relay Interface Minibox. Includes a 50-pin mating connector and hood -		
with 16 form 'A' low level contacts	(1)	8064-11
with 16 form 'A' heavy duty contacts	(1)	8064-12
with 16 sink type relay drivers	(1)	8064-14
Select an extra mating digital I/O connector, 50-pin ribbon connector and hood	(1)	902002
Select an Open end, 50 conductor, 28 AWG wire cable assembly, 5 feet long	(1)	112829-01
or		
Select the 4864 Terminal Board	(1)	115750
or		
Select the 4864 I/O terminal Strip with 60 cm long flat-ribbon cable	(1)	114534-60 (Note 1)
8064 OEM Relay Interface Board. Includes a 50-pin mating connector and hood -		
with 16 form 'A' low level contacts	(1)	115631-11
with 16 form 'A' heavy duty contacts	(1)	115631-12
with 16 sink type relay drivers	(1)	115631-14
Select a Chassis Wiring Kit -		
with 1 foot long cable	(1)	115606
with 2 foot long cable	(1)	115607
Select an extra mating digital I/O connector, 50-pin ribbon connector and hood	(1)	902002
Select an Open end, 50 conductor, 28 AWG wire cable assembly, 5 feet long	(1)	112829-01
or		
Select the 4864 Terminal Board	(1)	115750
or		
Select the 4864 I/O terminal Strip with 60 cm long flat-ribbon cable	(1)	114534-60 (Note 1)

Notes: 1. The dash number is the cable length in cm.

### Wiring Kits

ICS's Wiring Kits provide a short 1 or 2 foot long Cat 5 cable and a shielded bulkhead connector of extending the 8064's Ethernet connector to the rear panel of the host chassis.

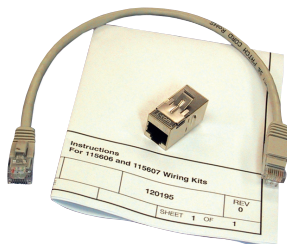

**115606 Wiring Kit**

### Rack Mounting Kits

The rack mounting kits are available for mounting one or two 8064s in a 1 'U' high space. Order P/N 114212 for mounting one unit, P/N 114213 for mounting two units.

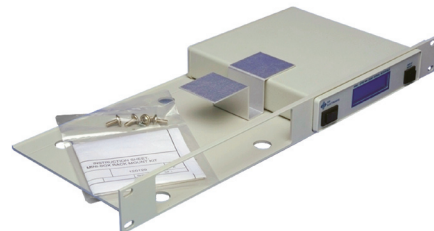

**114213 Dual Rack Mount Kit**

## 8064: Specifications

### Supported Standards

#### VXI-11 Capabilities

Fully VXI-11.3 compliant

VXI-11.3	Device Interface
Sockets	15 + 1 for UDP
Channel types	Data, Abort and Interrupt
Links	64
Interface Names	intr0 for general use intr1 for transparent data
VXI-11 Functions	device read, write, local, remote, clear, trigger, readstb, lock and unlock.

#### RPC Protocol

Conforms to ONC RPC Version 2, VXI-11

#### Ethernet Interface

Type	IEEE 802.3 compliant
Speeds	10BaseT (10 Mb/s) 100BaseT (100 Mb/s)
IP Address	Static or DHCP
Factory setting	192.168.0.254 static
Interface name	any [inst0]
Protocols	VXI-11, Raw Socket

#### WebServer Capabilities

Webserver and HTML Loader Utility provides the following capabilities:

File types	.html, .gif, .jpg, .png, .hgl and .xml
Number of files	32 maximum
File size	63 kbytes for all files 32 kbytes max. single file
File name size	27 characters

#### IEEE 488.2 Capabilities:

Runs all required 488.2 Common Commands, incorporates an extended IEEE-488.2 Status Reporting Structure and the Message Exchange Protocol.

#### SCPI Capabilities:

Incorporates the SCPI Command Tree shown in Table 1. Complies with SCPI version 1994.0.

#### LXI Information:

The 8064 generally follows the LXI 1.1 Specification for Class C instruments and may be used in systems with LXI instruments. The 8064's VXI-11.3 and IEEE-488.2 conformance exceeds LXI requirements.

#### Controls

Power	Front panel switch
LAN Rst	Rear panel push-button that resets the network settings

### Relay Contacts

All relay contacts are brought out to individual pins on the relay connector. Guard lines are provided on the PC board between adjacent relay contacts to minimize crosstalk.

Model No.	8064-11	8064-12
Usage	Lo level	Hi Power
No. of Relays	16	16
Contact form	Form A (SPST)	Form A (SPST)
Contact mat'l	Ruthenium	-
Contact ratings:		
(Restive load)	0.5 A	1.0 A
Switching V	200 Vdc	200 Vdc
Power	10 W	50 W
Breakdown V	300 Vac	300 Vac
Resistance	0.15 Ω	0.2 Ω

### Relay/Solenoid Driver Outputs

The -14 version has the relay driver outputs. Relay drivers are open collector type with an internal snubber diode. User supplies the positive relay power for the diodes.

Model No.	8064-14
Usage	External relays
No. of Drivers	16
Sink Current	300 mA max
Switching V	48 Vdc max

### Scanner-Sequence Memory

16 relays x 32 steps

### Digital Inputs

Eight isolated inputs that can be queried and/or monitored for selected bit changes. Detected changes are saved and can be used to generate a Service Request (SRQ).

Data lines	8
Input signals	TTL/CMOS or contact closure to ground
Input Levels	Low = 0±0.5 V @ 2 mA High=>2.4 V or open
Pullups	1.5 Kohm to +5 Vdc or to user furnished external voltage
External Voltage	5 to 32 Vdc
Isolation	500 Vdc to internal logic with external pullup voltage.
Monitoring	> 1k samples/sec

### Indicators

PWR	Indicates power on
LAN	Unit connected to an active LAN Blinks to identify the unit.
ACT	Transferring messages to/from the network
RDY	Unit has passed self test
TALK	Unit asked to send data
LSTN	Unit sent a command or data
SRQ	Device Service Request asserted
ERR	Blinks for a soft VXI-11 error and On for solid command errors

### Physical

#### Size, L x W x H

7.29 x 7.45 x 1.52 inches  
(185.2 x 189.2 x 38.6 mm)

**Weight** 1.6 lbs. (0.73 kg.) plus pwr adapter

**Construction** RoHS compliant, lead free

#### Connector and Headers

Digital I/O:	50-pin female, metal DC shell blue-ribbon connector with locking springs.
LEDs:	8-pin male header
Ethernet:	RJ-45

#### Temperature

Operation	-10° C to +55° C
Storage	-40° C to +70° C

#### Humidity

0-90% RH without condensation

#### Power

12 to 24 Vdc @ 7 VA + 50 mA/closed relay

#### Approvals

EEC Standards EN 61000-6-4:2001, EN 61000-6-2:2001, EN 55024:2003, and EN 55022:2003.

### Included Accessories

Instruction Manual  
Mating Connector  
LAN Crossover Cable.  
CD-ROM with VXI-11 Keyboard Controller program and Configuration Utility.  
UL/CSA/VDE approved AC power Adapters:  
US - 115±10% Vac, 60 Hz (std.)  
-E Europe - 230±10% Vac, 50/60 Hz  
-B UK - 230±10% Vac, 60 Hz  
-U Japan - 100±10% Vac, 50/60 Hz  
-A Australia/China - 230±10% Vac, 60 Hz

## ORDERING INFORMATION

	Part Number
Ethernet to Relay Interface with low level contacts	8064-11
Ethernet to Relay Interface with heavy duty contacts	8064-12
Ethernet to Relay Interface with relay drivers	8064-14
4864 Terminal Board	115750
4864 Rack Mount Terminal Strip with 60-cm long cable	114534-60
Wiring Kit with Shielded Bulkhead Adapter and 1 ft long Ethernet extension cable	115606
Wiring Kit with Shielded Bulkhead Adapter and 2 ft long Ethernet extension cable	115607