

## Product Datasheet - Technical Specifications



More information in our Web-Shop at ► [www.meilhaus.com](http://www.meilhaus.com)

### Your contact

Technical and commercial sales, price information,  
quotations, demo/test equipment, consulting:

Tel.: +49 - (0)81 41 - 52 71-0

E-Mail: [sales@meilhaus.com](mailto:sales@meilhaus.com)

**Meilhaus Electronic GmbH**  
Am Sonnenlicht 2  
82239 Alling/Germany

Tel. +49 - (0)81 41 - 52 71-0 E-  
Mail [sales@meilhaus.com](mailto:sales@meilhaus.com)

Mentioned company and product names may be registered trademarks of the respective companies. Errors and omissions excepted. © Meilhaus Electronic.

# Keysight Streamline Series USB Vector Network Analyzer P937XA 2-port, up to 26.5 GHz

Compact form. Zero compromise.



# Keysight Streamline Series: Exceptional Performance in a Small Package

Balance deadlines, productivity, budget and bench space with the Keysight P937xA, a member of Keysight's Streamline Series. You'll move confidently across every stage of your product's development lifecycle by leveraging accurate and repeatable measurements, automated code capability, and a consistent, intuitive user experience. With comprehensive Keysight services including calibration, education and consulting, these instruments enhance your solution to help you accelerate technology adoption and lower costs.

The P937xA series, Keysight's first compact vector network analyzer (VNA), is an affordable full two-port VNA which dramatically reduces your size of test. The compact VNA has wide frequency coverage with six frequency breaks, that operates from 300 kHz up to 26.5 GHz. The VNA is packaged in a compact chassis and controlled by an external computer with powerful data processing capabilities and functionalities. The firmware running on the PC has the same intuitive GUI as the other Keysight VNAs which allows you to reduce switching cost between models.



## Applications

- Manual test of passive components (e.g. antennas, filters, cables, connectors, adaptors)
- Wireless component manufacturing test
- Aerospace/defense manufacturing test
- Evaluation/design validation in classified environment

## Key performance

The Keysight compact VNA offers the good performance on key specifications such as dynamic range, measurement speed, trace noise and temperature stability. It utilizes the same measurement science with the trusted Keysight VNAs, you can have consistent measurement results.

- Measurement speed: 24 msec (201 points, full 2-port cal, 100 kHz IFBW)
- Dynamic range: > 114 dB at 9 GHz > 110 dB at 20 GHz (10 Hz IFBW)
- Trace noise: < 0.003 dBrms (1 kHz IFBW)
- Stability: 0.005 dB/degree C up to 4.5 GHz

## Key features

- Most compact VNA for easy sharing between test locations
- Wide choice of frequency ranges from 300 kHz up to 26.5 GHz
- Ability to extend the number of test ports (max 4-port)
- Frequency and software upgrades at any time
- Common GUI and measurement science within trusted Keysight VNAs
- Support of Electronic Calibration (ECal) Modules for easy and quick calibration

# Table of Contents

Definitions.....	4
System Specifications .....	5
Table 1. Frequency Information.....	5
Table 2. Noise Floor and Dynamic Range.....	5
Corrected Performance.....	6
Table 3. With N4691B Electronic Calibration Module .....	6
Table 4. With 85052D Standard Mechanical 3.5 mm Calibration kit.....	7
Uncorrected System Performance .....	8
Table 5. Uncorrected Error Terms - Specification .....	8
Test Port Output.....	8
Table 6. Maximum Output Port Power.....	8
Table 7. Nominal Power (preset power level) .....	8
Table 8. Power Range .....	9
Table 9. Power Level Accuracy.....	9
Table 10. Source Harmonics.....	9
Table 11. Non-harmonic Spurs.....	10
Table 12. Phase Noise.....	10
Test Port Input.....	10
Table 13. Test Port Input Damage Level.....	10
Table 14. Receiver Compression Level for 0.1 dB Compression (typical).....	10
Table 15. Receiver Compression Versus Test Port Power Level (specified) .....	11
Table 16. Receiver Level Accuracy.....	11
Table 17. Noise Floor (10 Hz IF bandwidth) .....	12
Table 18. Magnitude Trace Noise (1 kHz IF bandwidth, -5 dBm power) .....	13
Table 19. Magnitude Trace Noise (characteristic performance, +6 dBm power).....	13
Table 20. Magnitude Trace Noise (typical performance, +6 dBm power) .....	13
Table 21. Phase Trace Noise (1 kHz IF bandwidth, -5 dBm power) .....	13
Table 22. Phase Trace Noise (characteristic performance, +6 dBm power) .....	14
Table 23. Phase Trace Noise (typical performance, +6 dBm power) .....	14
Table 24. Temperature Stability (typical).....	14
Dynamic Accuracy .....	15
Table 25. Dynamic Accuracy 4 GHz to 16.5 GHz.....	15
Table 26. System Requirements.....	17
Table 27. Environment and Physical Specifications.....	17
Table 28. Regulatory and Safety Compliance.....	18
Table 29. Physical Size and Weight .....	18
Table 30. Electrical Power .....	18
Table 31. Front Panel Information .....	19
Table 32. Rear Panel Information.....	20
Table 33. Measurement Speed (milliseconds).....	20
Table 34. Measurement Capabilities .....	22
Table 35. Miscellaneous Information .....	23
Table 36. Software.....	23
Literature Information.....	24
Web Resources .....	24

# Definitions

## Specification (spec.)

Warranted performance. Specifications include guardbands to account for the expected statistical performance distribution, measurement uncertainties, and changes in performance due to environmental conditions. All specifications and characteristics apply over a  $25\text{ }^{\circ}\text{C} \pm 5\text{ }^{\circ}\text{C}$  range ambient and instrument temperature between  $33\text{ }^{\circ}\text{C}$  to  $46\text{ }^{\circ}\text{C}$  (unless otherwise stated). The following conditions must be met:

- Instrument has been turned on for 60 minutes with USB VNA application running.
- Instrument is within its calibration cycle.
- Instrument remains at a stable surrounding environment temperature (between  $-10\text{ }^{\circ}\text{C}$  to  $55\text{ }^{\circ}\text{C}$ ) for 60 minutes prior to turn-on.

## Characteristic (char.)

A performance parameter that the product is expected to meet before it leaves the factory, but that is not verified in the field and is not covered by the product warranty. A characteristic includes the same guardbands as a specification.

## Typical (typ.)

Expected performance of an average unit at a stable temperature between  $25\text{ }^{\circ}\text{C} \pm 5\text{ }^{\circ}\text{C}$  for 60 minutes prior to turn-on and during operation; does not include guardbands. It is not covered by the product warranty. The instrument must be within its calibration cycle.

## Nominal (nom.)

A general, descriptive term or design parameter. It is not tested, and not covered by the product warranty.

## Calibration

The process of measuring known standards to characterize an instrument's systematic (repeatable) errors.

## Corrected (residual)

Indicates performance after error correction (calibration). It is determined by the quality of calibration standards and how well "known" they are, plus system repeatability, stability, and noise.

## Uncorrected (raw)

Indicates instrument performance without error correction. The uncorrected performance affects the stability of a calibration

## Temperatures referred to in this document are defined as follows:

- Full temperature range = individual instrument temperature of  $10\text{ }^{\circ}\text{C}$  to  $70\text{ }^{\circ}\text{C}$ , as reported by the instrument, and environment temperature of  $0\text{ }^{\circ}\text{C}$  to  $55\text{ }^{\circ}\text{C}$ .
- Controlled temperature range = individual instrument temperature of  $33\text{ }^{\circ}\text{C}$  to  $46\text{ }^{\circ}\text{C}$ , as reported by the instrument, and environment temperature of  $20\text{ }^{\circ}\text{C}$  to  $30\text{ }^{\circ}\text{C}$ .

## Frequency Break Points

For all tables in this data sheet, the specified performance at the exact frequency of a break is the degraded value of the two specifications at that frequency, unless otherwise indicated.

## Block Diagram

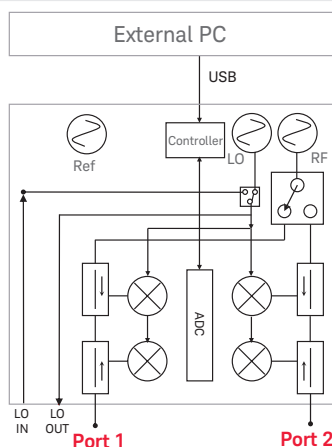

Figure 1. P937XA USB Vector Network Analyzer block diagram

# System Specifications

Table 1. Frequency information

Frequency Range		
Model number	Frequency range	
P9370A	300 kHz to 4.5 GHz	
P9371A	300 kHz to 6.5 GHz	
P9372A	300 kHz to 9 GHz	
P9373A	300 kHz to 14 GHz	
P9374A	300 kHz to 20 GHz	
P9375A	300 kHz to 26.5 GHz	
Frequency Resolution		
Frequency range	Specification	
300 kHz to 2.5 GHz	1 Hz	
> 2.5 to 5 GHz	2 Hz	
> 5 to 10 GHz	3 Hz	
> 10 to 20 GHz	6 Hz	
> 20 GHz	12 Hz	
Frequency reference	Specification	Typical
Accuracy	± 1 ppm	
Aging rate		< 3.5 ppm/year
Temperature stability		± 1 ppm over 0 to 55 °C
System impedance		
	50 Ω (nominal)	75 Ω with appropriate adapter and calibration kit

Table 2. Noise floor and dynamic range

Frequency Range	Noise Floor <sup>1</sup> (dBm) (specification)	Dynamic Range <sup>2</sup> (dB) (specification)	Dynamic Range <sup>3</sup> (dB) (typical)	Effective Dynamic Range <sup>4</sup> (dB) (characteristic)
300 kHz to < 10 MHz	–	–	111	97
10 to < 250 MHz	–98	98	110	95
250 MHz to 1 GHz	–108	115	122	114
> 1 to 4.5 GHz	–108	115	122	115
> 4.5 to 6.5 GHz	–108	115	122	115
> 6.5 to 9 GHz	–108	114	121	114
> 9 to 14 GHz	–108	114	120	110
> 14 to 18 GHz	–108	112	119	100
> 18 to 20 GHz	–108	110	118	98
> 20 to 24 GHz	–98	95	104	82
> 24 to 26.5 GHz	–	–	95	65

1. Noise floor in a 10 Hz IF bandwidth

2. System dynamic range = source maximum output power minus receiver noise floor at 10 Hz IF bandwidth. Does not include single module crosstalk effects.

3. System dynamic range = source maximum output power minus receiver noise floor at 10 Hz IF bandwidth. Does not include single module crosstalk effects.

4. Effective dynamic range is when the crosstalk is greater than the noise floor, and thus crosstalk limits the dynamic range. Crosstalk only limits the dynamic range for IF bandwidths < 1 kHz.

## Custom uncertainty calculator

This document provides technical specifications for the corrected performance of the P937XA VNA using either the N4691B Electronic Calibration Module, or the 85052D Standard Mechanical Calibration Kit. To determine transmission and reflection uncertainty curves with other calibration kits, please download our free Uncertainty Calculator from [http://www.keysight.com/find/na\\_calculator](http://www.keysight.com/find/na_calculator) to generate the curves for your specific calibration kit.

## Corrected performance

Table 3. With N4691B electronic calibration module<sup>1</sup>

Corrected error terms (dB) - 300 kHz to 24 GHz

Frequency	Directivity	Source Match	Load Match	Transmission Tracking		Reflection Tracking	
				Mag	Phase °	Mag	Phase °
300 kHz to < 2 MHz	31	29	29	±0.21	±1.4	±0.12	±0.74
2 MHz to 1 GHz	41	36	41	±0.021	±0.14	±0.061	±0.40
> 1 to 2 GHz	52	47	52	±0.0066	±0.044	±0.020	±0.14
> 2 to 4.5 GHz	48	45	48	±0.015	±0.095	±0.031	±0.20
> 4.5 to 6.5 GHz	48	45	48	±0.020	±0.14	±0.031	±0.20
> 6.5 to 9 GHz	48	45	45	±0.033	±0.22	±0.031	±0.20
> 9 to 14 GHz	46	42	43	±0.053	±0.35	±0.041	±0.27
> 14 to 20 GHz	46	42	42	±0.067	±0.44	±0.041	±0.27
> 20 to 24 GHz	44	40	40	±0.11	±0.69	±0.051	±0.34

## Transmission Uncertainty (magnitude and phase)

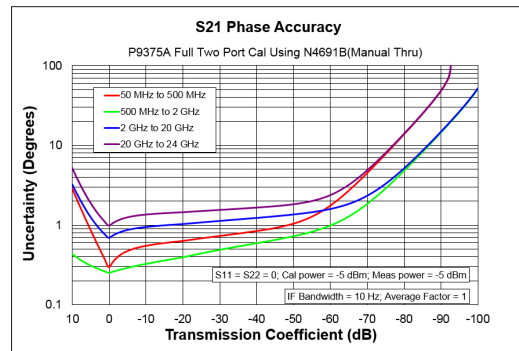
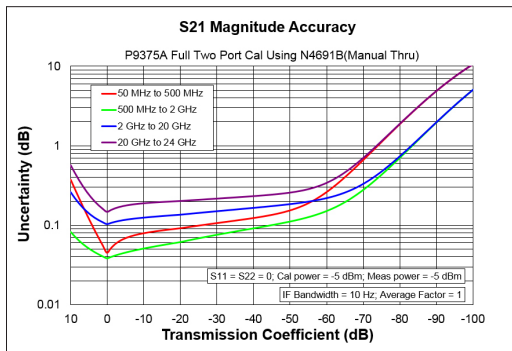

## Reflection Uncertainty (magnitude and phase)

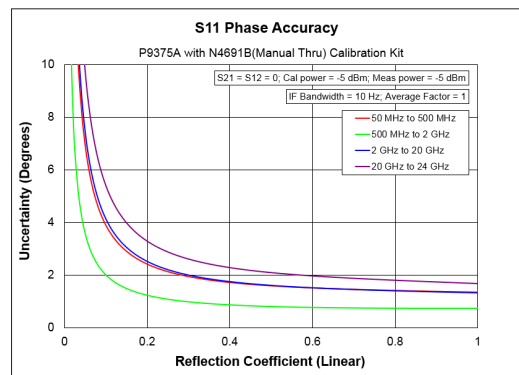
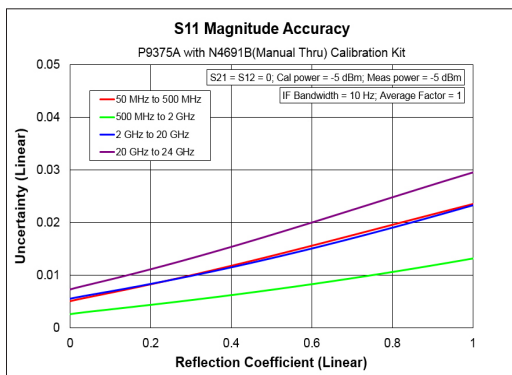

1. Measured with 10 Hz IF bandwidth, no averaging applied to data, environmental temperature = 23 °C (± 3 °C) with < 1 °C deviation from calibration temperature, isolation calibration performed.

Table 4. With 85052D standard mechanical 3.5 mm calibration kit<sup>1</sup>

Corrected error terms (dB) – 300 kHz to 24 GHz

Frequency	Directivity	Source Match	Load Match	Transmission Tracking		Reflection Tracking	
				Mag	Phase °	Mag	Phase °
300 kHz to < 2 MHz	42	37	42	± 0.068	± 0.450	± 0.003	± 0.020
2 MHz to 1 GHz	42	37	42	± 0.019	± 0.123	± 0.003	± 0.020
> 1 to 2 GHz	42	37	42	± 0.021	± 0.136	± 0.003	± 0.020
> 2 to 4.5 GHz	38	31	38	± 0.055	± 0.361	± 0.004	± 0.027
> 4.5 to 6.5 GHz	38	31	38	± 0.089	± 0.584	± 0.004	± 0.027
> 6.5 to 9 GHz	36	28	36	± 0.155	± 1.023	± 0.008	± 0.052
> 9 to 14 GHz	36	28	36	± 0.195	± 1.286	± 0.008	± 0.052
> 14 to 20 GHz	36	28	36	± 0.233	± 1.536	± 0.008	± 0.052
> 20 to 24 GHz	30	25	30	± 0.442	± 2.915	± 0.011	± 0.072

**Transmission Uncertainty (magnitude and phase)**

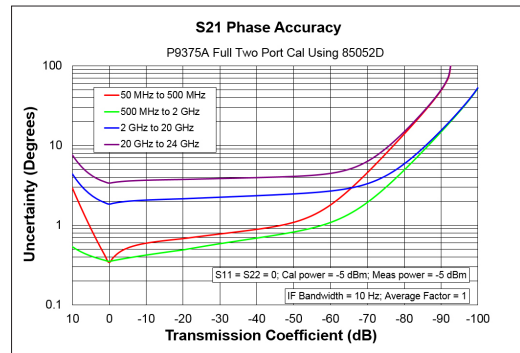
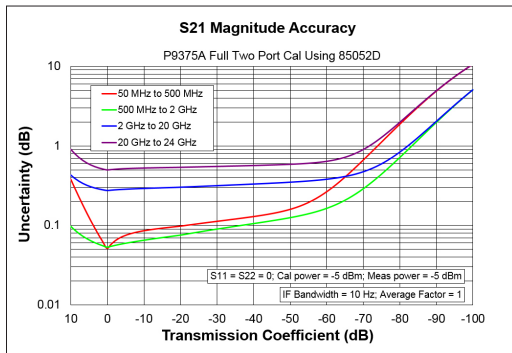

**Reflection Uncertainty (magnitude and phase)**

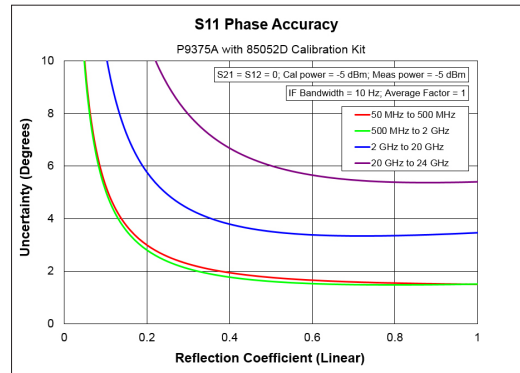
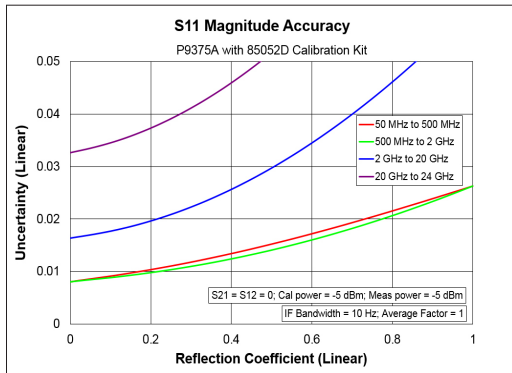

1. Measured with 10 Hz IF bandwidth, no averaging applied to data, environmental temperature = 23 °C (± 3 °C) with < 1 °C deviation from calibration temperature, isolation calibration performed.



## Uncorrected System Performance

Specifications apply to following conditions:

- Over environmental temperature of 25 °C ±5 °C,
- Cable loss not included in transmission tracking.
- Cross-talk measurement conditions: normalized to a thru, measured with shorts on all ports, 10 Hz IF bandwidth, averaging factor of 8, alternate mode, source power set to the specified maximum power.

Table 5. Uncorrected error terms - specification

Frequency	Directivity (specified)	Source Match (specified)	Load Match (specified)	Transmission Tracking (typical)	Reflection Tracking (typical)	Cross-talk (typical)
300 kHz to < 2 MHz	7	9	9	± 2	± 2	97
2 MHz to 1 GHz	20	19	21	± 2	± 2	95
> 1 to 2 GHz	20	20	19	± 2	± 2	123
> 2 to 4.5 GHz	18	20	13	± 2	± 2	121
> 4.5 to 6.5 GHz	15	15	11	± 2	± 2	121
> 6.5 to 9 GHz	10	11	8	± 2	± 2	119
> 9 to 14 GHz	9	9	7	± 2	± 2	110
> 14 to 20 GHz	4	6	6	± 2	± 2	98
> 20 to 24 GHz	3	5	4	± 2.5	± 2.5	82

## Test Port Output

Table 6. Maximum output port power

Frequency Range	Specification	Typical
300 kHz to < 10 MHz	–	+3 dBm
10 to < 250 MHz	0 dBm	+3 dBm
250 MHz to 4.5 GHz	+7 dBm	+10 dBm
>4.5 GHz to 6.5 GHz	+7 dBm	+10 dBm
> 6.5 to 9 GHz	+6 dBm	+9 dBm
> 9 to 14 GHz	+6 dBm	+8 dBm
> 14 to 18 GHz	+4 dBm	+7 dBm
> 18 to 20 GHz	+2 dBm	+6 dBm
> 20 to 24 GHz	-3 dBm	+1 dBm
> 24 to 26.5 GHz	–	-5 dBm

Table 7. Nominal power (preset power level)

Model	Specification
All models	-5 dBm

Table 8. Power range

Frequency Range	Specification	Typical
300 kHz to < 10 MHz	–	+3 dBm to –40 dBm
10 to < 250 MHz	0 dBm to –40 dBm	
250 MHz to 4.5 GHz	+7 dBm to –40 dBm	
> 4.5 GHz to 6.5 GHz	+7 dBm to –40 dBm	
> 6.5 to 9 GHz	+6 dBm to –40 dBm	
> 9 to 14 GHz	+6 dBm to –40 dBm	
> 14 to 18 GHz	+4 dBm to –40 dBm	
> 18 to 20 GHz	+2 dBm to –40 dBm	
> 20 to 24 GHz	–3 dBm to –40 dBm	
> 24 to 26.5 GHz	–	–5 to –40 dBm

Table 9. Power level accuracy

Frequency range	Power Level Range			
	Specification		Typical	
	–40 dBm ≤ P < –30 dBm	–30 dBm ≤ P < max port spec power	–40 dBm ≤ P < –30 dBm	–30 dBm ≤ P < max port spec power
300 kHz to < 2 MHz	–	–	± 1.3	± 1.0
2 to < 10 MHz	–	–	± 2.5	± 2.2
10 to < 250 MHz	± 4.5	± 2.5	± 1.0	± 0.7
250 MHz to 1 GHz	± 1.5	± 1.5	± 0.3	± 0.4
> 1 to 6.5 GHz	± 1.5	± 1.5	± 0.4	± 0.3
> 6.5 to 20 GHz	± 1.5	± 1.5	± 0.5	± 0.5
> 20 to 24 GHz	± 3.0	± 3.0	± 0.8	± 0.8
> 24 to 26.5 GHz	–	–	± 1.8	± 1.8

Programmable power resolution 0.01 dB typical

Table 10. Source harmonics<sup>1</sup>

Frequency Range	Specification	Typical
300 kHz to < 100 MHz	–	–6 dBc
100 MHz to 2 GHz	–	–6 dBc
2 to 4.5 GHz	–	–10 dBc
> 4.5 to 6.5 GHz	–	–11 dBc
> 6.5 to 14 GHz	–	–14 dBc
> 14 to 20 GHz	–	–8 dBc
> 20 to 26.5 GHz	–	–5 dBc

1. At maximum specified power, includes sub-harmonics.

Table 11. Non-harmonic spurs<sup>1</sup>

Frequency Range	Specification	Typical
300 kHz to < 10 MHz	–	–44 dBc
10 MHz to 10 GHz	–	–36 dBc
> 10 to 20 GHz	–	–30 dBc
> 20 to 26.5 GHz	–	–24 dBc

Table 12. Phase noise<sup>2</sup>

Frequency Range	Specification	Typical
300 kHz to < 2 MHz	–	–100 dBc/Hz
2 MHz to 2.5 GHz	–	–90 dBc/Hz
> 2.5 to 5 GHz	–	–84 dBc/Hz
> 5 to 10 GHz	–	–78 dBc/Hz
> 10 to 20 GHz	–	–72 dBc/Hz
> 20 to 26.5 GHz	–	–66 dBc/Hz

1. At nominal (preset) power of –5 dBm.

2. Phase noise in dBc/Hz, for output ports 1 or 2; typical values for 1 kHz, 10 kHz, and 100 kHz offsets.

## Test Port Input

Table 13. Test port input damage level

Frequency Range	Specification
300 kHz to 26.5 GHz	> +20 dBm, > ±35 VDC, > 1000V ESD

Table 14. Receiver compression level for 0.1 dB compression (typical)

Frequency Range	Specification	Typical
300 kHz to < 10 MHz	–	> +7 dBm
10 to < 250 MHz	–	> +8 dBm
250 MHz to 1 GHz	–	> +12 dBm
> 1 to 4.5 GHz	–	> +10 dBm
> 4.5 to 6.5 GHz	–	> +8 dBm
> 6.5 to 9 GHz	–	> +8 dBm
> 9 to 14 GHz	–	> +6 dBm
> 14 to 18 GHz	–	> +5 dBm
> 18 to 20 GHz	–	> +10 dBm
> 20 to 24 GHz	–	> +8 dBm
> 24 to 26.5 GHz	–	> +4 dBm

Table 15. Receiver compression versus test port power level (specified)

Frequency	Test Port Power Level (dBm)	Magnitude (dB)	Phase (degrees)
10 MHz to 250 MHz	0	.15	1.1
> 250 MHz to 1 GHz	7	.12	.9
> 1 to 2 GHz	7	.12	.6
> 2 to 4.5 GHz	7	.12	.7
> 4.5 to 6.5 GHz	7	.12	.9
> 6.5 to 9 GHz	6	.12	1.0
> 9 to 14 GHz	6	.16	1.3
> 14 to 18 GHz	4	.16	1.5
> 18 to 20 GHz	2	.13	1.6
> 20 to 24 GHz	-3	.11	1.0

Table 16. Receiver level accuracy

Frequency Range	Accuracy at -5 dBm input power level
300 kHz to 10 MHz	–
10 MHz to 26.5 GHz	± 0.5 dB <sup>1</sup>

1. Factory or service calibration required. Calibration can be refreshed any time using service routine. Accuracy across N-ports can be achieved with a multi-port cal.

Table 17. Noise floor (10 Hz IF bandwidth)

Frequency Range	Specification	Typical
300 kHz to < 10 MHz	–	-108 dBm
10 to < 250 MHz	-98 dBm	-107 dBm
250 MHz to 1 GHz	-108 dBm	-112 dBm
> 1 to 4.5 GHz	-108 dBm	-112 dBm
> 4.5 to 6.5 GHz	-108 dBm	-112 dBm
> 6.5 to 9 GHz	-108 dBm	-112 dBm
> 9 to 14 GHz	-108 dBm	-112 dBm
> 14 to 18 GHz	-108 dBm	-112 dBm
> 18 to 20 GHz	-108 dBm	-112 dBm
> 20 to 24 GHz	-98 dBm	-103 dBm
> 24 to 26.5 GHz	–	-100 dBm

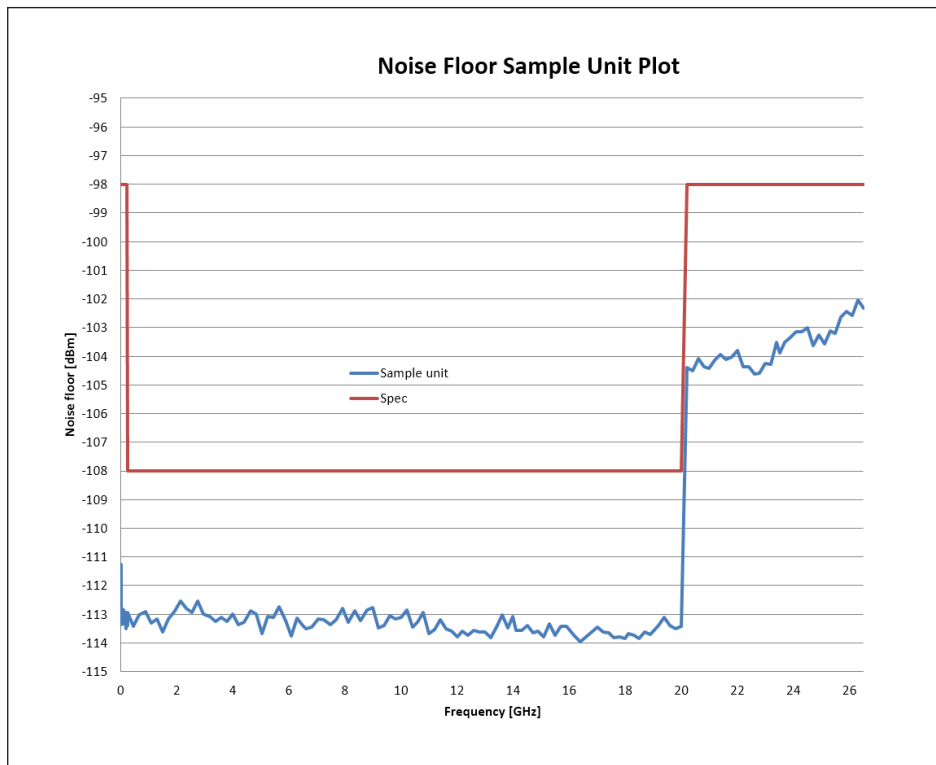

Figure 2. Noise floor specification lines and typical measured values.

Table 18. Magnitude trace noise (1 kHz IF bandwidth, -5 dBm power)

Frequency Range	Specification	Typical
300 kHz to < 10 MHz	–	0.0020 dB rms
10 to < 250 MHz	0.003 dB rms	0.0010 dB rms
250 MHz to 1 GHz	0.003 dB rms	0.0010 dB rms
> 1 to 4.5 GHz	0.003 dB rms	0.0010 dB rms
> 4.5 to 6.5 GHz	0.003 dB rms	0.0010 dB rms
> 6.5 to 9 GHz	0.003 dB rms	0.0010 dB rms
> 9 to 14 GHz	0.003 dB rms	0.0010 dB rms
> 14 to 20 GHz	0.003 dB rms	0.0010 dB rms
> 20 to 24 GHz	0.006 dB rms	0.0015 dB rms
> 24 to 26.5 GHz	–	0.0020 dB rms

Table 19. Magnitude trace noise (characteristic performance, +6 dBm power)

Frequency Range	10 kHz IF bandwidth	100 kHz IF bandwidth	600 kHz IF bandwidth
250 MHz to 10 GHz	0.0020 dB rms	0.0055 dB rms	0.0120 dB rms
> 10 to 14 GHz	0.0030 dB rms	0.0075 dB rms	0.0160 dB rms

Table 20. Magnitude trace noise (typical performance, +6 dBm power)

Frequency Range	10 kHz IF bandwidth	100 kHz IF bandwidth	600 kHz IF bandwidth
250 MHz to 10 GHz	0.001 dB rms	0.003 dB rms	0.007 dB rms
> 10 to 14 GHz	0.002 dB rms	0.004 dB rms	0.008 dB rms

Table 21. Phase trace noise (1 kHz IF bandwidth, -5 dBm power)

Frequency Range	Specification	Typical
300 kHz to < 10 MHz	–	0.020 deg rms
10 to < 250 MHz	0.030 deg rms	0.010 deg rms
250 MHz to 1 GHz	0.030 deg rms	0.010 deg rms
> 1 to 4.5 GHz	0.030 deg rms	0.010 deg rms
> 4.5 to 6.5 GHz	0.030 deg rms	0.010 deg rms
> 6.5 to 9 GHz	0.030 deg rms	0.010 deg rms
> 9 to 14 GHz	0.030 deg rms	0.010 deg rms
> 14 to 20 GHz	0.030 deg rms	0.010 deg rms
> 20 to 24 GHz	0.060 deg rms	0.015 deg rms
> 24 to 26.5 GHz	–	0.020 deg rms

Table 22. Phase trace noise (characteristic performance, +6 dBm power)

Frequency Range	10 kHz IF bandwidth	100 kHz IF bandwidth	600 kHz IF bandwidth
250 MHz to 8.5 GHz	0.010 deg rms	0.025 deg rms	0.060 deg rms
> 8.5 to 14 GHz	0.020 deg rms	0.055 deg rms	0.120 deg rms

Table 23. Phase trace noise (typical performance, +6 dBm power)

Frequency Range	10 kHz IF bandwidth	100 kHz IF bandwidth	600 kHz IF bandwidth
250 MHz to 8.5 GHz	0.006 deg rms	0.014 deg rms	0.033 deg rms
> 8.5 to 14 GHz	0.010 deg rms	0.030 deg rms	0.060 deg rms

Table 24. Temperature stability (typical)

Frequency Range	Magnitude Stability	Phase Stability
300 kHz to < 10 MHz	± 0.005 dB/°C	± 0.20 Degree/°C
10 MHz to 4.5 GHz	± 0.005 dB/°C	± 0.10 Degree/°C
> 4.5 to 6.5 GHz	± 0.010 dB/°C	± 0.15 Degree/°C
> 6.5 to 9 GHz	± 0.015 dB/°C	± 0.20 Degree/°C
> 9 to 14 GHz	± 0.015 dB/°C	± 0.40 Degree/°C
> 14 to 20 GHz	± 0.015 dB/°C	± 0.50 Degree/°C
> 20 to 26.5 GHz	± 0.020 dB/°C	± 0.60 Degree/°C

# Dynamic Accuracy

Table 25. Dynamic accuracy 4 GHz to 26.5 GHz

Accuracy of the test port input power relative to the reference input power level. Although labeled 'P9375A', these graphs apply to all models.

## Dynamic Accuracy, 4 GHz (magnitude and phase)

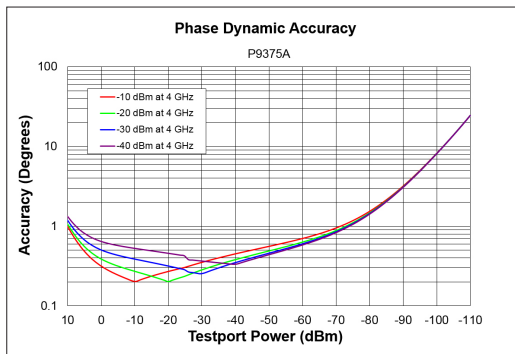
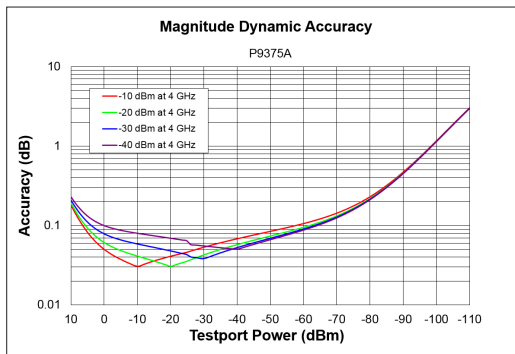

## Dynamic Accuracy, 6.5 GHz (magnitude and phase)

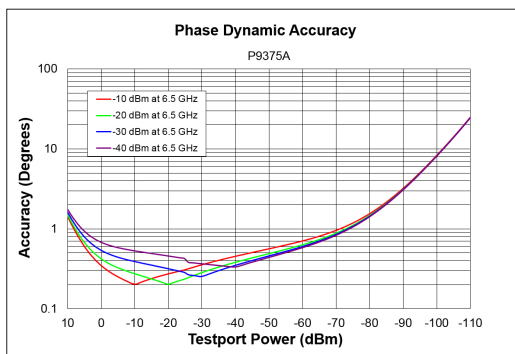
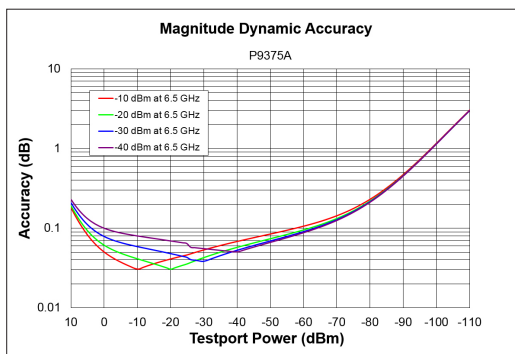

## Dynamic Accuracy, 9 GHz (magnitude and phase)

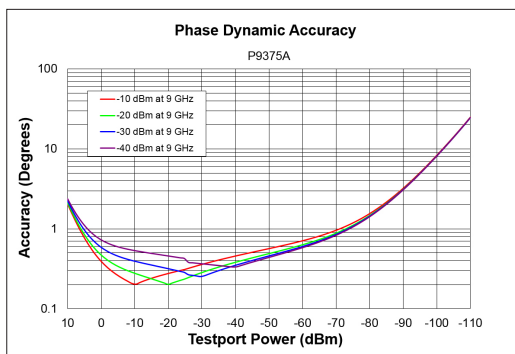
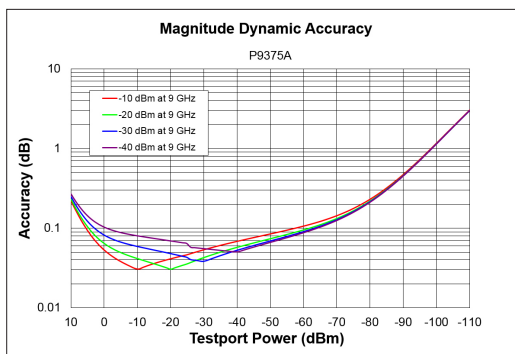



### Dynamic Accuracy, 14 GHz (magnitude and phase)

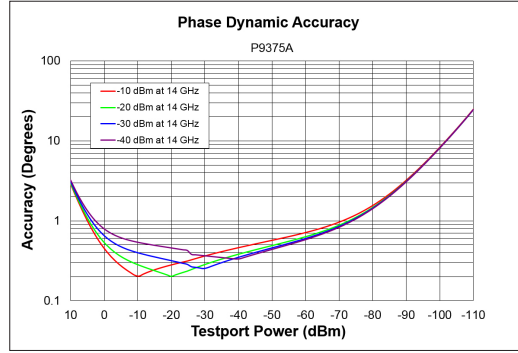
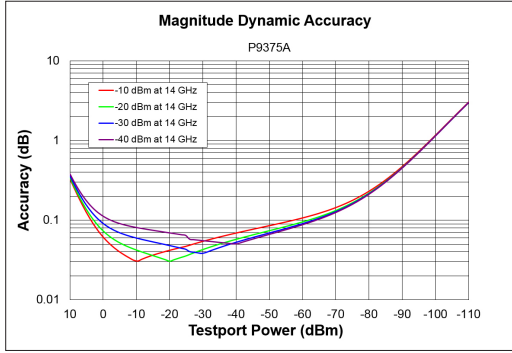

### Dynamic Accuracy, 20 GHz (magnitude and phase)

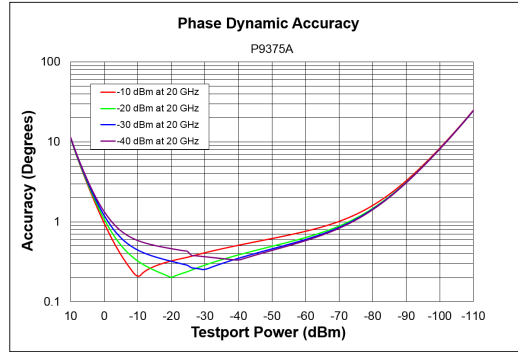
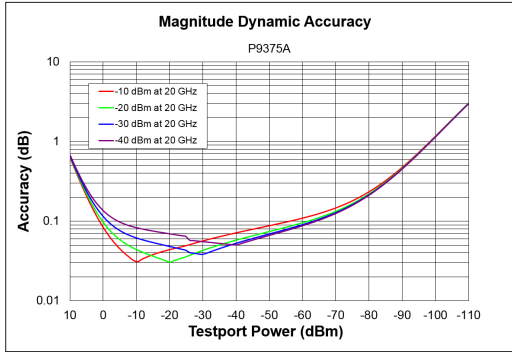

### Dynamic Accuracy, 26.5 GHz (magnitude and phase)

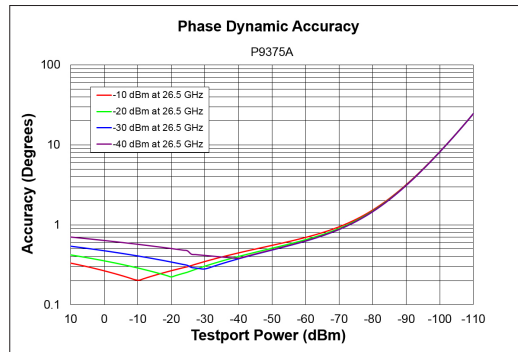
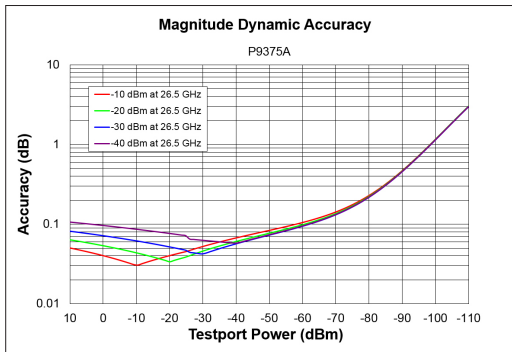

Table 26. System requirements

<b>External PC System Requirement</b>	
Operating systems	Windows 10 (64 bit)
Processor speed	Intel Core i7 10th Generation or later recommended
Available memory	4 GB minimum, 16 GB recommended
Available disk space	4 GB minimum
Display resolution	1024 X 768 minimum
USB	USB 3.0 port directly connected to Intel chipset
<b>Instrument Drivers</b>	
Keysight IO libraries	Keysight IO Libraries Suite 2022 update 1 (18.2.28014.7) or later The latest Keysight IO library suite is available at: <a href="http://www.keysight.com/find/iosuite">www.keysight.com/find/iosuite</a>

Table 27. Environmental and physical specifications

Description	Samples of this product have been type tested in accordance with the Keysight Environmental Test Manual and verified to be robust against the environmental stresses of Storage, Transportation and End-use; those stresses include, but are not limited to, temperature, humidity, shock, vibration, altitude, and power line conditions.	
	Test Methods are aligned with IEC 60068-2 and levels are similar to MIL-PRF-28800F Class 3.	
Temperature	Operating	0 to 55 °C ambient 10 to 70 °C instrument temperature
	Non-operating	-40 to +70 °C
Humidity	Type tested at 95%, +40 °C (non-condensing)	
Altitude – Operating	Up to 10,000 feet (4,572 meters)	
Altitude – Non-operating	Up to 10,000 feet (4,572 meters)	
Intrusion protection	IP 30 IEC/EN 60529	
Warm-up time	60 minutes	
Connectors	RF In and RF Out	3.5 mm female
	LO In and LO Out	SMA female
	Trig. In and Trig. Out, Trig. Ready	SMB male

Table 28. Regulatory and safety compliance

<b>EMC</b>	<p>Complies with the essential requirements of the European EMC Directive as well as current editions of the following standards (dates and editions are cited in the Declaration of Conformity):</p> <ul style="list-style-type: none"> <li>- IEC/EN 61326-1</li> <li>- CISPR Pub 11 Group 1, class A</li> <li>- AS/NZS CISPR 11</li> <li>- ICES/NMB-001 This ISM device complies with Canadian ICES-001. Cet appareil ISM est conforme a la norme NMB-001 du Canada.</li> </ul> <p>South Korean Class A EMC declaration: This equipment has been conformity assessed for use in business environments. In a residential environment, this equipment may cause radio interference.</p> <p style="text-align: center;"><b>A급 기기</b> (업무용 방송통신기자재)</p> <p>이 기기는 업무용(A급) 전자파적합기기로서 판매자 또는 사용자는 이 점을 주의하시기 바라며, 가정외의 지역에서 사용하는 것을 목적으로 합니다.</p>
<b>Safety</b>	<p>Acoustic statement (European Machinery Directive)</p> <ul style="list-style-type: none"> <li>- Acoustic noise emission</li> <li>- LpA &lt; 70 dB</li> <li>- Operator position</li> <li>- Normal operation mode per ISO 7779</li> <li>- Complies with the following standard (dates and editions are cited in the Declaration of Conformity): IEC/EN 61010-1.</li> </ul>
<b>Instrument Calibration Cycle</b>	1 Year

Table 29. Physical size and weight

Dimensions	P937XA	Note
Width	176 mm (6.9 in.)	
Height	48 mm (1.9 in.)	
Depth	333 mm (13.1 in.)	
<b>Weight</b>	1.90 kg (4.20 lbs)	

Table 30. Electrical power

Total Power Dissipation	Dissipation
Wall outlet	120 V, 52 W max 240 V, 62 W max
Rear panel DC connector	15 V, 42 W

Table 31. Front panel information

Description	General Characteristics	Typical
<b>Test ports - RF port 1 or port 2</b>		
Connector	3.5 mm female	
Impedance	50 $\Omega$ (nominal)	
Damage level	> +20 dBm, > $\pm$ 35 VDC, 1000 Volts ESD	
<b>LO ports - LO In &amp; LO Out</b>		
Connector	SMA female	
Impedance	50 $\Omega$ (nominal)	
Damage level	> +5 dBm, $\pm$ 35 VDC, sensitive to ESD	
<b>External reference input</b>		
Connector	SMB	
Input frequency	10 MHz	
Input amplitude range		-15 dBm to +5 dBm (nominal)
Impedance		50 $\Omega$ (nominal), AC coupled
Lock range		$\pm$ 10 ppm of external reference frequency (nominal)
<b>External reference out</b>		
Connector	SMB	
Output frequency	10 MHz	
Output amplitude		+10 dBm
Impedance		50 $\Omega$ (nominal), AC coupled
<b>Trigger input</b>		
Connector	SMB	
Trigger type	Edge	
Impedance		1 K $\Omega$ (nominal), DC coupled
Level range		3.3 V TTL
Rising edge		1.7 V (nominal)
Falling edge		1 V (nominal)
<b>Trigger out</b>		
Connector	SMB	
Level range		3.3 V TTL
<b>Ready for trigger out</b>		
Connector	SMB	
Impedance		50 $\Omega$ (nominal), DC coupled
Level range		3.3 V TTL

Table 32. Rear panel information

Description	Typical Performance
USB ports	Type A female (USB 2.0 only, Downstream-facing) Type C female (USB 3.0 only, Upstream-facing)
Power connector	Kycon KPJX-4S-S DC power connector (4 Pins)
10 MHz In (SMB Male)	10 MHz $\pm$ 25 ppm (not used by P937xA)
10 MHz Out (SMB Male)	10 MHz $\pm$ 25 ppm (not used by P937xA)
Trig 1 (SMB Male)	3.3 V CMOS (TTL compatible, 5 V tolerant)
Trig 1 (SMB Male)	3.3 V CMOS (TTL compatible, 5 V tolerant)

Table 33. Measurement speed (milliseconds)<sup>1</sup>

Description	Typical				
<b>Typical cycle time (0.8 – 1.8 GHz frequency span, 1 kHz IF bandwidth, includes data transfer)</b>					
Number of points	201	401	801	1601	16001
Uncorrected	214	420	831	1658	16507
2-port calibration	424	835	1661	3309	33258
<b>Typical cycle time (0.8 – 1.8 GHz frequency span, 100 kHz IF bandwidth, includes data transfer)</b>					
Number of points	201	401	801	1601	16001
Uncorrected	14.1	23.6	41.0	77.2	693.0
2-port calibration	24.1	43.0	79.0	147.3	1871.1
<b>Typical cycle time (0.8 – 1.8 GHz frequency span, 600 kHz IF bandwidth, includes data transfer)</b>					
Number of points	201	401	801	1601	16001
Uncorrected	13.8	23.5	40.1	76.1	688.5
2-port calibration	23.2	42.3	77.5	145.2	1825.2
<b>Typical cycle time (full frequency span, 100 kHz IF bandwidth, no calibration, includes data transfer)</b>					
Number of points	201	401	801	1601	16001
P9370A 300 kHz to 4.5 GHz	18.0	26.0	43.8	80.5	700.6
P9371A 300 kHz to 6.5 GHz	18.8	28.1	43.8	81.0	700.2
P9372A 300 kHz to 9 GHz	19.0	28.6	44.7	81.6	709.6
P9373A 300 kHz to 14 GHz	19.7	29.0	45.0	82.3	714.0
P9374A 300 kHz to 20 GHz	20.3	29.5	47.1	83.0	722.5
P9375A 300 kHz to 26.5 GHz	21.1	31.3	48.6	84.2	725.3

1. Measured using a host PC with Intel core i7 2.90 GHz Gen 7 CPU and 64 GB RAM running Windows 10 (64 bit), with Keysight VNA firmware version A.13.10.01. Data transfer includes real and imaginary pairs, and includes transferring four S-parameters for the 2-port calibrations. Uncorrected measurements are for one sweep direction and transferring the corresponding two S-parameters.

Table 33. Measurement speed (milliseconds) (continued)<sup>1</sup>

Description	Typical				
<b>Typical cycle time (full frequency span, 600 kHz IF bandwidth, no calibration, includes data transfer)</b>					
Number of points	201	401	801	1601	16001
P9370A 300 kHz to 4.5 GHz	16.4	24.4	42.4	77.0	700.2
P9371A 300 kHz to 6.5 GHz	17.4	25.8	44.0	79.0	704.3
P9372A 300 kHz to 9 GHz	17.8	26.0	44.7	79.5	705.1
P9373A 300 kHz to 14 GHz	19.5	26.6	46.0	80.5	710.6
P9374A 300 kHz to 20 GHz	20.2	27.0	46.2	80.7	721.3
P9375A 300 kHz to 26.5 GHz	21.0	28.9	47.0	81.2	722.9
<b>Typical cycle time (full frequency span, 600 kHz IF bandwidth, 2-port calibration, includes data transfer)</b>					
Number of points	201	401	801	1601	16001
P9370A 300 kHz to 4.5 GHz	26.6	44.0	82.0	150.4	1440.2
P9371A 300 kHz to 6.5 GHz	28.6	47.1	86.2	153.3	1461.7
P9372A 300 kHz to 9 GHz	30.2	51.1	90.2	156.2	1482.0
P9373A 300 kHz to 14 GHz	32.2	55.2	94.0	160.2	1501.2
P9374A 300 kHz to 20 GHz	34.2	59.2	98.1	163.2	1520.2
P9375A 300 kHz to 26.5 GHz	38.7	62.2	100.1	167.2	1540.3

1. Measured using a host PC with Intel core i7 2.90 GHz CPU and 64 GB RAM running Windows 10 (64 bit), with Keysight VNA firmware version A.13.10.01. Data transfer includes real and imaginary pairs, and includes transferring four S-parameters for the 2-port calibrations. Uncorrected measurements are for one sweep direction and transferring the corresponding two S-parameters.

## Table 34. Measurement capabilities

### Multiport Measurements with S97551B Software

When the S97551B software is installed, the P937xA USB VNA has the ability to be configured into a multiport network analyzer. Adding a second instrument would provide additional test ports to the network analyzer. This configuration provides a full featured 4-port vector network analyzer capability. Configurations of up to two instruments with four test ports have been demonstrated.

For four-port operation with two P937xA VNAs, all specification apply except cross-instrument trace noise. Cross-instrument trace noise can not be tested on individual instruments. However, four-port trace noise performance will typically meet the two-port specifications.

### Anticipated Nominal Multiport Performance

The guidance provided here is given as general reference based on Keysight's internal evaluation of multiport USB VNA configurations. Every USB VNA is tested as an individual 2-port VNA to meet or exceed the performance parameters defined within the data sheet. Multiport setups using multiple USB VNAs are not tested as a multi-port instrument in the factory.

In the table below:

- A check mark, ✓, indicates the performance parameter is the same as the corresponding 2-port performance.
- A filled in square, ■, indicates nominal performance parameter that is anticipated to meet 2-port performance.

P937xA USB VNA Multiport Configuration	
Performance parameter	Setups with 4 ports (2 instruments)
Source max power	✓
Noise floor	✓
Dynamic range	✓
Trace noise	■
Receiver compression	✓
Source power accuracy/linearity	✓
Frequency accuracy	✓
Dynamic accuracy	✓
Uncorrected directivity	✓
Uncorrected load match	✓
Uncorrected source match	✓
Crosstalk <sup>1</sup>	✓
Tracking terms	✓
Receiver stability	✓
0.1 dB receiver compression	✓
Source phase noise	✓
Source harmonics	✓
LO Power Out/In	✓

1. Cross instrument crosstalk performance is expected to exceed the single-instrument crosstalk specification.

### Multisite Operation

Multi-site operation is the ability to configure multiple independent USB VNAs to operate independently on a single controller via USB connection. Up to two independent USB VNA instances per PC have been demonstrated, allowing parallel testing of devices. Each instance of an independent USB VNA can have different number of ports, and can be triggered synchronously, or asynchronously.

Table 35. Miscellaneous information

Description	Information
Data points	100,001 (using PC with 64-bit OS)
IF bandwidths	1 Hz to 1.2 MHz
Aperture (selectable)	frequency span)/(number of points -1)
Maximum aperture	20% of frequency span
Range	0.5 x (1/minimum aperture)
Maximum delay	Limited to measuring no more than 180o of phase change within the minimum aperture
<b>Display range</b>	
Magnitude	± 2500 dB (at 500 dB/div), max
Phase	± 2500° (at 500 degrees/div), max
Polar	10 pUnits (min), 10,000 Units (max)
<b>Display resolution</b>	
Magnitude	0.001 dB/div, min
Phase	0.001°/div, min
<b>Marker resolution</b>	
Magnitude	0.001 dB, min
Phase	0.01°, min
Polar	10 pUnit, min

Table 36. Software

Description	Information
Keysight IO library	The IO library suite offers a single entry point for connection to the most common instruments including AXIe, PXI, GPIB, USB, Ethernet/LAN, RS-232, and VXI test instrument from Keysight and other vendors. It automatically discovers interfaces, chassis, and instruments. The graphical user interface allows you to search for, verify, and update IVI instrument and soft front panel drivers for modular and traditional instruments. The IO suite safely installs in side-by-side mode with NI I/O software. Free software download at <a href="http://www.keysight.com/find/iosuite">www.keysight.com/find/iosuite</a>
Keysight soft front panel	The USB VNA includes a soft front panel (SFP), a software based graphical user interface (GUI) which enables the instrument's capabilities from your PC. Included on CD-ROM shipped with module or online
Command Expert	Assists in finding the right instrument commands and setting correct parameters. A simple interface includes documentation, examples, syntax checking, command execution, and debug tools to build sequences for integration in Excel, MATLAB, LabVIEW, VEE, and System VUE. Free software download at <a href="http://www.keysight.com/find/commandexpert">www.keysight.com/find/commandexpert</a>
Example programs	Setting up a measurement Guided calibration Data acquisition Data transfer Included on CD-ROM shipped with module, or online at <a href="http://www.keysight.com/find/usb-vna">www.keysight.com/find/usb-vna</a>
Example programming languages	C, C++, C#, VB, LabVIEW



## Literature Information

<i>P937XA Streamline Series USB Vector Network Analyzer Configuration Guide</i>	5992-2663EN
<i>Keysight Network Analyzer Selection Guide</i>	5989-7603EN
<i>Electronic Calibration (ECal) Modules for Vector Network Analyzer Technical Overview</i>	5963-3743E
<i>Streamline Series USB Vector Network Analyzers Product Fact Sheet</i>	5992-2663EN

## Web Resources

[www.keysight.com/find/usb-vna](http://www.keysight.com/find/usb-vna)

[www.keysight.com/find/na](http://www.keysight.com/find/na)

[www.keysight.com/find/ecal](http://www.keysight.com/find/ecal)

[www.keysight.com/find/mta](http://www.keysight.com/find/mta)