

Product Datasheet - Technical Specifications



More information in our Web-Shop at ► www.meilhaus.com

Your contact

Technical and commercial sales, price information,
quotations, demo/test equipment, consulting:

Tel.: +49 - (0)81 41 - 52 71-0

E-Mail: sales@meilhaus.com

Meilhaus Electronic GmbH
Am Sonnenlicht 2
82239 Alling/Germany

Tel. +49 - (0)81 41 - 52 71-0 E-
Mail sales@meilhaus.com

Mentioned company and product names may be registered trademarks of the respective companies. Errors and omissions excepted. © Meilhaus Electronic.

PROBES AND ACCESSORIES

For Rohde & Schwarz oscilloscopes



Product Brochure
Version 17.00

ROHDE & SCHWARZ

Make ideas real



AT A GLANCE

Test applications for oscilloscopes range from debugging complex electronic circuits to measuring the signal integrity of high-speed bus signals and characterizing power electronics with dangerous voltage levels. Measurement accuracy and operator safety depend on the probes and accessories that are used.

Rohde&Schwarz passive probes are the perfect accessory for general measurement applications involving low-frequency signals. The very fine, spring-loaded tip allows precise and reliable contacting of signal lines.

Active broadband probes are ideal for applications where low loading on the DUT is crucial or when the measured signal contains high-frequency signal components. Rohde&Schwarz broadband probes feature a very low load and a wide dynamic range. The integrated, high-precision DC voltmeter permits fast and easy testing (both differential and single-ended) of DC voltage levels on signal lines, irrespective of the oscilloscope settings. The configurable, integrated micro button makes it easy to operate the oscilloscope when measuring with multiple probes. An extensive range of probe accessories ensures optimal contacting.

Operator safety is the highest priority during measurements on power electronics. Rohde&Schwarz offers high voltage probes and current probes for measurements up to CAT III.

EMC near-field probes open a new application field for oscilloscopes. High sensitivity and the powerful spectrum analysis function make the R&S®RTO oscilloscopes a valuable tool for analyzing EMC problems when used in conjunction with near-field probes.

KEY FACTS

- ▶ Probes for every application: differential or single-ended voltage measurements, current measurements, EMC near-field measurements
- ▶ Active probes with very low load due to high input impedance of up to $1\text{ M}\Omega \parallel 0.3\text{ pF}$ and wide dynamic range of $\pm 8\text{ V}$
- ▶ Modular broadband probes with low capacitive loading and flexible and configurable connectivity
- ▶ R&S®ProbeMeter: integrated voltmeter with 0.1% measurement uncertainty for precise DC measurements
- ▶ Simple operation using the configurable micro button
- ▶ Comprehensive accessories for maximum flexibility during contacting
- ▶ Passive probes included with every Rohde & Schwarz oscilloscope

MODELS



Passive probes
▶ page 8

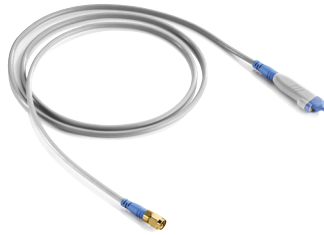

Passive broadband probes
▶ page 10



Active broadband probes
▶ page 12



Modular broadband probes
▶ page 18



Power rail probe
▶ page 20



Multi-channel power probe
▶ page 22



High voltage probes
▶ page 26



Current probes
▶ page 30



EMC near-field probes
▶ page 32

SELECTING THE RIGHT PROBE

The first step in selecting the right probe is to analyze the measurement task. Is a single-ended or a differential measurement needed? Which maximum frequency components need to be transferred? What is the maximum input voltage that can occur?

Differential or single-ended measurement

Differential probes make measurements possible when neither of the two test points is connected to ground. An example is voltage measurements on components without a connection to ground, which is necessary when characterizing switching power supplies. Differential probes are also needed for low-noise measurements on differential signals.

Differential probes can in fact also be used for single-ended measurements. Single-ended probes often offer a higher input impedance, a lower input capacitance and the advantage of a wider dynamic range.

Bandwidth and rise time

Bandwidth is one of the most important parameters when selecting a probe. It defines the cutoff frequency after which a signal will be displayed more than 3 dB (approx. 30%) weaker than it actually is. For an accurate signal representation, the cutoff frequency of the measurement system (oscilloscope and probe) must be greater than the highest frequency component to be displayed. When measuring digital signals, the measurement bandwidth should be 3 to 5 times greater than the clock rate (For debugging a digital design, a bandwidth that is 3 times greater is sufficient. For conformance tests on digital interfaces, the bandwidth must be 5 times greater than the clock rate.).

When measuring fast slopes, such as when characterizing switching power supplies, the critical parameter is the rise time of the measurement system (oscilloscope and probe). For precise measurements, the rise time of the measurement system should be a factor of 3 to 5 times lower than the rise time of the pulse being measured.

Dynamic range

The dynamic range of a probe is defined as the maximum measurable input voltage. It is specified for DC voltage and often decreases as the frequency increases. In the case of differential probes, a distinction is also made between common mode and differential mode dynamic range. The common mode dynamic range determines the valid input voltage range for a single differential input, measured with reference to ground. The differential mode dynamic range defines the maximum measurable input differential voltage.

To accurately measure steep, large-amplitude slopes, a sufficiently wide dynamic range must be available at high frequencies. When measuring the residual ripple of DC switching power supplies, very small signals with a large DC component must also be measured. To make the full A/D converter resolution available, modern probes have the option to feed in a DC offset.

In the case of high voltage probes, operator safety is a key consideration. High voltage probes therefore have special insulation, protection against accidental contact and other protective mechanisms. These probes are characterized by the maximum voltage to ground and by the measurement category. The measurement category defines the measurement environments in which the operator is still protected. A probe may only be used in the measurement categories for which it is defined.



Load on the device under test

A measurement system must not excessively load the circuit under test, both to prevent degraded signals and to ensure that the functioning of the DUT is not impaired. The key is to use probes with a high input impedance and a low input capacitance. The resulting input impedance is highly dependent on the frequency and is typically less than $500\ \Omega$ at the probe's cutoff frequency.

Passive probes typically have an input impedance of $10\ \text{M}\Omega$ and an input capacitance of $> 10\ \text{pF}$. Active probes typically have an input capacitance of $< 1\ \text{pF}$ at an input impedance of $1\ \text{M}\Omega$ and are especially suited for measurements on circuits with high-speed signals $> 100\ \text{MHz}$. For the measurement, it is important to select the right probe accessories for contacting with the DUT. Long pins and leads increase the capacitance and inductance, lower the maximum measurement bandwidth and lead to excessive overshoot and ringing artifacts at the pulse slopes.

Expanded functions and probe accessories

In addition to the performance parameters, the supplemental functions for simplifying daily tasks must be considered. Examples include an integrated digital voltmeter or a micro button. The functionality of the micro button can be configured to allow direct control of the oscilloscope from the probe.

The diverse accessories offer flexibility during test point contacting, make the operator's day-to-day work easier and help prevent measurement errors. Available accessories include rigid and spring-loaded tips, browsers, adapters and extension leads. Rohde&Schwarz offers a comprehensive set of accessories for every probe.



Probes	Interface	Oscilloscope family (R&S®)	
		RTH1000	RTC1000/RTB2000
Passive probes			
▶ page 8			
R&S®RT-ZP1X	BNC		
R&S®RT-ZI10/10C/11	BNC		
R&S®RT-ZP03S/05S	BNC		
R&S®RTM-ZP10	BNC		
R&S®RT-ZP10	BNC		
Passive broadband probes			
▶ page 10			
R&S®RT-ZZ80	SMA/BNC		
Active broadband probes			
▶ page 12			
R&S®RT-ZS10L ¹⁾	BNC		
R&S®RT-ZS10E/10/20/30/60	Rohde & Schwarz probe interface		
R&S®RT-ZD10/20/30/40	Rohde & Schwarz probe interface		
Modular broadband probes			
▶ page 18			
R&S®RT-ZM15/30/60/90/130/160	Rohde & Schwarz probe interface		
Power rail probe			
▶ page 20			
R&S®RT-ZPR20/40	Rohde & Schwarz probe interface		
Multi-channel power probe			
▶ page 22			
R&S®RT-ZVC02/04	R&S®RTE/R&S®RTO MSO interface		
High voltage probes			
▶ page 26			
R&S®RT-ZH03/10/11	BNC		
R&S®RT-ZD01			
R&S®RT-ZHD07/15/16/60	Rohde & Schwarz probe interface		
Current probes			
▶ page 30			
R&S®RT-ZC02/03	BNC		
R&S®RT-ZC10/20/30/31	BNC		
R&S®RT-ZC05B/10B/15B/20B	Rohde & Schwarz probe interface		
EMC near-field probes			
▶ page 32			
R&S®HZ-15/17	BNC		

¹⁾ Probe requires 50 Ω input coupling. For oscilloscopes with 1 MΩ input, a BNC feedthrough termination adapter is required.

²⁾ Requires R&S®RT-Z1M 1 MΩ adapter.

 Recommended

 Usable

RTM3000/RTA4000	RTE	RTO	RTP
			2)
			2)
			2)
			2)
			2)
			2)

PASSIVE PROBES

Passive probes are standard accessories for Rohde&Schwarz oscilloscopes. They are low-cost, general purpose probing solutions for a broad range of applications.

Universal application

Rohde&Schwarz passive probes are the all-rounders in the world of probes. They are low-cost, general purpose probing solutions for a broad range of applications. The BNC connector allows them to be used on almost any oscilloscope. Passive probes with readout pin enable Rohde&Schwarz oscilloscopes to automatically detect the attenuation factor. A spring-loaded tip ensures good contact with the DUT.



Passive probes: the all-rounders for every oscilloscope



R&S®RT-ZA4 mini clips and R&S®RT-ZA5 micro clips for reliable contacting, especially when using multiple probes



Extensive R&S®RT-ZA1 accessory set for optimal contacting

Individual adjustment for precise measurements

In order to achieve optimum measurement accuracy, passive probes with a probe bandwidth larger than 350 MHz must be adjusted to the input impedance of the oscilloscope. Rohde&Schwarz offers the R&S®RTM-ZP10 and the R&S®RT-ZP10 500 MHz passive probes, which are pre-adjusted for the R&S®RTM and the R&S®RTP/RTO/RTE/RTA oscilloscopes, respectively.

Extensive accessories

For optimal contacting, Rohde&Schwarz offers the R&S®RT-ZA1 accessory set for passive probes. It includes spare spring-loaded tips, rigid tips, ground contact springs, ground leads and color-coded rings.

Model	Bandwidth	Attenuation factor	Input impedance	Dynamic range	Comment	Order No.
Probes						
R&S®RT-ZP1X	38 MHz	1:1	1 MΩ 39 pF	55 V (RMS) CAT II	2.5 mm probe tip, spring-loaded	1333.1370.02
R&S®RT-ZP03S	300 MHz	10:1	10 MΩ 12 pF	400 V (RMS)/55 V (RMS)	robust 5 mm probe tip, no readout	1803.1001.02
R&S®RT-ZP05S	500 MHz	10:1	10 MΩ 10 pF	300 V (RMS)	5 mm probe tip, spring-loaded	1333.2401.02
R&S®RTM-ZP10	500 MHz	10:1	10 MΩ 9.5 pF	400 V (RMS), 300 V (RMS) CAT II	2.5 mm probe tip, spring-loaded, preadjusted for R&S®RTM	1409.7708.02
R&S®RT-ZP10	500 MHz	10:1	10 MΩ 9.5 pF	400 V (RMS), 300 V (RMS) CAT II	2.5 mm probe tip, spring-loaded, preadjusted for R&S®RTO/RTE/RTA	1409.7550.00
R&S®RT-ZI10	500 MHz	10:1	10 MΩ 12 pF	600 V (RMS) CAT IV, 1000 V (RMS) CAT III	for R&S®Scope Rider RTH	1326.1761.02
R&S®RT-ZI10C	500 MHz	10:1	10 MΩ 11 pF	300 V (RMS) CAT III	compact laboratory probe, for R&S®Scope Rider RTH	1326.3106.02
R&S®RT-ZI10C-2	500 MHz	10:1	10 MΩ 11 pF	300 V (RMS) CAT III	dual-pack of R&S®RT-ZI10C	1333.1811.02
R&S®RT-ZI10C-4	500 MHz	10:1	10 MΩ 11 pF	300 V (RMS) CAT III	quad-pack of R&S®RT-ZI10C	1333.1328.02
Accessories						
R&S®RT-ZA1					accessory set for R&S®RTM-ZP10/RT-ZP10/RT-ZP1X	1409.7566.02
R&S®RT-ZA4					mini clips	1416.0428.02
R&S®RT-ZA5					micro clips	1416.0434.02
R&S®RT-ZA6					lead set	1416.0440.02
R&S®RT-ZA21					extension set for R&S®RT-ZI10/RT-ZI11	1326.1984.02
R&S®RT-ZA40					probe tip accessory set for R&S®RT-ZP03S/-ZP05S/-ZH03, includes rigid and flexible probe tips	1338.0742.02

PASSIVE BROADBAND PROBES

Low noise, high linearity and a purely passive implementation make passive broadband probes an economical solution for measuring controlled impedance lines. The compact design facilitates measurements on densely packed printed boards.

Economical alternative for measurements on controlled impedance lines

Passive broadband probes are an economical, yet powerful alternative to active probes for measuring high-speed signals on low impedance lines. In contrast to active probes, their input impedance is low but remains practically constant over the entire frequency range. They feature an extremely low input capacitance and particularly low noise. Their purely passive implementation renders them highly linear and therefore ideal for spectrum analysis applications.

The R&S®RT-ZZ80 8 GHz probe provides an attenuation factor of 10:1 at an input impedance of $500 \Omega \parallel 0.3 \text{ pF}$. Its SMA plug is connected to the oscilloscope via the provided SMA-BNC adapter. The probe can be easily selected as a predefined probe from the R&S®RTO oscilloscope menu. And with these simple steps, the instrument is correctly configured.

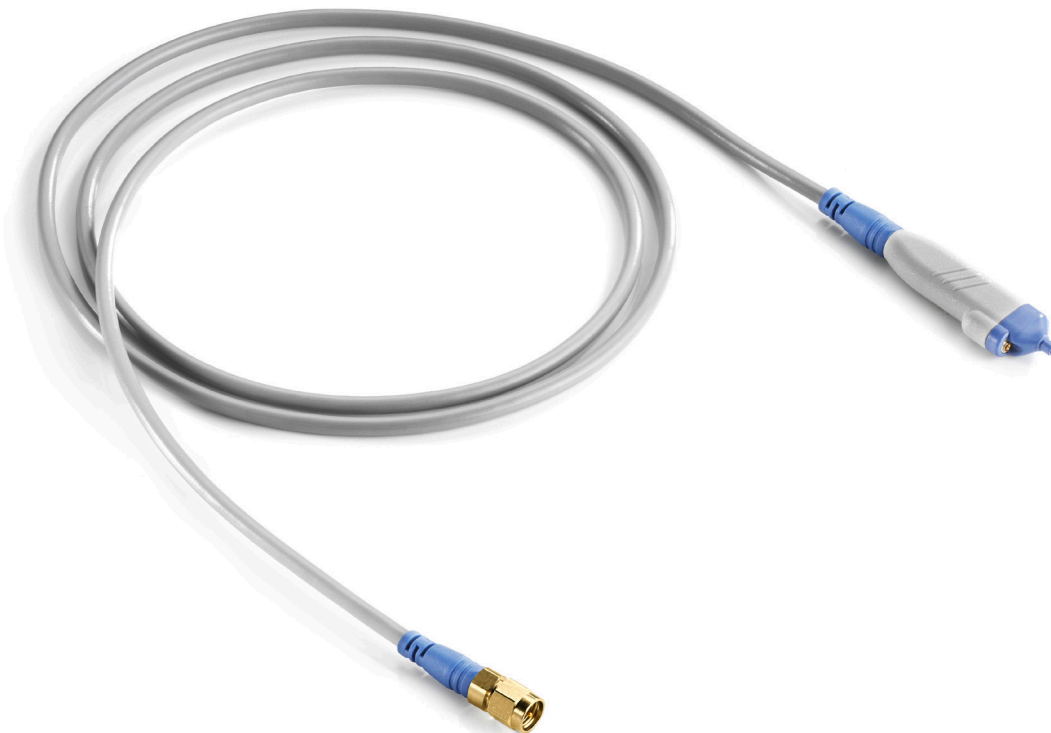

Passive broadband probes: powerful alternative for measurements on controlled impedance lines

Maximum bandwidth through customized accessories

The maximum probe bandwidth is typically defined by the accessories that are used. Rohde & Schwarz supplies accessories tailored to both the probe and the application to ensure that the maximum bandwidth is available for various contacting methods. The extensive standard accessories for the R&S®RT-ZZ80 include solder-in pins, rigid tips, solder-in ground pins, spring-loaded ground tips and adapters for pin connectors. Because all probe tips have the same design, the R&S®RT-ZZ80 accessories are compatible with both single-ended and differential active probes (R&S®RT-ZS60 and R&S®RT-ZD40).

Input impedance versus frequency

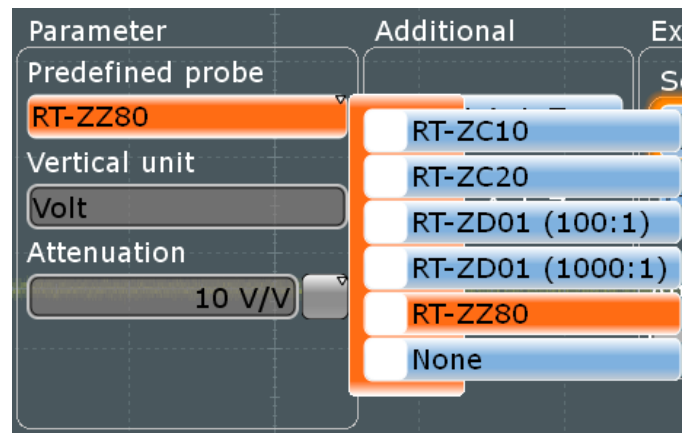
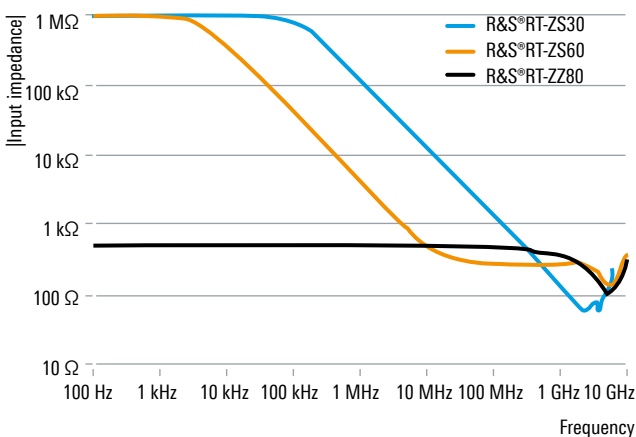

Selecting predefined probes with SMA or BNC connector on the R&S®RTO

Model	Bandwidth	Attenuation factor	Input impedance	Dynamic range	Comment	Order No.
Probe						
R&S®RT-ZZ80	8 GHz	10:1	500 Ω 0.3 pF	20 V (RMS) max. input voltage	SMA-BNC adapter included	1409.7608.02

ACTIVE BROADBAND PROBES

Rohde & Schwarz offers an extensive range of active broadband probes with high input impedance of 1 M Ω , low input capacitance of < 1 pF and a wide dynamic range. Useful supplemental functions, such as offset compensation in the probe, an integrated, high-precision voltmeter and a micro button for convenient control of the oscilloscope, set these probes apart.

Designed for high bandwidths

High-bandwidth probes are only possible through the use of application-specific integrated circuits (ASIC). Rohde & Schwarz designs these ASICs with particular attention to performance. Low noise, high DC accuracy and minimal drift versus temperature and time are the result. Individual laser trimming of the probes during production results in particularly high accuracy and a very flat frequency response. The design of the contact accessories also permits a high measurement bandwidth for various contacting methods, including manual contacting, solder-in and plug-in connections. The compact probe head allows measurements even on densely populated printed boards, and the low weight ensures a minimal load at the contact point.

Minimal influence on the measurement signal

When measuring the high-speed signals used in modern electronic designs, the load from the probe must be kept low. Rohde & Schwarz active probes meet this requirement with 1 M Ω input impedance and an input capacitance of < 1 pF. As a result, the probe's influence on the circuit during measurement is minimized. The optimized design of the probe tips and accessories ensures accurate rise times and minimizes overshoot and ringing.

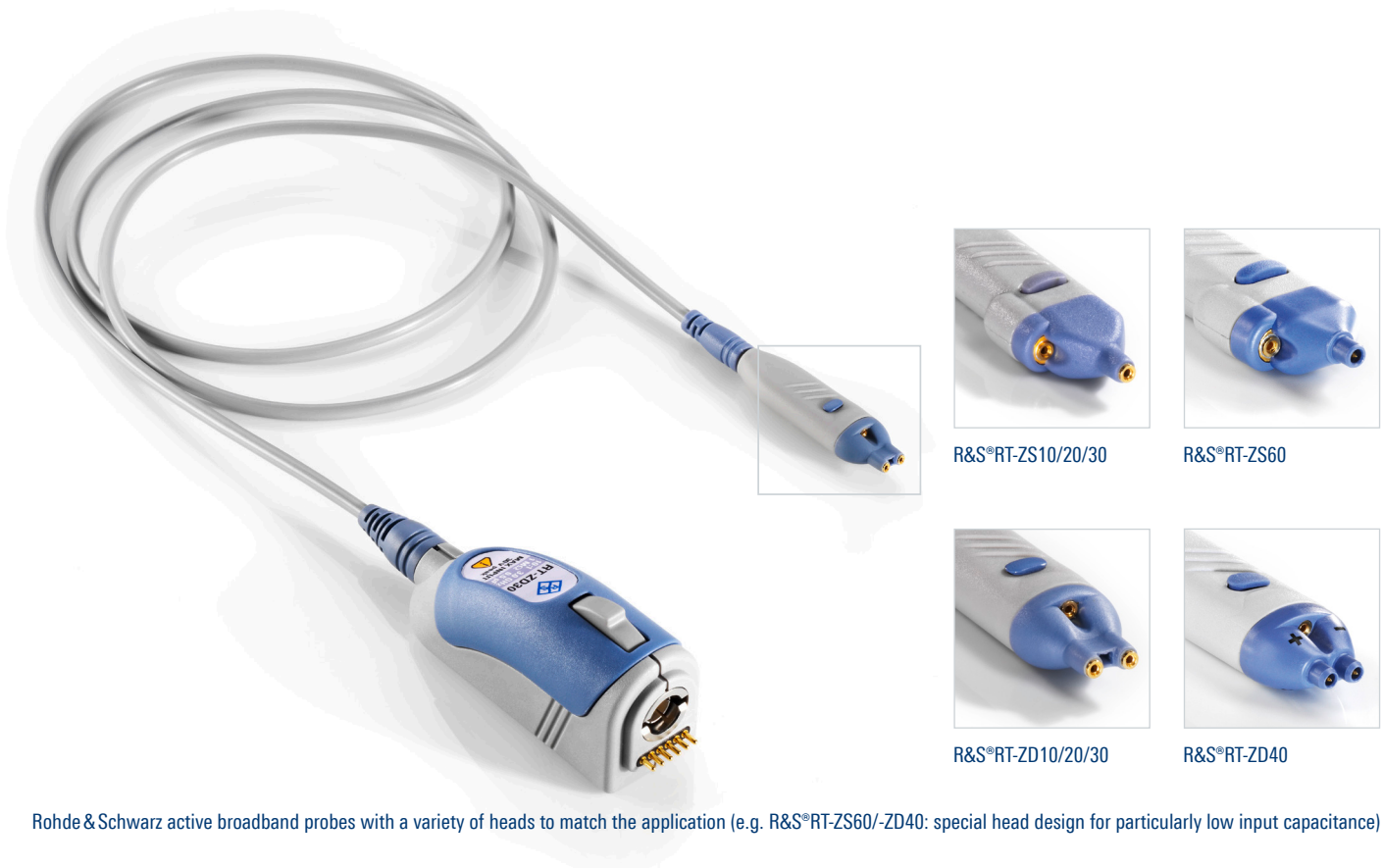

Wide dynamic range and high linearity: perfect for spectrum analysis

All Rohde&Schwarz active broadband probes exhibit a wide dynamic range, which is also available at high frequencies. This means that even very fast signals and steep, high-amplitude pulse slopes can be measured. For measurements involving particularly stringent linearity requirements (such as FFT analyses using the R&S®RTO oscilloscopes), an excellent choice is the R&S®RT-ZS60 single-ended probe with its exceptionally high linearity (THD of -70 dB at 16 V (peak-to-peak) at 1 GHz). The optional R&S®RT-ZA9 N(m) adapter allows Rohde&Schwarz broadband probes to be used with spectrum and signal analyzers.

Integrated micro button for convenient instrument control

Measuring with multiple probes often requires a third hand to operate the oscilloscope. The integrated micro button on the probe tip solves this problem. It can be configured on Rohde&Schwarz oscilloscopes to perform a variety of functions, such as run/stop, auto set or save waveform.

R&S®ProbeMeter: integrated, high-precision voltmeter

The integrated voltmeter is unique to Rohde&Schwarz active probes. It operates independently of the oscilloscope and measures the DC component of a signal with an accuracy of 0.1%. The full dynamic range of the R&S®ProbeMeter is always available, irrespective of the oscilloscope settings. As a result, supply voltages and operating points can be quickly and precisely measured and, with the press of a button, the DC component can be automatically compensated for AC measurements – with optimal dynamic range. In the case of differential probes, the DC components of both the differential and the common mode component of the input signal can be measured simultaneously.

Integrated memory and future-ready probe interface

Rohde&Schwarz active broadband probes have a data memory that is loaded with probe-specific calibration data. This ensures maximum accuracy and allows automatic probe detection. Active probes have a probe interface with a precision BNC-compatible connector that can transmit signals up to 18 GHz. These probes will also work with future Rohde&Schwarz broadband oscilloscopes.

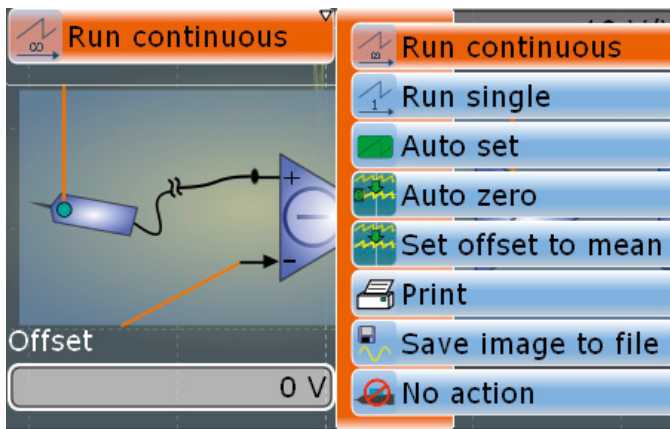

Flexible configuration of the micro button function on the oscilloscope

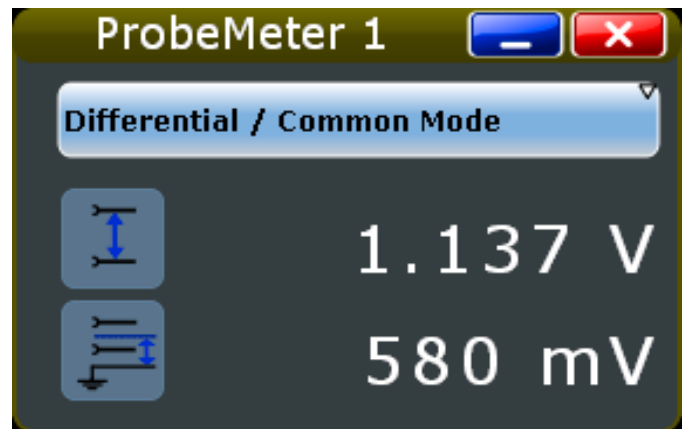

R&S®ProbeMeter: high DC measurement accuracy, independent of the instrument settings and in parallel with the measurement channel

SINGLE-ENDED BROADBAND PROBES

A particularly wide dynamic range, exceptionally low offset and gain errors and the right accessories make these probes the ideal accessory for Rohde & Schwarz oscilloscopes.

High signal fidelity with active probes

Single-ended active probes are used to accurately measure ground-referenced signals. They precisely measure both high-speed and low-frequency signals for which it is critical that the probe impedance places only a minimal load on the test point. Rohde & Schwarz offers a variety of models with a maximum bandwidth up to 6 GHz. Rohde & Schwarz single-ended active probes feature a high input impedance of 1 M Ω , a low input capacitance down to 0.3 pF and noise down to 2 mV (RMS) referenced to the input.

Wide dynamic range with additional offset compensation

In addition to the wide dynamic range, Rohde & Schwarz single-ended active probes also offer an offset compensation. As a result, the DC component of the measured signal can be compensated so that the signal components of interest are displayed on the oscilloscope at maximum resolution. The maximum input voltage of 30 V ensures that the probe is not damaged by overloads.

A low voltage, single-ended probe is typically used for measuring high-speed, ground-referenced signals up to 12 V.

Exceptionally low offset and gain errors, minimal temperature drift

Rohde & Schwarz single-ended active probes are characterized by impressively low offset and gain errors. The minimal gain drift coupled with the offset compensation permits precise measurements – even over extended periods of time and at varying temperatures. Frequent compensation during the measurement is no longer necessary, simplifying everyday measurement tasks.



Practical design: micro button for convenient instrument control
Diverse probe tips and ground cables are included as standard.

Wide dynamic range: ± 8 V, expandable with additional offset compensation of ± 12 V (± 10 V for R&S® RT-ZS60)

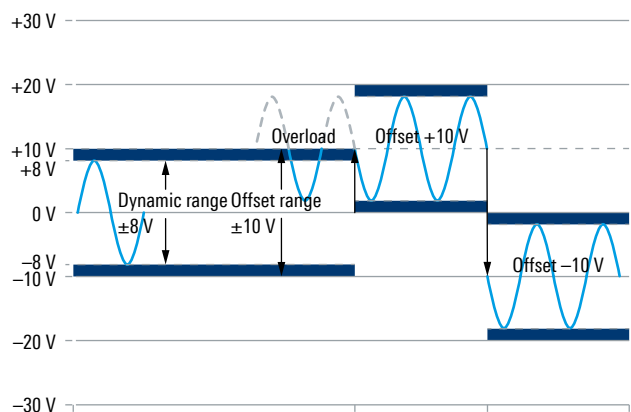

Accessories for high signal fidelity

All Rohde & Schwarz single-ended active probes come with high-quality accessories. The R&S®RT-ZS60, for example, includes signal and ground solder-in pins and probe tips. Its design enables test point contacting with particularly low input capacitance.



Extensive set of standard accessories for the R&S®RT-ZS60 single-ended probe



R&S®RT-ZA9 N(m) adapter for active broadband probes for use with signal and spectrum analyzers

Rohde & Schwarz probe interface extension set

When the R&S®RT-ZA50 and R&S®RT-ZA51 adapters are combined, they serve as an extension set for the Rohde & Schwarz probe interface. This allows Rohde & Schwarz probes to be operated at greater distances from oscilloscopes for production testing and ATE systems.



Model	Bandwidth	Attenuation factor	Input impedance	Dynamic range	Comment	Order No.
Probes						
R&S®RT-ZS10L	1 GHz	10:1	1 MΩ 0.9 pF	±8 V	BNC interface , 50 Ω output ¹⁾	1333.0815.02
R&S®RT-ZS10E	1.0 GHz	10:1	1 MΩ 0.8 pF	±8 V	Rohde & Schwarz probe interface	1418.7007.02
R&S®RT-ZS10	1.0 GHz	10:1	1 MΩ 0.8 pF	±8 V	R&S®ProbeMeter and micro button for instrument control, Rohde & Schwarz probe interface	1410.4080.02
R&S®RT-ZS20	1.5 GHz	10:1	1 MΩ 0.8 pF	(±12 V offset compensation)		1410.3502.02
R&S®RT-ZS30	3.0 GHz	10:1	1 MΩ 0.8 pF			1410.4309.02
R&S®RT-ZS60	6.0 GHz	10:1	1 MΩ 0.3 pF	±8 V (±10 V offset compensation)		1418.7307.02
Accessories						
R&S®RT-ZA2					accessory set for R&S®RT-ZS10/20E/20/30	1416.0405.02
R&S®RT-ZA3					pin set for R&S®RT-ZS10/10E/20/30	1416.0411.02
R&S®RT-ZA4					mini clips	1416.0428.02
R&S®RT-ZA5					micro clips	1416.0434.02
R&S®RT-ZA6					lead set	1416.0440.02
R&S®RT-ZA9					N(m) adapter for R&S®RT-Zxx oscilloscope probes	1417.0909.02
R&S®RT-ZA50					adapter, Rohde & Schwarz probe interface to 2.92 mm/3.5 mm/SMA	1803.5265.02
R&S®RT-ZA51					adapter, 2.92 mm/3.5 mm/SMA to Rohde & Schwarz probe interface	1803.5365.02

¹⁾ Requires 5:1 attenuation factor setting on oscilloscopes with 1 MΩ input.

DIFFERENTIAL BROADBAND PROBES

A flat frequency response and a high input impedance with low input capacitance permit precise measurements on differential signals while keeping the loading on the DUT low. The high common mode rejection over the entire probe bandwidth ensures high immunity to interference. Special browser adapters allow flexible contacting with high signal fidelity.

Typical DC equivalent circuit in an LVDS receiver

Low DC loading is key when measuring LVDS signal lines with operating points set at high impedance

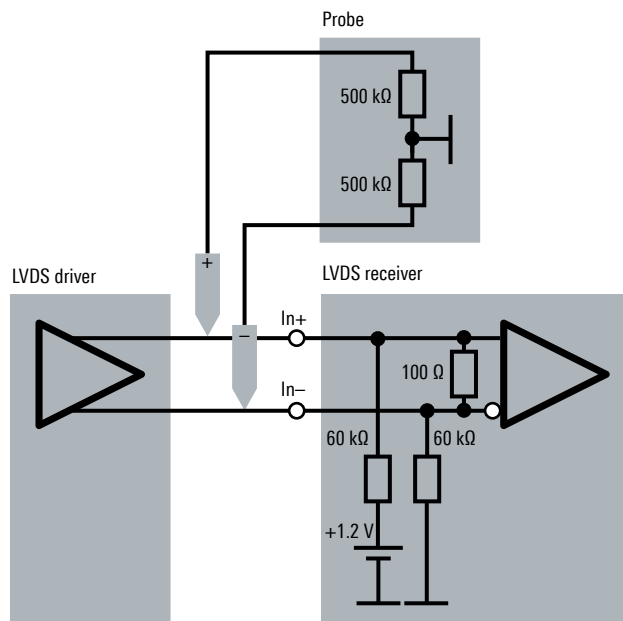

High common mode rejection

Differential signals are used especially at high clock rates to effectively suppress common mode interference and to transmit broadband signals without errors. These signals can be measured accurately only by using differential probes. Common mode rejection is an important quality parameter. Rohde & Schwarz differential probes suppress common mode interference over the entire probe bandwidth.

Low loading at DC and high frequencies

In the case of DC voltage, a distinction must be made between the input impedance for differential and common mode signals. This is particularly important when measuring low voltage differential signaling (LVDS) lines, for example. Although the differential input impedance of LVDS receivers is typically 100 Ω, the operating point is often set at high impedance. Excessive loading on the signal line can shift the operating point outside of the receiver's input voltage range and impair the functioning of the circuit. Almost all Rohde & Schwarz differential probes have a very high differential input impedance of 1 MΩ and a common mode impedance of 250 kΩ, ensuring that the loading remains low.

Compact R&S®RT-ZD40 active broadband probe

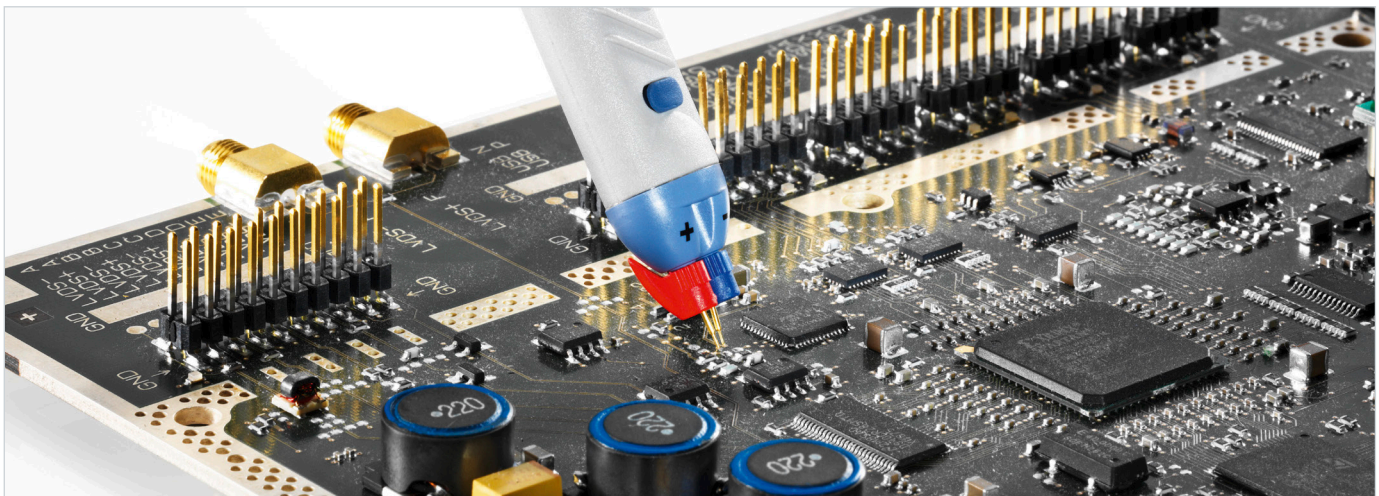

High common mode rejection over the entire probe bandwidth; here the R&S®RT-ZD40

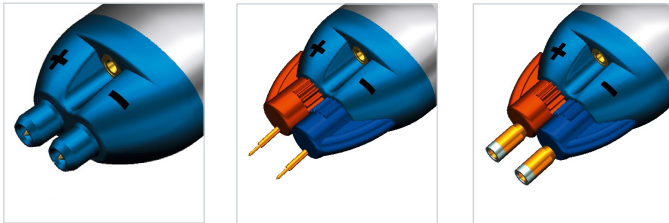
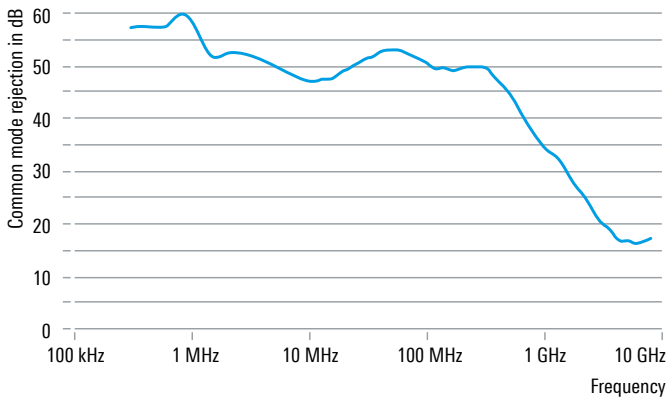

R&S®RT-ZD40: browser adapters to easily vary the pin offset

Wide dynamic range expands the range of applications

The wide dynamic range of ± 5 V with an additional off-set compensation of ± 5 V (differential mode) and ± 22 V¹⁾ (common mode) of the R&S®RT-ZD10/20/30/40 differential broadband probes make them universal measurement tools. High-speed, single-ended signals at DDR storage ports are just as easily measured as symmetrically fed RF signals or voltages without reference to ground in switching power supplies.

The R&S®RT-ZD10 active differential probe, together with the included R&S®RT-ZA15 external attenuator, permits the measurement of voltages up to ± 60 V DC/ ± 42.4 V AC (peak) at a bandwidth of 1 GHz.

Focus on usability

When designing the probe accessories, Rohde&Schwarz paid particular attention to usability. Clear identification of the positive and negative inputs, an extensive array of probe tips, easy and precisely adjustable pin offset and spring-loaded tips for the browser adapters are only a few of the special features.

¹⁾ This option is available for the R&S®RT-ZD20/30/40 starting with serial number 200000.



R&S®RT-ZA15 external attenuator for R&S®RT-ZD20/-ZD30

Model	Bandwidth	Attenuation factor	Input impedance	Dynamic range	Comment	Order No.
Probes						
R&S®RT-ZD10	1 GHz	10:1/ 100:1 ¹⁾	1 M Ω 0.6 pF/ 1 M Ω 1.3 pF ¹⁾	± 5 V, with R&S®RT-ZA15: ± 60 V DC ± 42.4 V AC (peak); offset compensation: ± 5 V (differential mode), ± 22 V ¹⁾ (common mode)	R&S®ProbeMeter and micro button for instrument control; R&S®RT-ZA15 included with R&S®RT-ZD10; Rohde&Schwarz probe interface	1410.4715.02
R&S®RT-ZD20	1.5 GHz	10:1	1 M Ω 0.6 pF			1410.4409.02
R&S®RT-ZD30	3.0 GHz	10:1	1 M Ω 0.6 pF			1410.4609.02
R&S®RT-ZD40	4.5 GHz		1 M Ω 0.4 pF	± 5 V		1410.5205.02
Accessories						
R&S®RT-ZA4					mini clips	1416.0428.02
R&S®RT-ZA5					micro clips	1416.0434.02
R&S®RT-ZA6					lead set	1416.0440.02
R&S®RT-ZA7					pin set for R&S®RT-ZD10/20/30	1417.0609.02
R&S®RT-ZA8					pin set for R&S®RT-ZD40	1417.0867.02
R&S®RT-ZA15	2 GHz	10:1	1 M Ω 1.3 pF	± 60 V DC/ ± 42.4 V AC (peak)	external attenuator for R&S®RT-ZD20/30; included with R&S®RT-ZD10	1410.4744.02

¹⁾ With R&S®RT-ZA15.

MODULAR BROADBAND PROBES

Addressing high-speed probing challenges

The R&S®RT-ZM modular probe system addresses today's probing requirements with a technically sophisticated yet easy-to-handle solution. The various probing solutions meet the demands for high probing bandwidth and dynamic range in conjunction with the need for low capacitive load. Examples include semi-permanent solder-in probe tips for physically small probing areas or a solution for environmental tests in climatic chambers at temperatures from -55°C to $+125^{\circ}\text{C}$.

The R&S®RT-ZM modular probe system delivers high performance in combination with flexible and configurable connectivity. The system includes probe tip modules for various measurement tasks and conditions. These modules can be connected to amplifier modules with bandwidths ranging from 1.5 GHz to 16 GHz. The modular probe system also offers multimode functionality, enabling users to switch between different measurement modes. The integrated R&S®ProbeMeter functionality makes it possible to perform high-precision DC voltage measurements at the same time.

R&S®RT-ZM probe amplifier modules

The R&S®RT-ZM modular probe system is available with amplifier modules offering bandwidths from 1.5 GHz to 16 GHz. These modules come with a Rohde&Schwarz probe interface that allows automatic probe detection and configuration on Rohde&Schwarz oscilloscopes. The amplifier is equipped with a miniaturized high-quality and high-frequency coaxial double-socket SMP connector for flexible snap-on use with various probe tips modules (see figure on next page).

The SMP connector on the amplifier is specially designed for a bandwidth from DC to 26.5 GHz. It offers minimum return loss and ensures high repeatability for many connect/disconnect cycles. The double-socket SMP connector has built-in connector alignment to safeguard the connection between the probe amplifier module and the probe tip modules to provide highly repeatable signal transmission conditions.

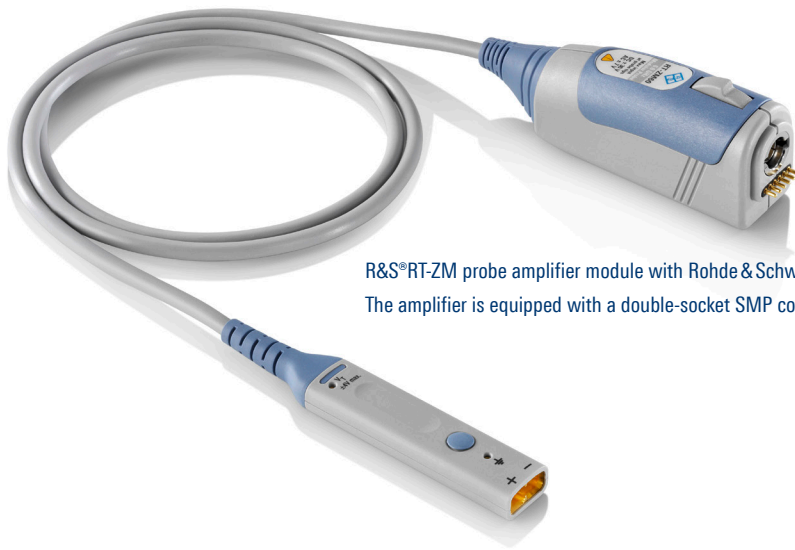

R&S®RT-ZM probe amplifier module with Rohde & Schwarz probe interface
The amplifier is equipped with a double-socket SMP connector.

R&S®RT-ZM modular probe system with exchangeable R&S®RT-ZM probe tip module

(connected via a high-performance double-socket SMP snap-on interface to an R&S®RT-ZM probe amplifier module with Rohde & Schwarz probe interface)

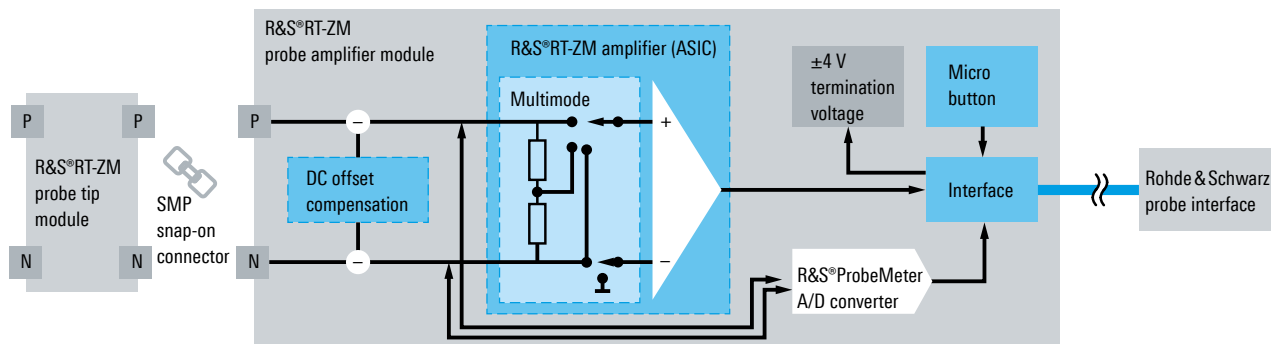

Probe tip modules for the R&S®RT-ZM

► For detailed information, see R&S®RT-ZM flyer PD 3607.5690.32

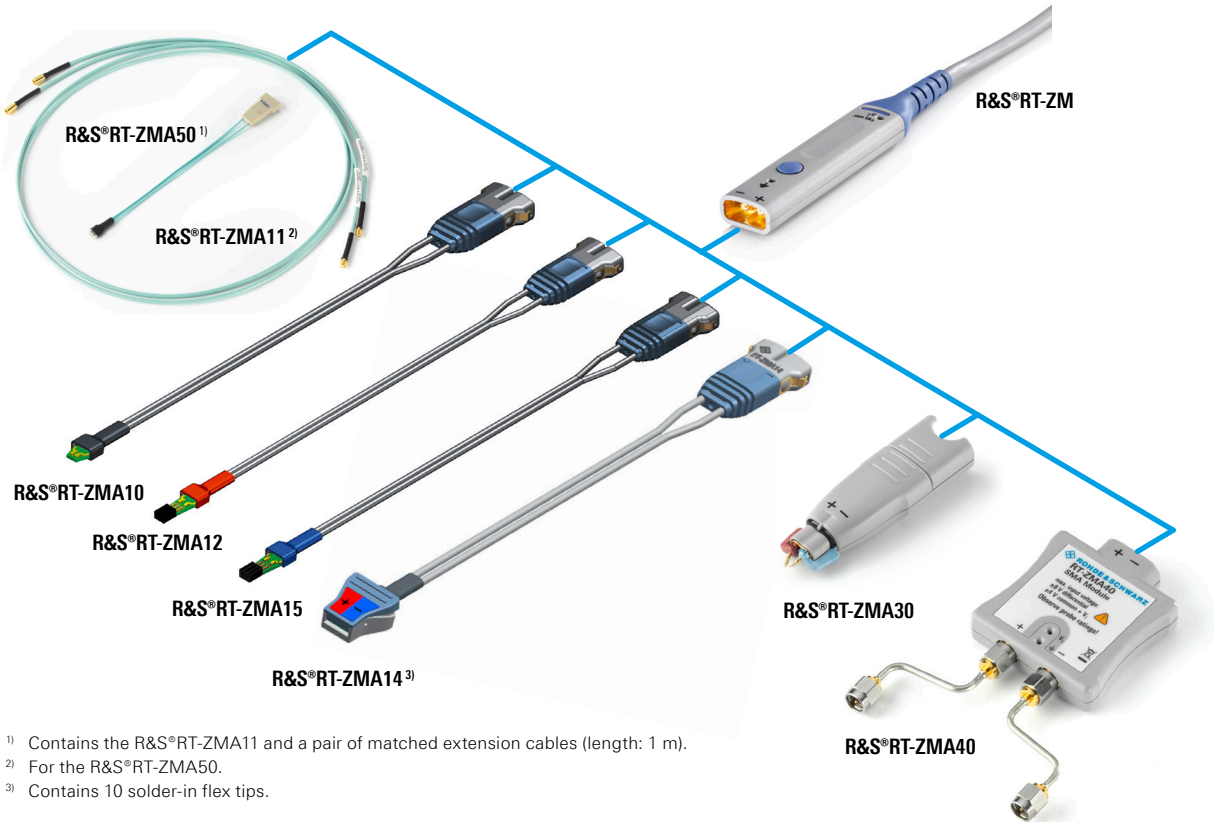

¹⁾ Contains the R&S®RT-ZMA11 and a pair of matched extension cables (length: 1 m).

²⁾ For the R&S®RT-ZMA50.

³⁾ Contains 10 solder-in flex tips.

Model	System bandwidth	Rise time (10% to 90%)	Multimode ¹⁾	Comment	Order No.
Probe amplifier modules					
R&S®RT-ZM15	> 1.5 GHz	< 230 ps			1800.4700.02
R&S®RT-ZM30	> 3 GHz	< 100 ps			1419.3005.02
R&S®RT-ZM60	> 6 GHz	< 75 ps			1419.3105.02
R&S®RT-ZM90	> 9 GHz	< 50 ps			1419.3205.02
R&S®RT-ZM130	> 13 GHz	< 35 ps			1800.4500.02
R&S®RT-ZM160	16 GHz	< 28 ps			1800.4600.02
Probe tip modules					
R&S®RT-ZMA10	16 GHz (meas.)	28 ps	P/N/DM/CM	length: 15 cm (5.9 in), suitable for R&S®RT-ZMA50	1419.4301.02
R&S®RT-ZMA10-6				set of 6 R&S®RT-ZMA10 solder-in probe tip modules	1801.4349.02
R&S®RT-ZMA11	16 GHz (meas.)	28 ps	P/N/DM/CM	length: 15 cm (5.9 in)	1419.4318.02
R&S®RT-ZMA12	6 GHz (meas.)	75 ps	P/N/DM/CM	length: 15 cm (5.9 in)	1419.4324.02
R&S®RT-ZMA14	16 GHz (meas.)	28 ps	P/N/DM/CM	length: 15 cm (5.9 in), incl. 10 solder-in flex tips	1338.1010.02
R&S®RT-ZMA15	12 GHz (meas.)	37 ps	P/N/DM/CM	length: 15 cm (5.9 in)	1419.4224.02
R&S®RT-ZMA30	16 GHz (meas.)	28 ps	DM		1419.4353.02
R&S®RT-ZMA40	16 GHz (meas.)	28 ps	P/N/DM/CM	50 Ω/100 Ω, suitable for SMA, 3.5 mm and 2.92 mm systems, termination voltage ±4 V, supplied from R&S®RT-ZM probe amplifier module	1419.4201.02
R&S®RT-ZMA50	12 GHz (meas.)	37 ps	P/N/DM/CM	cable length: 1 m (39.37 in); consists of R&S®RT-ZMA11 and a pair of matched extension cables, temperature range: -55°C to +125°C	1419.4218.02
Accessories					
R&S®RT-ZMA1				for up to 6 R&S®RT-ZMAxx probe tip modules	1419.3928.02
R&S®RT-ZAP				3D probe positioner	1326.3641.02
R&S®RT-ZF30				test fixture for probe characterization with R&S®RTP-B7	1333.2099.02

¹⁾ Multimode:

DM: differential measurement, CM: common mode measurement, P: single-ended measurement on positive pin, N: single-ended measurement on negative pin.

POWER RAIL PROBE

High bandwidth, high sensitivity, very low noise and an extra-large offset compensation make the R&S®RT-ZPR power rail probes an excellent tool for characterizing power rails. An integrated high-accuracy DC voltmeter provides instantaneous DC voltage readout.

Up to 4.0 GHz bandwidth and very low added noise

Low voltages with tight tolerances make testing power rails difficult. Not only do newer power rails require more precise low voltage measurements, the rails are susceptible to coupling from high-speed clocks and RF sources.

With a bandwidth up to 4.0 GHz, excellent sensitivity due to the 1:1 attenuation ratio and low noise, the R&S®RT-ZPR power rail probes excel at precise ripple measurements. Coupled with the industry's best spectrum analysis capabilities of the R&S®RTO and R&S®RTE oscilloscopes, the solution also helps users isolate periodic and random disturbances (PARD).

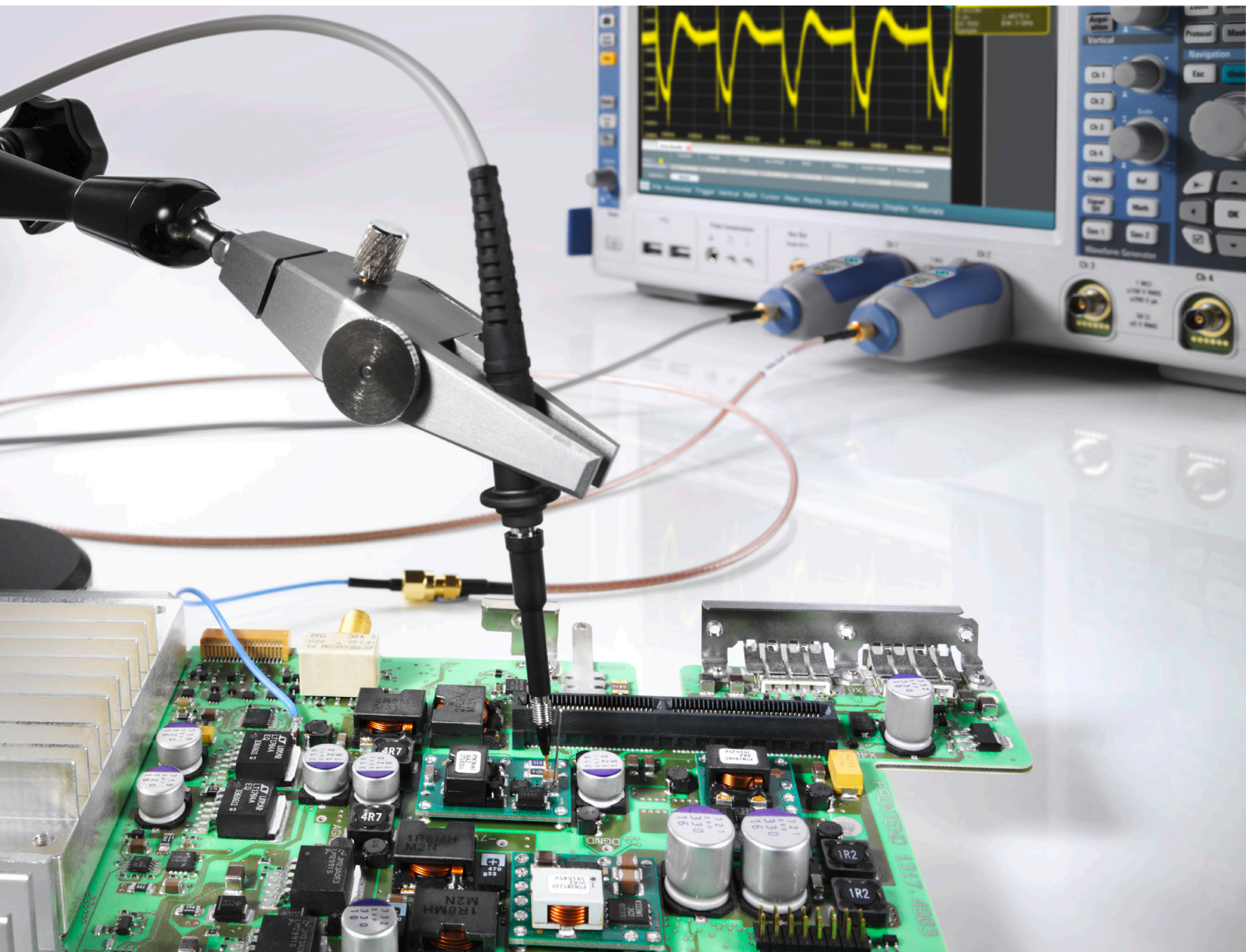

Measuring small voltages riding on large DC offsets

The oscilloscopes' built-in offset is typically not sufficient to zoom in and to accurately measure peak-to-peak voltage on DC power rails. This makes accurate ripple measurements impossible. With ± 60 V offset compensation range, the R&S®RT-ZPR power rail probes allow users to zoom in on DC voltages with high offset. Whether you need to zoom in on a 1 V power rail or something much higher, the probe provides the needed offset.

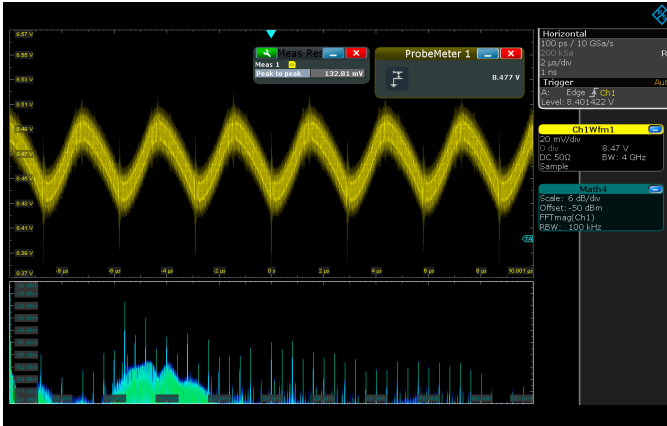

The high bandwidth of the R&S®RT-ZPR power rail probes allow you to capture even high-frequency noise components that can be easily analyzed with the R&S®RTO spectrum analysis function.

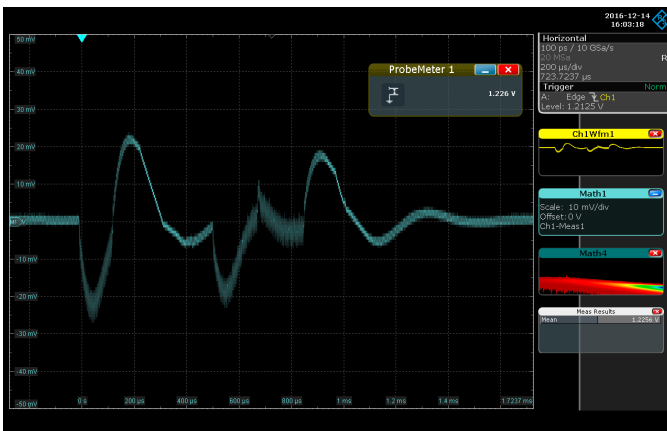

Accurately verify DC level and power supply load response during initialization of a DDR3 memory with the R&S®ProbeMeter and the R&S®RTO oscilloscope's flexible math functions.

R&S®ProbeMeter: integrated high-accuracy DC voltmeter

While other oscilloscopes are limited to showing a waveform view of power rails under test, the R&S®RT-ZPR power rail probes additionally incorporate a high-accuracy DC voltmeter to quickly see rail values. The integrated DC voltmeter with an input voltage range of ± 60 V monitors long-term drift of the DC level with high accuracy. Combined with the ripple voltage observed at the oscilloscope, you can see at any time whether the power supply ripple leaves the permitted operating voltage window of the DUT.

Comprehensive accessories included

The R&S®RT-ZPR power rail probes come with solder-in cables for broadband probing and a 350 MHz browser kit to easily measure at different places on a PCB or to verify the DC power supply using the R&S®ProbeMeter.

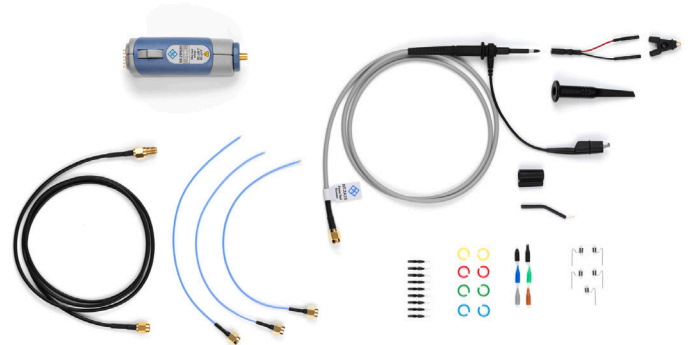

The R&S®RT-ZPR power rail probes come with a rich set of standard accessories for probing in all scenarios.

Model	Bandwidth	Attenuation factor	Input impedance	Dynamic range	Comment	Order No.
R&S®RT-ZPR20	2.0 GHz	1:1	50 k Ω	± 0.85 V	R&S®ProbeMeter	1800.5006.02
R&S®RT-ZPR40	4.0 GHz	1:1	50 k Ω	± 60 V offset compensation), optional AC coupling	R&S®ProbeMeter	1800.5406.02
R&S®RT-ZA25	–	–	–	–	power rail browser kit, included with R&S®RT-ZPR20/40	1800.5329.00
R&S®RT-ZA26	–	–	–	–	pigtail cable, 15 cm, solder-in, SMA for R&S®RT-ZPR20/40 power rail probe, included with R&S®RT-ZPR20/40	1800.5258.00

MULTI-CHANNEL POWER PROBE

Power consumption is a major concern in the internet of things (IoT) world and for a lot of consumer electronics devices. The R&S®RT-ZVC multi-channel power probe offers up to four voltage and four current channels with 18-bit resolution for high dynamic range current and voltage measurements. With up to two R&S®RT-ZVC probes supported on a single R&S®RTE, R&S®RTO or R&S®RTP oscilloscope, it is possible to analyze eight high dynamic range voltage signals and eight high dynamic range current signals in parallel with signals captured by the oscilloscope.

To optimize the battery life of embedded devices, the device's active, sleep and hibernate current consumption needs to be balanced. While active current consumption can reach levels of tens or hundreds of mA, sleep currents are often as low as several μA , but they still significantly influence battery life since devices are in sleep mode most of the time.

Very high dynamic range with 18-bit ADC resolution

With up to four current and four voltage input channels, each with 18-bit ADC resolution, the R&S®RT-ZVC02/-ZVC04 multi-channel power probe provides the dynamic range needed to analyze current consumption in all mobile device activity phases.

Internal and external shunt current measurement with switchable sensitivity

Three built-in shunts and an external shunt mode in combination with switchable gain factors lets you optimize the input current range. Differential inputs provide floating measurements within an input voltage operating window of $\pm 15\text{ V}$. Settings are fully controlled from the oscilloscope user interface.

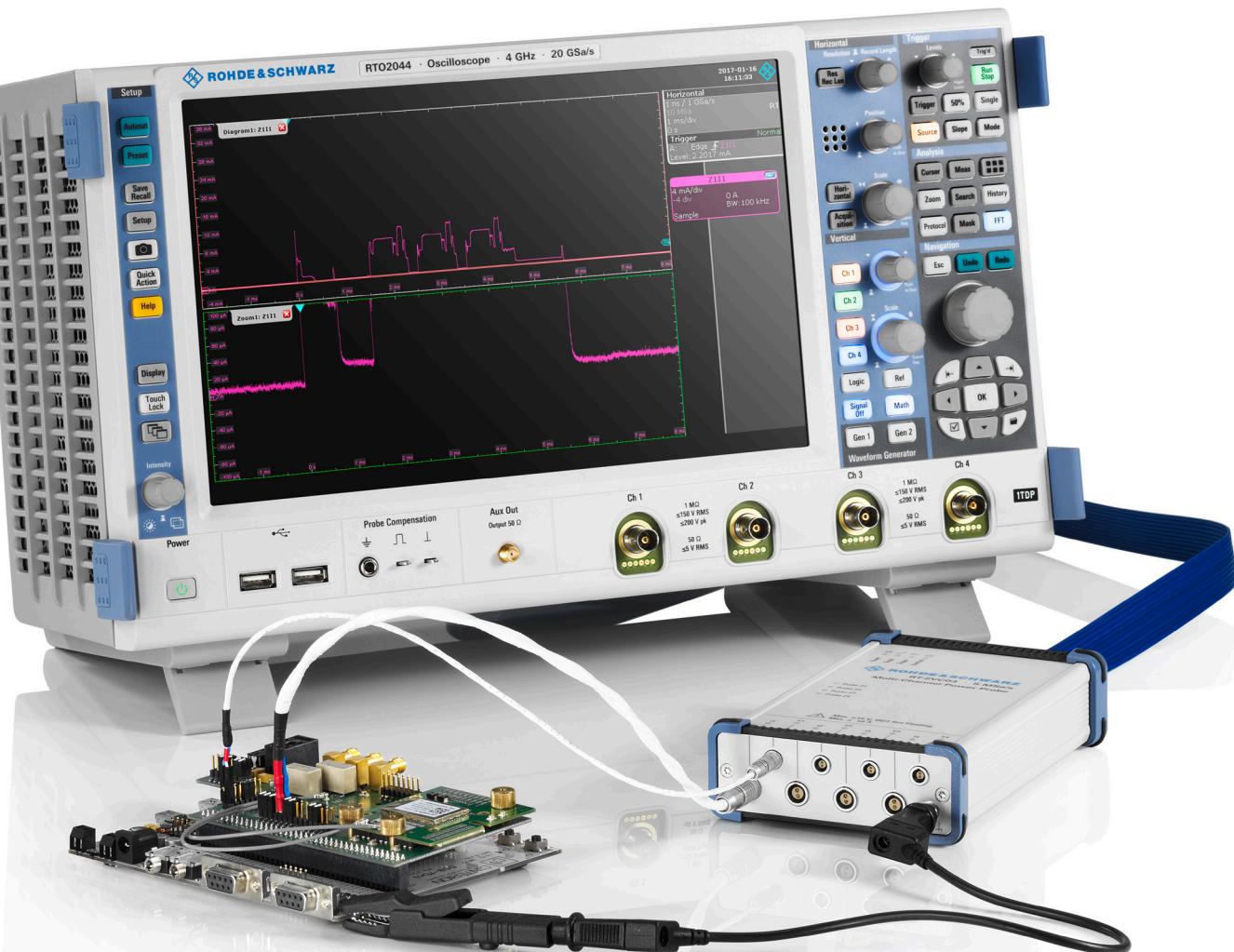

High bandwidth with flexible filtering for noise reduction

A bandwidth of 1 MHz and a sampling rate of 5 Msample/s allows you to capture fast current pulses. To analyze the overall power consumption of battery powered devices, the very low sleep mode currents have to be captured at the same time. For very high dynamic range measurements, the integrated lowpass filter reduces the bandwidth down to 5 kHz and minimizes overall system noise.

Measure up to eight power rails at the same time with highest accuracy

One R&S®RTE, R&S®RTO or R&S®RTP oscilloscope supports up to two R&S®RT-ZVC current probes so that it is possible to observe eight power domains in parallel with a DC accuracy of 0.1 % for voltage measurements and 0.2% for current measurements. Ramp-up processes and power rail tolerances can easily be tested with this probe. The oscilloscope's SCPI remote control enables automatic testing.

Digital acquisition system

The R&S®RT-ZVC probe's digital acquisition system provides 18-bit resolution, a 5 Msample/s sampling rate and 1 MHz bandwidth. Each voltage and current input pair forms a high dynamic range power measurement system.

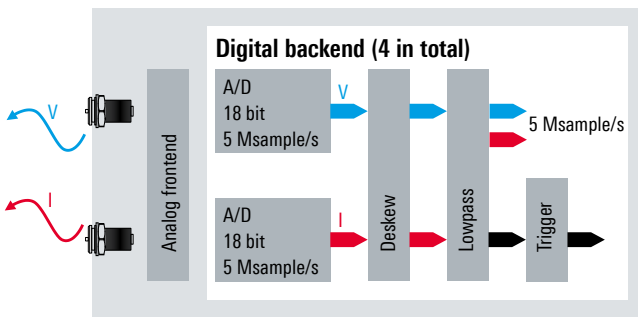

Current ranges

Low-gain mode, shunt

- ▶ $\pm 4.5 \mu\text{A}$; $\pm 45 \mu\text{A}$, $10 \text{ k}\Omega$
- ▶ $\pm 4.5 \text{ mA}$; $\pm 45 \text{ mA}$, 10Ω
- ▶ $\pm 4.5 \text{ A}$; $\pm 10 \text{ A}$, $10 \text{ m}\Omega$
- ▶ $\pm 45 \text{ mV}^{1)}$; $\pm 450 \text{ mV}^{1)}$, external

Voltage ranges

- ▶ $\pm 1.88 \text{ V}$
- ▶ $\pm 3.75 \text{ V}$
- ▶ $\pm 7.5 \text{ V}$
- ▶ $\pm 15 \text{ V}$

¹⁾ Current range depends on shunt value.

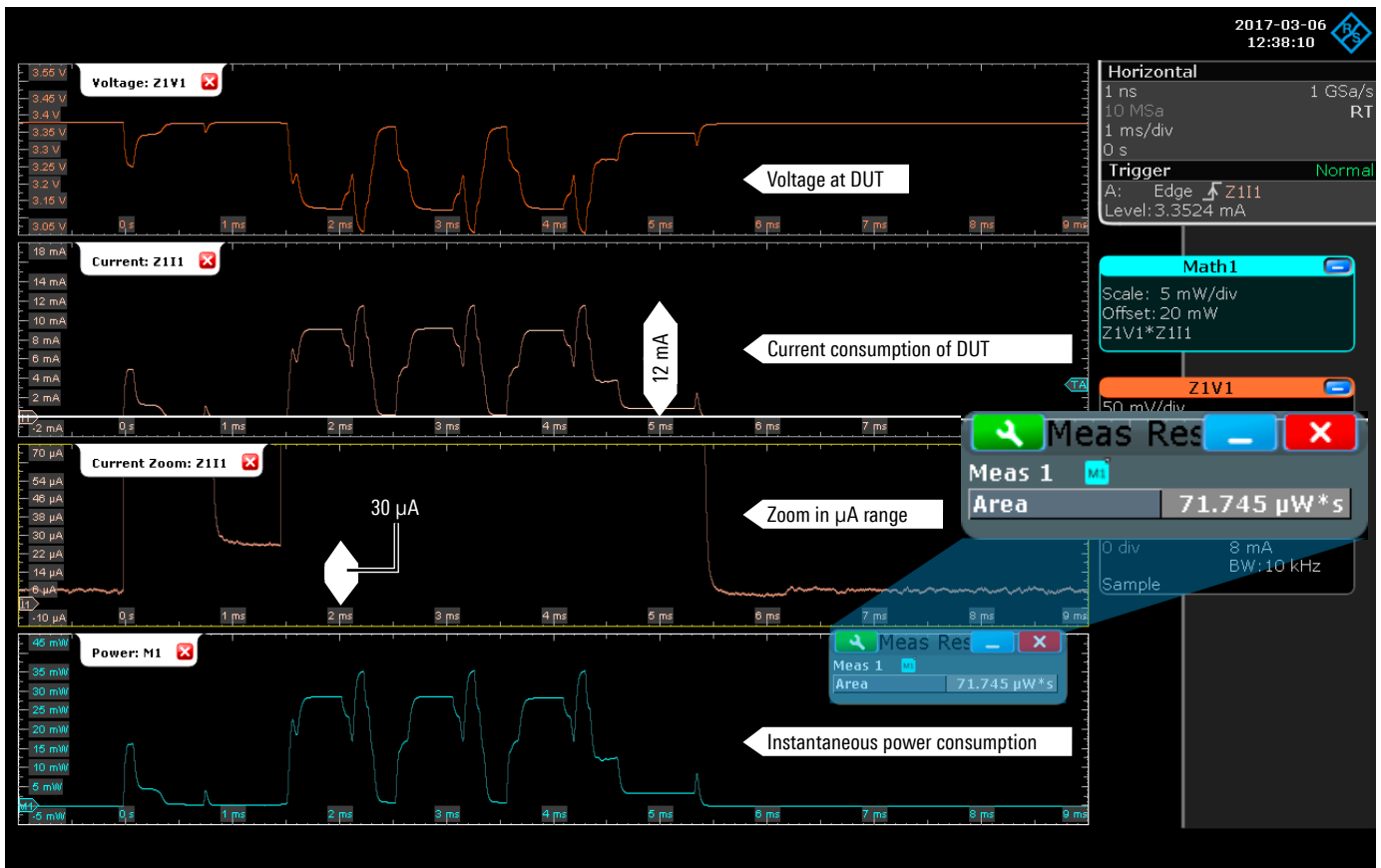

The R&S®RT-ZVC probe provides an extraordinarily high dynamic range for measuring both active state currents and sleep currents, in this example 12 mA and 30 μA . Automated measurements make it possible to calculate the total energy consumption.

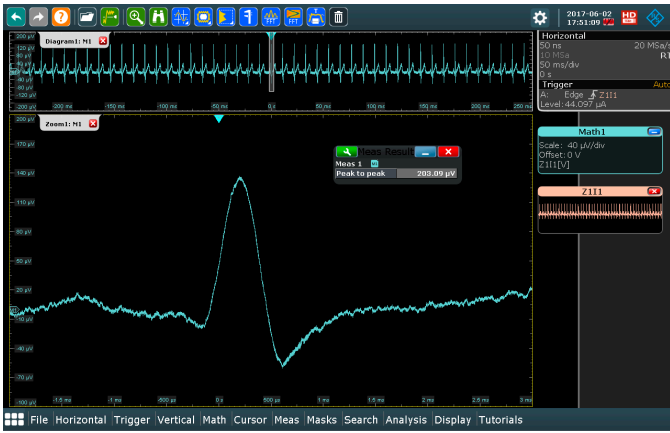

Small signals such as a 200 µV cardiac pulse can easily be measured.

Very low-noise frontend for measuring sensor signals

The extraordinarily high dynamic range and low-noise design of the R&S®RT-ZVC probe enables clear measurement of small sensor signals. Maximum sensitivity can be achieved by using the current inputs in external shunt mode which results in 18-bit resolution at 45 mV full-scale differential input voltage. A cardiac voltage pulse with a signal level of only 200 µV (peak-to-peak) can easily be captured and analyzed.

Flexible connectivity options for every application

The R&S®RT-ZVC multi-channel power probe comes with a set of high-quality pin connector cables and solder-in leads to connect the probe in typical embedded electronics measurement scenarios. 4 mm connector cables with different lengths are optionally available as are BNC type connector cables for connecting standard oscilloscope voltage and current probes to extend the voltage and current measurement range.



Standard accessories include PCB connector cables for each channel and solder-in leads.



4 mm cables with different lengths and BNC connector cables are optionally available.

Model	Input channels	Bandwidth/sampling rate	Resolution	Input impedance	Full-scale input range	Common mode input voltage range	Order No.
R&S®RT-ZVC02	2 current, 2 voltage	1 MHz/ 5 Msample/s	18 bit			±15 V	1326.0259.02
R&S®RT-ZVC04	4 current, 4 voltage	1 MHz/ 5 Msample/s	18 bit	<ul style="list-style-type: none"> ▶ Voltage channels: 10 MΩ 48 pF ▶ Current channels: 1 MΩ shunt resistor 	<ul style="list-style-type: none"> ▶ Voltage ±1.88 V/±3.75 V/±7.5 V/±15 V ▶ Current (internal shunt) 10 kΩ: ±4.5 μA, ±45 μA, 10 Ω: ±4.5 m, ±45 mA, 10 mΩ: ±4.5 A, ±10 A ▶ Current (external shunt, voltage range) ±45 mV, ±450 mV (all channels) 	±15 V	1326.0259.04

Accessories	Comment	Order No.
R&S®RT-ZA30	Extended cable set for R&S®RT-ZVC, PCB probing, 1 current and 1 voltage lead, length: 32 cm	1333.1686.02
R&S®RT-ZA31	Extended cable set for R&S®RT-ZVC, 4 mm probing, 1 current and 1 voltage lead, length: 32 cm	1333.1692.02
R&S®RT-ZA33	Oscilloscope interface cable for R&S®RT-ZVC (included with R&S®RT-ZVC02/-ZVC04, 1326.0259.02/.04)	1333.1770.02
R&S®RT-ZA34	Extended cable set for R&S®RT-ZVC, 4 mm probing, 1 current and 1 voltage lead, length: 1 m	1333.1892.02
R&S®RT-ZA35	Extended cable set for R&S®RT-ZVC, PCB probing, 1 current and 1 voltage lead, length: 1 m	1333.1905.02
R&S®RT-ZA36	Solder-in cable set for R&S®RT-ZVC, 4 current and voltage solder-in cables, solder-in pins	1333.1911.02
R&S®RT-ZA37	Extended cable set for R&S®RT-ZVC, BNC connector, 1 current and 1 voltage lead, length: 16 cm	1337.9130.02
R&S®RTE-B1E	Digital extension port for R&S®RT-ZVC usage with the R&S®RTE oscilloscope (included with R&S®RTE-B1)	1333.0750.02
R&S®RTO-B1E	Digital extension port for R&S®RT-ZVC usage with the R&S®RTO oscilloscope (included with R&S®RTO-B1)	1333.0738.02
R&S®RTP-B1E	Digital extension port for R&S®RT-ZVC usage with the R&S®RTP oscilloscope (included with R&S®RTP-B1)	1337.9581.02

HIGH VOLTAGE PROBES

The Rohde & Schwarz portfolio of high voltage probes includes passive single-ended and active differential probes for voltages up to 6000 V (peak). Different models allow measurements up to CAT IV environments. Differential probes provide an exceptional common mode rejection ratio over a broad frequency range.

200 MHz bandwidth combined with excellent common mode rejection ratio

In order to achieve highest power efficiencies and power densities in switched-mode power supplies, switching loss has to be minimized. This requires the use of modern, fast-switching semiconductors.

With up to 200 MHz bandwidth and an excellent common mode rejection ratio (CMRR) over a broad frequency range, the R&S®RT-ZHD high voltage differential probes are ideal for measurements on fast-switching semiconductors. Extraordinarily low added noise results in high-quality measurements.

Measurements with highest precision

With 0.5% ensured gain accuracy in the signal path and a DC voltmeter (R&S®ProbeMeter) with 0.1% accuracy integrated into the probe head, the R&S®RT-ZHD probes provide the best available precision in their class. Very low drift makes regular calibration during measurements unnecessary.

The R&S®RT-ZHD high voltage differential probes can be used to safely measure peak voltages up to 6000 V. Excellent common mode rejection ratio, a bandwidth of up to 200 MHz and an integrated DC voltmeter are some of their highlights.

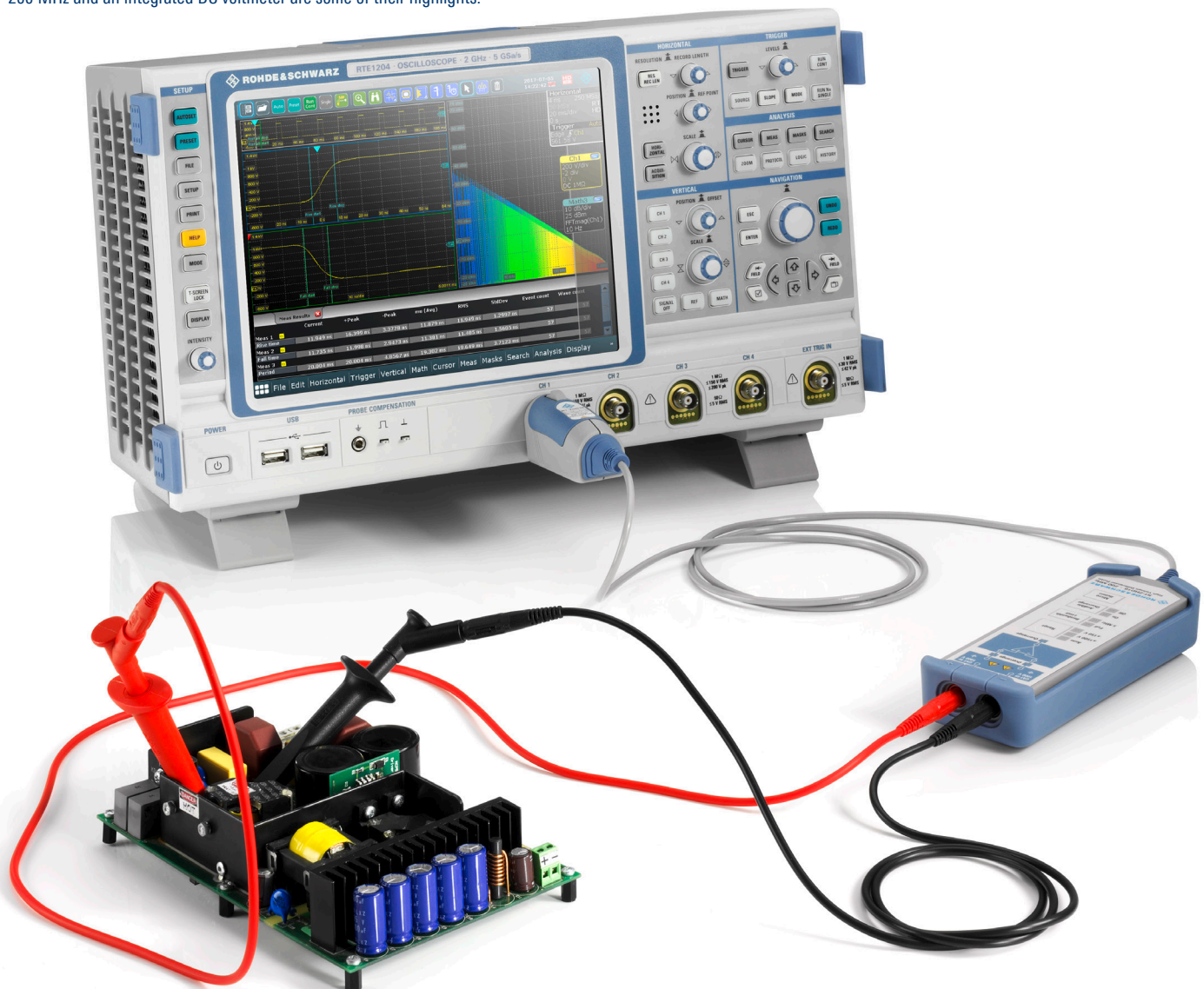

Up to 2000 V offset capability at highest vertical sensitivity

To measure ripple voltages on the DC link, it is necessary to compensate for high offset voltages and measure with high vertical sensitivities. Due to its integrated offset circuit, the R&S®RT-ZHD probes offer an offset voltage range that is independent of the vertical setting of the oscilloscope and the attenuation factor on the probe. Now you can measure the smallest of ripple voltages on large DC link voltages without compromising sensitivity.

Easy to use and fully integrated into the Rohde & Schwarz oscilloscopes

An integrated, switchable, 5 MHz analog filter, an audible overrange indicator that indicates common mode voltage overrange situations, and automatic range switching make the probe easy to use. The integrated micro button allows you to control the oscilloscope from the probe.

Fully integrated into the oscilloscope, the probe can be remote controlled for automatic testing and does not require an external power supply.

BNC-type differential probes for less demanding applications

For applications where bandwidth is not critical and a cost-effective solution is required, the R&S®RT-ZD01 high voltage differential probe is an excellent choice. It offers 100 MHz bandwidth for voltages up to 1400 V (peak). Due to the BNC interface, it can be connected to any oscilloscope. Power is supplied via the oscilloscope's USB port or batteries.

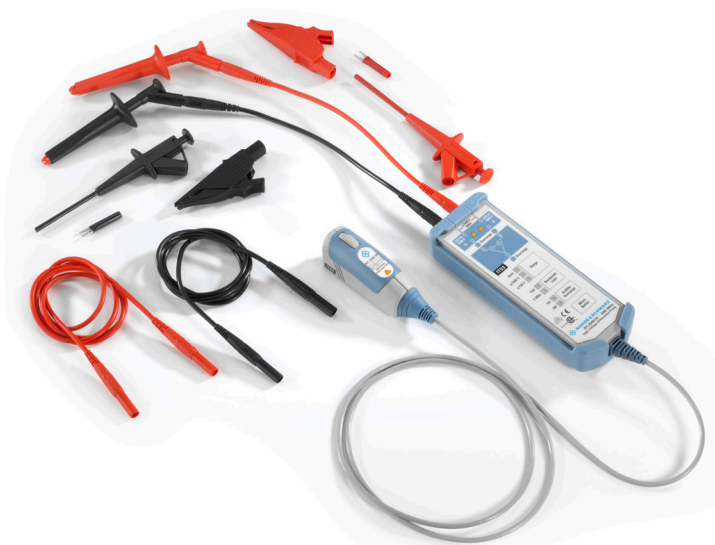

Rich set of standard accessories for the R&S®RT-ZHD high voltage differential probes



The R&S®RT-ZD01 high voltage differential probe provides 100 MHz bandwidth for up to 1400 V input voltage. Its BNC interface makes this probe ideal for the R&S®RTB2000.

Maximum pulse peak voltage as a function of the RMS voltage

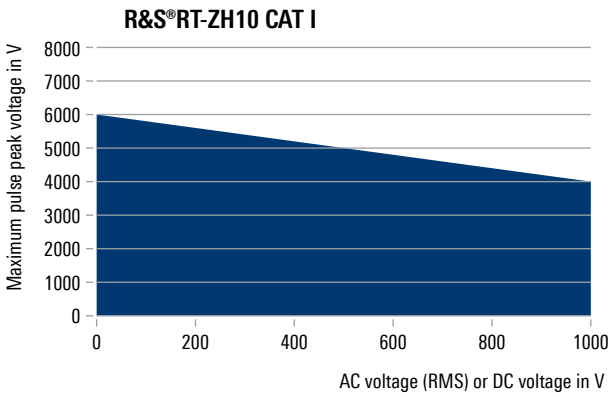

Single-ended passive probes for voltages up to 1000 V (RMS) and 6000 V (peak)

If differential measurements are not required, single-ended passive probes are a powerful, cost-effective solution. The R&S®RT-ZH10 and R&S®RT-ZH11 passive high voltage probes provide a bandwidth up to 400 MHz and attenuation factors of 100:1 and 1000:1, respectively.

Both probes are designed for RMS voltages up to 1000 V (CAT II) and – when used exclusively for pulse measurements – for peak voltages up to 6000 V (CAT I). Accessories include safety alligator clips, rigid and spring-loaded tips and protection caps.



The R&S®RT-ZH03 passive high voltage probe has a robust 5 mm probe tip and is the perfect choice if 250 MHz bandwidth is sufficient.



The R&S®RT-ZH10 and R&S®RT-ZH11 passive high voltage probes provide 400 MHz bandwidth and a spring-loaded 5 mm tip.

Overview of measurement categories CAT 1 through CAT IV

The probe design determines its area of application and the maximum rated voltage against protective ground.

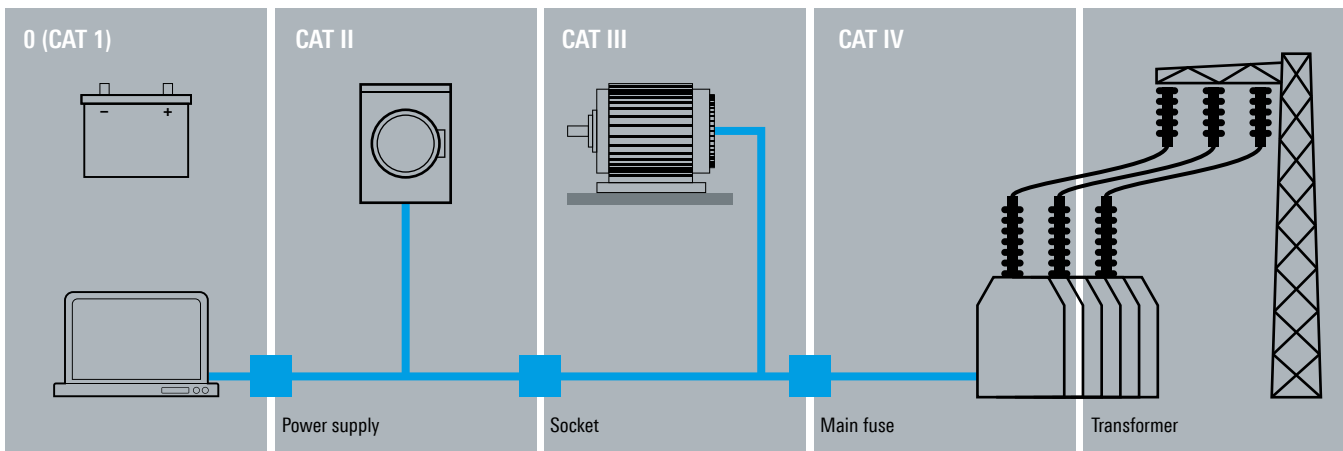

Measuring voltages up to 1000 V (RMS) with 500 MHz bandwidth

Measuring in high voltage environments requires special safety precautions in line with the European Low Voltage Directive that depend on the actual measurement environment.

The R&S®ScopeRider RTH lets you safely measure voltages up to 1000 V in CAT III environments or 600 V in CAT IV environments. In combination with the R&S®RT-ZI11 100:1 passive high voltage probe, a bandwidth of 500 MHz is achieved. This makes the solution interesting for measurements on GaN based power electronics components.

With a 500 MHz bandwidth, the R&S®RT-ZI11 passive probes can be used to measure fast switching edges of GaN power electronics designs. Designed for the R&S®ScopeRider RTH oscilloscope with its isolated channels, the probes are ideal for floating measurements of voltages with common mode voltages up to 1000 V (RMS).

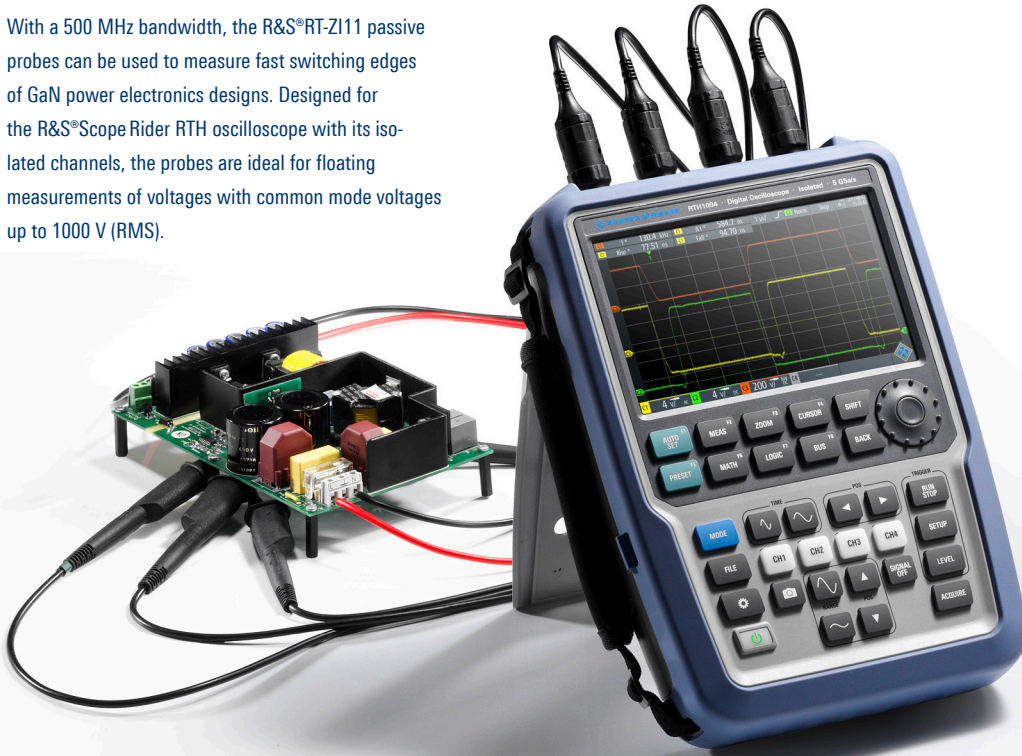

Model	Bandwidth	Attenuation factor	Input impedance	Dynamic range	Comment	Order No.
Passive						
R&S®RT-ZH03	250 MHz	100:1	100 M Ω 6.5 pF	850 V (RMS)	robust 5 mm probe tip	1333.0873.02
R&S®RT-ZH10	400 MHz	100:1	50 M Ω 7.5 pF	1000 V (RMS), 6000 V (peak)	1000 V (RMS) CAT II, 5 mm probe tip, spring-loaded	1409.7720.02
R&S®RT-ZH11	400 MHz	1000:1	50 M Ω 7.5 pF	1000 V (RMS), 6000 V (peak)	1000 V (RMS) CAT II, 5 mm probe tip, spring-loaded	1409.7737.02
R&S®RT-ZI11	500 MHz	100:1	100 M Ω 4.6 pF	1000 V (RMS)	600 V (RMS) CAT IV, 1000 V (RMS) CAT III, 3540 V (RMS) CAT 0, for R&S®ScopeRider RTH only	1326.1810.02
Active, differential						
R&S®RT-ZD01	100 MHz	100:1/1000:1	8 M Ω 3.5 pF	\pm 1400 V	1000 V (RMS) CAT III	1422.0703.02
R&S®RT-ZHD07	200 MHz	25:1/250:1	5 M Ω 2.5 pF	\pm 750 V	300 V (RMS) CAT III	1800.2307.02
R&S®RT-ZHD15	100 MHz	50:1/500:1	10 M Ω 2 pF	\pm 1500 V	1000 V (RMS) CAT III	1800.2107.02
R&S®RT-ZHD16	200 MHz	50:1/500:1	10 M Ω 2 pF	\pm 1500 V	1000 V (RMS) CAT III	1800.2207.02
R&S®RT-ZHD60	100 MHz	100:1/1000:1	40 M Ω 2 pF	\pm 6000 V	1000 V (RMS) CAT III	1800.2007.02
Accessory						
R&S®RT-ZA24					replacement kit for R&S®RT-ZHD probes	1800.2707.00

CURRENT PROBES

Rohde & Schwarz current probes enable accurate, non-intrusive measurement of DC and AC currents. Different models are available to measure currents in the range of 1 mA to 2000 A with a maximum bandwidth of up to 120 MHz.

DC and AC measurements without circuit interruption

The R&S®RT-ZC current probes precisely measure direct and alternating current without interrupting the power circuit for the measurement. The extra-large opening on the R&S®RT-ZC10 accommodates conductors of up to 20 mm in diameter. The R&S®RT-ZC10 can measure peak currents up to 300 A (500 A for a single pulse). When measuring low-amplitude, high-frequency currents, the more compact R&S®RT-ZC20 with a measurement bandwidth of 100 MHz is ideal.

The R&S®RT-ZC31 allows switching between three different sensitivity ranges to cover a very broad dynamic range with high bandwidth.

Robust design and easy operation

Rohde & Schwarz current probes are characterized by their robust design and easy operation. The degauss and offset correction is performed directly at the probe connector. The compact R&S®RT-ZA13 probe power supply supplies up to four current probes. The current probes can be selected as predefined probes on the R&S®RTO, R&S®RTE, R&S®RTM and R&S®RTA oscilloscopes.

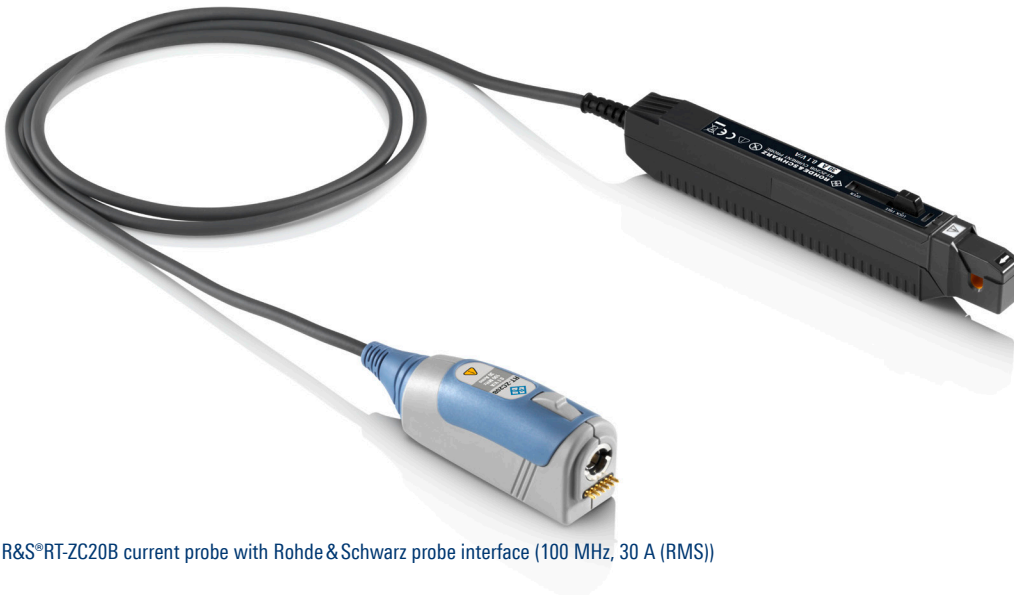

R&S®RT-ZC20B current probe with Rohde & Schwarz probe interface (100 MHz, 30 A (RMS))



External power supply for up to four current probes

Easy deskewing for simultaneous current and voltage measurements

For meaningful measurements on power electronics, there must be no time delay (skew) between the current and the voltage measurements. The R&S®RT-ZF20 power deskew and calibration test fixture provides a variety of test signals that can be used to easily compensate for skew between Rohde&Schwarz current and voltage probes. Power to the power deskew and calibration test fixture is supplied via the oscilloscope's USB port.



R&S®RT-ZF20 power deskew and calibration test fixture: easy deskewing for measurements on power electronics.

Model	Bandwidth	Sensitivity	Dynamic range	Rise time	Comment	Order No.
Probes						
R&S®RT-ZC02	20 kHz	0.01 V/A, 0.001 V/A	±200 A, ±2000 A	5 µs	battery powered	1333.0850.02
R&S®RT-ZC03	100 kHz	0.1 V/A	20 A (RMS), ±30 A (peak)	1 µs	battery powered	1333.0844.02
R&S®RT-ZC05B	2 MHz	0.01 V/A	500 A (RMS), 700 A (peak)	175 ns	power supply via Rohde&Schwarz probe interface	1409.8204.02
R&S®RT-ZC10	10 MHz	0.01 V/A	150 A (RMS), ±300 A (peak)	35 ns	power supply via R&S®RT-ZA13	1409.7750K02
R&S®RT-ZC10B	10 MHz	0.01 V/A	±500 A (peak) (single pulse)	35 ns	power supply via Rohde&Schwarz probe interface	1409.8210.02
R&S®RT-ZC15B	50 MHz	0.1 V/A		7 ns	power supply via Rohde&Schwarz probe interface	1409.8227.02
R&S®RT-ZC20	100 MHz	0.1 V/A	30 A (RMS), ±50 A (peak)	3.5 ns	power supply via R&S®RT-ZA13	1409.7766K02
R&S®RT-ZC20B	100 MHz	0.1 V/A		3.5 ns	power supply via Rohde&Schwarz probe interface	1409.8233.02
R&S®RT-ZC30	120 MHz	1 V/A	5 A (RMS), 7.5 A (peak)	2.9 ns	power supply via R&S®RT-ZA13	1409.7772K02
R&S®RT-ZC31	120 MHz	0.1 V/A, 1 V/A, 10 V/A	30 A (RMS), 5 A (RMS), 0.5 A (RMS)	2.9 ns	power supply via R&S®RT-ZA13	1801.4932K02
Accessories						
R&S®RT-ZF20					power deskew and calibration test fixture	1800.0004.02
R&S®RT-ZA13					external power supply for up to four Rohde&Schwarz current probes	1409.7789.02

EMC NEAR-FIELD PROBES

Powerful E and H near-field probes for the frequency range from 30 MHz to 3 GHz with optional preamplifier expand the application range of the R&S®RTO oscilloscopes to include EMI debugging.

R&S®RTO oscilloscope's powerful FFT analysis function

The R&S®RTO oscilloscope's powerful FFT function permits for the first time debugging of EMI problems using an oscilloscope. Developers now have a cost-effective solution for EMI debugging right on their lab bench. Unwanted EMI can be displayed simultaneously in both the time and frequency domain, speeding up debugging.

Versatile near-field probe sets

Near-field probes are used to analyze EMC problems in electronic circuits and to identify their causes. Rohde&Schwarz offers several near-field probe sets that include E-field and H-field probes for use with oscilloscopes, signal and spectrum analyzers and EMI test receivers.

The R&S®HZ-15 E and H near-field probe set consists of several passive near-field probes that are ideal for diagnosing EMC problems on printed boards. The compact design facilitates localization of EMI sources down to the individual conductors. The optional R&S®HZ-16 preamplifier offers 20 dB gain for greater sensitivity in the frequency range from 100 kHz to 3 GHz.

The R&S®HZ-17 H field probe set is an economic near-field probe set for EMI debugging when E field measurements are not required.

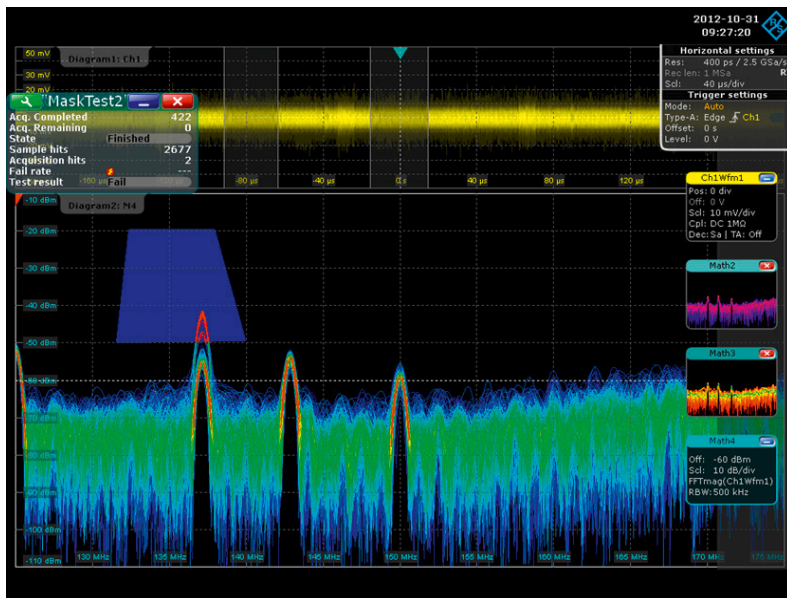

Direct acquisition and analysis of sporadically occurring EMI thanks to the R&S®RTO oscilloscope's powerful spectrum analysis function

Model	Frequency range	Comment	Order No.
Near-field probe			
R&S®HZ-15	30 MHz to 3 GHz	compact E and H near-field probe set	1147.2736.02
R&S®HZ-17	30 MHz to 3 GHz	compact H near-field probe set	1339.4141.02
Accessories			
R&S®HZ-16	100 kHz to 3 GHz	preamplifier 3 GHz, 20 dB, power adapter 100 V to 230 V	1147.2720.02

ORDERING INFORMATION

Designation	Type	Order No.
Probes		
Passive probes		
38 MHz, 1:1, 1 M Ω , 39 pF, 55 V (RMS) CAT II	R&S®RT-ZP1X	1333.1370.02
300 MHz, 10:1, 10 M Ω , 5 mm tip, no probe detection	R&S®RT-ZP03S	1803.1001.02
500 MHz, 10:1, 10 M Ω , 5 mm tip	R&S®RT-ZP05	3623.2927.02
500 MHz, 10:1, 10 M Ω , 400 V (RMS)	R&S®RT-ZP10	1409.7550.00
500 MHz, 10:1, 10 M Ω , 400 V (RMS)	R&S®RTM-ZP10	1409.7708.02
500 MHz, 10:1, 10 M Ω , 12 pF	R&S®RT-ZI10	1326.1761.02
500 MHz, 10:1, 10 M Ω , 11 pF	R&S®RT-ZI10C	1326.3106.02
500 MHz, 10:1, 10 M Ω , 11 pF, dual-pack of R&S®RT-ZI10C	R&S®RT-ZI10C-2	1333.1811.02
500 MHz, 10:1, 10 M Ω , 11 pF, quad-pack of R&S®RT-ZI10C	R&S®RT-ZI10C-4	1333.1328.02
Passive broadband probes		
8.0 GHz, Z0, 10:1, 500 Ω , 20 V (RMS)	R&S®RT-ZZ80	1409.7608.02
Active broadband probes: single-ended		
1.0 GHz, 10:1, 1 M Ω , BNC interface, 50 Ω output	R&S®RT-ZS10L	1333.0815.02
1.0 GHz, 1 M Ω , Rohde&Schwarz probe interface	R&S®RT-ZS10E	1418.7007.02
1.0 GHz, 1 M Ω , R&S®ProbeMeter, micro button, Rohde&Schwarz probe interface	R&S®RT-ZS10	1410.4080.02
1.5 GHz, 1 M Ω , R&S®ProbeMeter, micro button, Rohde&Schwarz probe interface	R&S®RT-ZS20	1410.3502.02
3.0 GHz, 1 M Ω , R&S®ProbeMeter, micro button, Rohde&Schwarz probe interface	R&S®RT-ZS30	1410.4309.02
6.0 GHz, 1 M Ω , R&S®ProbeMeter, micro button, Rohde&Schwarz probe interface	R&S®RT-ZS60	1418.7307.02
Active broadband probes: differential		
1.0 GHz, 1 M Ω , R&S®ProbeMeter, micro button, including 10:1 external attenuator, 1 M Ω , 70 V DC, 46 V AC (peak), Rohde&Schwarz probe interface	R&S®RT-ZD10	1410.4715.02
1.5 GHz, 1 M Ω , R&S®ProbeMeter, micro button, Rohde&Schwarz probe interface	R&S®RT-ZD20	1410.4409.02
3.0 GHz, 1 M Ω , R&S®ProbeMeter, micro button, Rohde&Schwarz probe interface	R&S®RT-ZD30	1410.4609.02
4.5 GHz, 1 M Ω , R&S®ProbeMeter, micro button, Rohde&Schwarz probe interface	R&S®RT-ZD40	1410.5205.02
Modular broadband probes		
Probe amplifier module, 1.5 GHz, 10:1 or 2:1, 400 k Ω (differential mode), 200 k Ω (single-ended mode)	R&S®RT-ZM15	1800.4700.02
Probe amplifier module, 3 GHz, 10:1 or 2:1, 400 k Ω (differential mode), 200 k Ω (single-ended mode)	R&S®RT-ZM30	1419.3005.02
Probe amplifier module, 6 GHz, 10:1 or 2:1, 400 k Ω (differential mode), 200 k Ω (single-ended mode)	R&S®RT-ZM60	1419.3105.02
Probe amplifier module, 9 GHz, 10:1 or 2:1, 400 k Ω (differential mode), 200 k Ω (single-ended mode)	R&S®RT-ZM90	1419.3205.02
Probe amplifier module, 13 GHz, 10:1 or 2:1, 400 k Ω (differential mode), 200 k Ω (single-ended mode)	R&S®RT-ZM130	1800.4500.02
Probe amplifier module, 16 GHz, 10:1 or 2:1, 400 k Ω (differential mode), 200 k Ω (single-ended mode)	R&S®RT-ZM160	1800.4600.02
Power rail probe		
2.0 GHz, 1:1, 50 k Ω , ± 0.85 V, ± 60 V offset, R&S®ProbeMeter	R&S®RT-ZPR20	1800.5006.02
4.0 GHz, 1:1, 50 k Ω , ± 0.85 V, ± 60 V offset, R&S®ProbeMeter	R&S®RT-ZPR40	1800.5406.02
Multi-channel power probe		
1 MHz, 5 Msample/s, 2 \times voltage, 2 \times current	R&S®RT-ZVC02	1326.0259.02
1 MHz, 5 Msample/s, 4 \times voltage, 4 \times current	R&S®RT-ZVC04	1326.0259.04
High voltage probes: passive		
250 MHz, 100:1, 100 M Ω , 850 V (RMS)	R&S®RT-ZH03	1333.0873.02
400 MHz, 100:1, 50 M Ω , 1000 V (RMS) CAT II	R&S®RT-ZH10	1409.7720.02
400 MHz, 1000:1, 50 M Ω , 1000 V (RMS) CAT II	R&S®RT-ZH11	1409.7737.02
500 MHz, 11:1, 100 M Ω , 600 V (RMS) CAT IV, 1000 V (RMS) CAT III, 3540 V (RMS) CAT 0, for R&S®ScopeRider RTH only	R&S®RT-ZI11	1326.1810.02

Designation	Type	Order No.
High voltage probes: differential		
100 MHz, 100:1/1000:1, 8 M Ω , \pm 1400 V, 1000 V (RMS) CAT III	R&S [®] RT-ZD01	1422.0703.02
200 MHz, 25:1/250:1, 5 M Ω , \pm 750 V, 300 V (RMS) CAT III	R&S [®] RT-ZHD07	1800.2307.02
100 MHz, 50:1/500:1, 10 M Ω , \pm 1500 V, 1000 V (RMS) CAT III	R&S [®] RT-ZHD15	1800.2107.02
200 MHz, 50:1/500:1, 10 M Ω , \pm 1500 V, 1000 V (RMS) CAT III	R&S [®] RT-ZHD16	1800.2207.02
100 MHz, 100:1/1000:1, 40 M Ω , \pm 6000 V, 1000 V (RMS) CAT III	R&S [®] RT-ZHD60	1800.2007.02
Current probes		
20 kHz, AC/DC, 0.01 V/A and 0.001 V/A, \pm 200 A and \pm 2000 A	R&S [®] RT-ZC02	1333.0850.02
100 kHz, AC/DC, 0.1 V/A, 20 A (RMS), \pm 30 A (peak)	R&S [®] RT-ZC03	1333.0844.02
2 MHz, AC/DC, 0.01 V/A, 500 A (RMS), Rohde&Schwarz probe interface	R&S [®] RT-ZC05B	1409.8204.02
10 MHz, AC/DC, 0.01 V/A, 150 A (RMS)	R&S [®] RT-ZC10	1409.7750K02
100 MHz, AC/DC, 0.1 V/A, 30 A (RMS)	R&S [®] RT-ZC20	1409.7766K02
120 MHz, AC/DC, 1 V/A, 5 A (RMS)	R&S [®] RT-ZC30	1409.7772K02
120 MHz, AC/DC, 0.1 V/A / 1 V/A / 10 V/A, 30 A, 5 A, 0.5 A (RMS)	R&S [®] RT-ZC31	1801.4932K02
10 MHz, AC/DC, 0.01 V/A, 150 A (RMS), Rohde&Schwarz probe interface	R&S [®] RT-ZC10B	1409.8210.02
50 MHz, AC/DC, 0.1 V/A, 30 A (RMS), Rohde&Schwarz probe interface	R&S [®] RT-ZC15B	1409.8227.02
100 MHz, AC/DC, 0.1 V/A, 30 A (RMS), Rohde&Schwarz probe interface	R&S [®] RT-ZC20B	1409.8233.02
EMC near-field probes		
Compact probe set for E and H near-field measurements, 30 MHz to 3 GHz	R&S [®] HZ-15	1147.2736.02
Compact H near-field probe set, 30 MHz to 3 GHz	R&S [®] HZ-17	1339.4141.02
Logic probes (included with R&S[®]RTx-B1 mixed signal oscilloscope options)		
300 MHz logic probe, 8 channels	R&S [®] RT-ZL03	1333.0715.02
400 MHz logic probe, 8 channels	R&S [®] RT-ZL04	1333.0721.02
Probe accessories		
Accessory set for R&S [®] RT-ZP10 and R&S [®] RT-ZP1X passive probes (2.5 mm probe tip)	R&S [®] RT-ZA1	1409.7566.00
Spare accessory set for R&S [®] RT-ZS10/10E/20/30	R&S [®] RT-ZA2	1416.0405.02
Pin set for R&S [®] RT-ZS10/10E/20/30	R&S [®] RT-ZA3	1416.0411.02
Mini clips	R&S [®] RT-ZA4	1416.0428.02
Micro clips	R&S [®] RT-ZA5	1416.0434.02
Lead set	R&S [®] RT-ZA6	1416.0440.02
Pin set for R&S [®] RT-ZD10/20/30	R&S [®] RT-ZA7	1417.0609.02
Pin set for R&S [®] RT-ZD40	R&S [®] RT-ZA8	1417.0867.02
N(m) adapter for R&S [®] RT-Zxx oscilloscope probes	R&S [®] RT-ZA9	1417.0909.02
SMA adapter	R&S [®] RT-ZA10	1416.0457.02
Probe power supply	R&S [®] RT-ZA13	1409.7789.02
External attenuator 10:1, 2.0 GHz, 1.3 pF, 60 V DC, 42.4 V AC (peak) for R&S [®] RT-ZD20/30 probes	R&S [®] RT-ZA15	1410.4744.02
Extension set for R&S [®] RT-ZI10/11	R&S [®] RT-ZA21	1326.1984.02
Replacement kit for R&S [®] RT-ZHD probes	R&S [®] RT-ZA24	1800.2707.00
Power rail browser kit, included with R&S [®] RT-ZPR20/40	R&S [®] RT-ZA25	1800.5329.00
Pigtail cable, 15 cm, solder-in, SMA for R&S [®] RT-ZPR20/40	R&S [®] RT-ZA26	1800.5258.00
PCB adapter, 2.5 mm	R&S [®] RT-ZA27	1801.4784.02
PCB adapter, 2.5 mm angle	R&S [®] RT-ZA28	1801.4790.02
Probe positioner, 2 legs	R&S [®] RT-ZA29	1801.4803.02
Extended cable set for R&S [®] RT-ZVC, PCB probing, 1 current and 1 voltage lead, length: 32 cm	R&S [®] RT-ZA30	1333.1686.02
Extended cable set for R&S [®] RT-ZVC, 4 mm probing, 1 current and 1 voltage lead, length: 32 cm	R&S [®] RT-ZA31	1333.1692.02
Oscilloscope interface cable for R&S [®] RT-ZVC (included with R&S [®] RT-ZVC02/-ZVC04)	R&S [®] RT-ZA33	1333.1770.02
Extended cable set for R&S [®] RT-ZVC, 4 mm probing, 1 current and 1 voltage lead, length: 1 m	R&S [®] RT-ZA34	1333.1892.02
Extended cable set for R&S [®] RT-ZVC, PCB probing, 1 current and 1 voltage lead, length: 1 m	R&S [®] RT-ZA35	1333.1905.02
Solder-in cable set for R&S [®] RT-ZVC, 4 current and voltage solder-in cables, solder-in pins	R&S [®] RT-ZA36	1333.1911.02
Extended cable set for R&S [®] RT-ZVC, BNC connector, 1 current and 1 voltage lead, length: 16 cm	R&S [®] RT-ZA37	1337.9130.02
Probe tip accessory set for R&S [®] RT-ZP03S, R&S [®] RT-ZP05S, R&S [®] HZO10 and R&S [®] RT-ZH03	R&S [®] RT-ZA40	1338.0742.02
Adapter, Rohde&Schwarz probe interface to 2.92 mm/3.5 mm/SMA, incl. USB-C port	R&S [®] RT-ZA50	1803.5265.02
Adapter, 2.92 mm/3.5 mm/SMA to Rohde&Schwarz probe interface, incl. USB-C port	R&S [®] RT-ZA51	1803.5365.02

Designation	Type	Order No.
Power deskew and calibration test fixture	R&S®RT-ZF20	1800.0004.02
3 GHz, 20 dB preamplifier, 100 V to 230 V power adapter, for R&S®HZ-15	R&S®HZ-16	1147.2720.02
For R&S®RT-ZM probe amplifier module		
3D positioner with central tensioning knob for easy clamping and positioning of probes (span width: 200 mm, clamping range: 15 mm)	R&S®RT-ZAP	1326.3641.02
Probe tip module case for up to 6 R&S®RT-ZMAxx probe tip modules	R&S®RT-ZMA1	1419.3928.02
Solder-in probe tip module, up to 16 GHz	R&S®RT-ZMA10	1419.4301.02
Set of 6 R&S®RT-ZMA10 solder-in probe tip modules	R&S®RT-ZMA10-6	1801.4349.02
Solder-in probe tip module for extended temperature range from -55°C to +125°C, up to 16 GHz	R&S®RT-ZMA11	1419.4318.02
Square-pin probe tip module, up to 6 GHz	R&S®RT-ZMA12	1419.4324.02
Flex connect solder-in probe tip module up to 16 GHz for R&S®RT-ZM probe amplifier module, length: 15 cm, multimode P/N/DM/CM	R&S®RT-ZMA14	1338.1010.02
Quick-connect probe tip module, up to 12 GHz	R&S®RT-ZMA15	1419.4224.02
Browser module, up to 16 GHz	R&S®RT-ZMA30	1419.4353.02
SMA module, up to 16 GHz	R&S®RT-ZMA40	1419.4201.02
Extreme temperature kit, up to 12 GHz	R&S®RT-ZMA50	1419.4218.02
Test fixture for probe characterization with R&S®RTP-B7	R&S®RT-ZF30	1333.2099.02
Accessories		
1 MΩ adapter, for R&S®RTP oscilloscope	R&S®RT-Z1M	1337.9200.02
Probe pouch, for R&S®RTO/RTE oscilloscopes	R&S®RTO-Z5	1317.7031.02
Digital extension port, for R&S®RT-ZVC usage with the R&S®RTE oscilloscope (included with R&S®RTE-B1)	R&S®RTE-B1E	1333.0750.02
Digital extension port, for R&S®RT-ZVC usage with the R&S®RTO oscilloscope (included with R&S®RTO-B1)	R&S®RTO-B1E	1333.0738.02
Digital extension port, for R&S®RT-ZVC usage with the R&S®RTP oscilloscope (included with R&S®RTP-B1)	R&S®RTP-B1E	1337.9581.02
Probe interface adapter, for selected Tektronix probes with TekProbe BNCTM level II interface	R&S®RT-Z2T	1338.0007.02