

Product Datasheet - Technical Specifications



More information in our Web-Shop at ► www.meilhaus.com and in our download section.

Your contact

**Technical and commercial sales, price information,
quotations, demo/test equipment, consulting:**

Tel.: **+49 - 81 41 - 52 71-0**

FAX: **+49 - 81 41 - 52 71-129**

E-Mail: sales@meilhaus.com

Downloads:

www.meilhaus.com/en/infos/download.htm

Meilhaus Electronic GmbH | Tel. **+49 - 81 41 - 52 71-0**
Am Sonnenlicht 2 | Fax **+49 - 81 41 - 52 71-129**
82239 Alling/Germany | E-Mail sales@meilhaus.com

Mentioned company and product names may be registered trademarks of the respective companies. Prices in Euro plus VAT. Errors and omissions excepted.
© Meilhaus Electronic.

www.meilhaus.de

SDG6000X

Series

Pulse/Arbitrary
Waveform Generator

Date Sheet- 2018.04

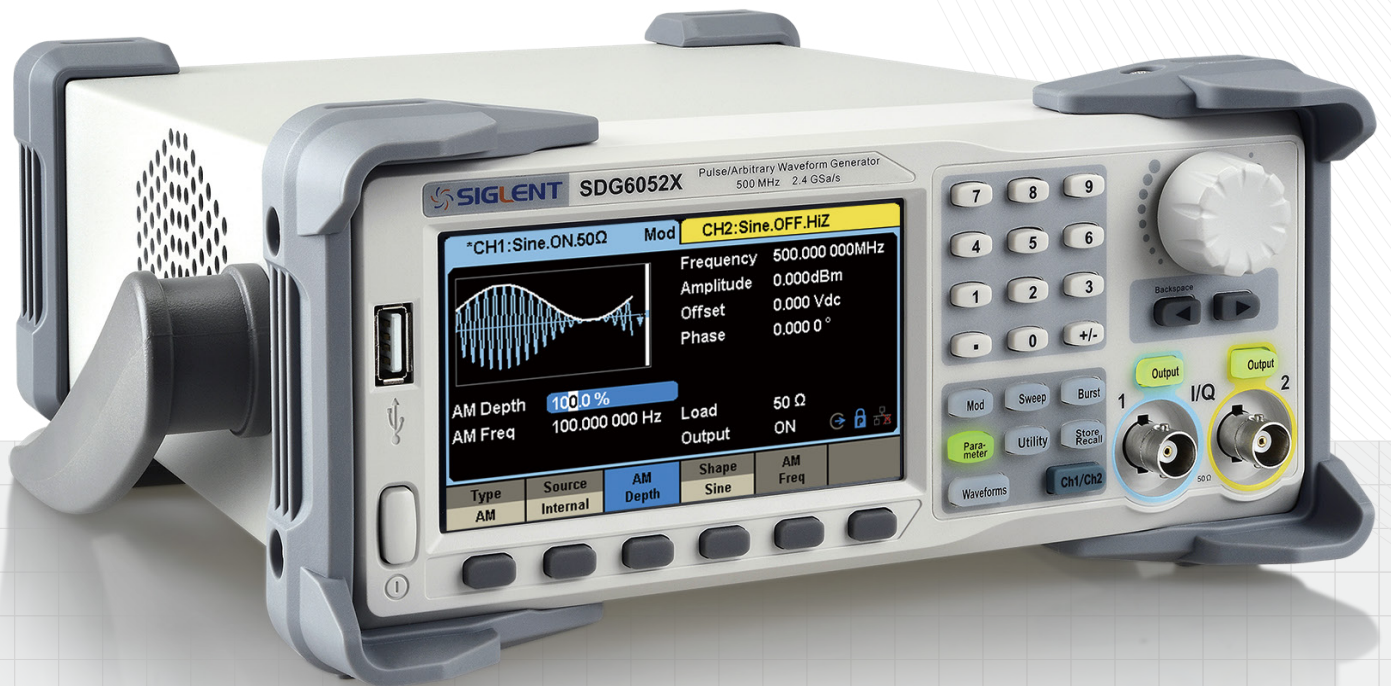

SDG6052X

SDG6032X

SDG6022X





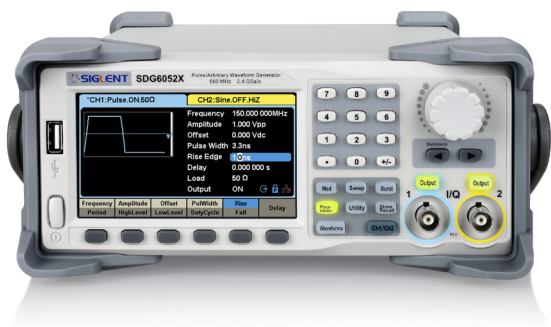

Overview

SIGLENT's SDG6000X is a series of dual-channel Pulse/Arbitrary Waveform Generators that feature up to 500 MHz bandwidth, a maximum sample rate of 2.4 GSa/s and 16-bit vertical resolution. They also include proprietary TrueArb & EasyPulse technology that help to solve the weaknesses inherent in traditional DDS generators when generating arbitrary, square and pulse waveforms. In addition, the SDG6000X is a multi-function device which can generate Noise, IQ signals and PRBS patterns. These features enable the SDG6000X to provide a variety of high fidelity and low jitter signals, meeting the growing requirements of complex and intensive applications.



Key Features

- Dual-Channel, 500 MHz maximum bandwidth, 20 Vpp maximum output amplitude, high fidelity output with 80 dB dynamic range
- High-performance sampling system with 2.4 GSa/s sampling rate and 16-bit vertical resolution
- Multi-function signal generator, meeting requirements in wide range

| | | |
|---|---------------------------------------|---|
|  | Continuous Wave Generator | Up to 500 MHz sine wave, supporting sweep and user-defined harmonics. Low cost replacement of RF signal generators below 500 MHz |
|  | Pulse Generator | Up to 150 MHz Pulse, with finely adjustable width, rising edge and falling edge; 3.3 ns minimum width and 1 ns minimum edge at full frequency range |
|  | Function Arbitrary Waveform Generator | Basic Function/Arbitrary Waveform Generator and complex signals generating capability including modulation, sweep, burst and waveform combination. |
|  | IQ Signal Generator (optional) | Base Band and IF IQ signals supporting basic modulation and an arbitrary symbol rate between 250 Symb/s ~ 37.5 MSymb/s |
|  | Noise Generator | Up to 500 MHz bandwidth White Gaussian Noise with adjustable bandwidth |
|  | PRBS Generator | Up to 300 Mbps PRBS3 ~ PRBS32 with fine bit rate and edge adjustments |

- Sweep and Burst function
- Harmonics function
- Waveform Combining function
- Channel Coupling, Copy and Tracking function
- 196 built-in arbitrary waveforms
- High precision Frequency Counter
- Standard interfaces include: USB Host, USB Device (USBTMC) , LAN (VXI-11, Socket, Telnet) . Optional Interface: GPIB
- 4.3" touch screen display for easier operation

| Model | SDG6022X | SDG6032X | SDG6052X |
|---------------------------|--|----------|----------|
| Bandwidth | 200 MHz | 350 MHz | 500 MHz |
| Number of channels | 2 | | |
| Sampling rate | 2.4 GSa/s (2X Interpolation) | | |
| Vertical resolution | 16 bit | | |
| Arbitrary waveform length | 2 ~ 20 Mpts | | |
| Display | 4.3" touch screen display, 480 x 272 x RGB | | |
| Interface | Standard: USB Host, USB Device, LAN Optional: GPIB (USB-GPIB adaptor) | | |

Characteristics

Continuous Wave

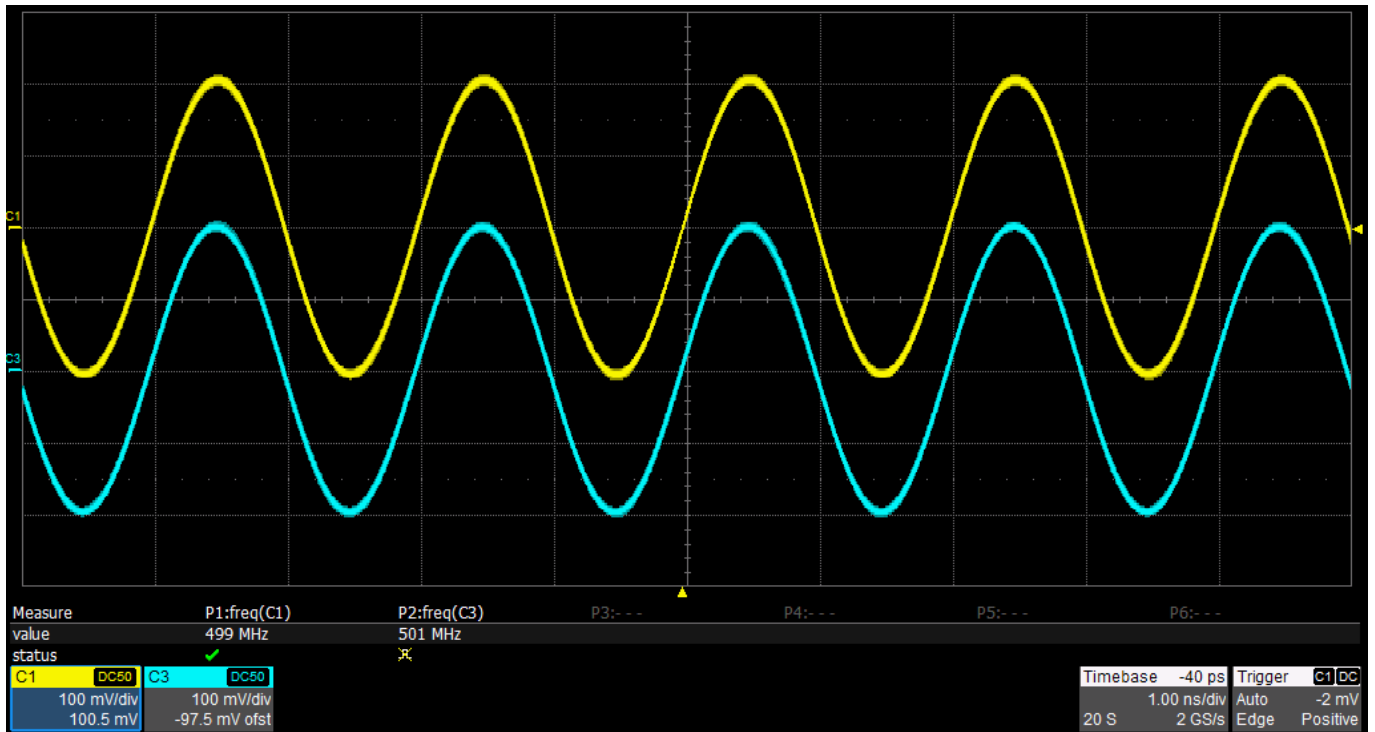

Up to 500MHz continuous sine wave.

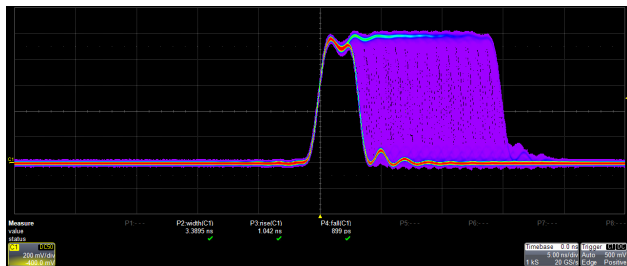

Pulse

Adjustable Pulse Width

The pulse width can be fine-tuned to the minimum of 3.3ns with an adjustment step as small as 100 ps, at any frequency.

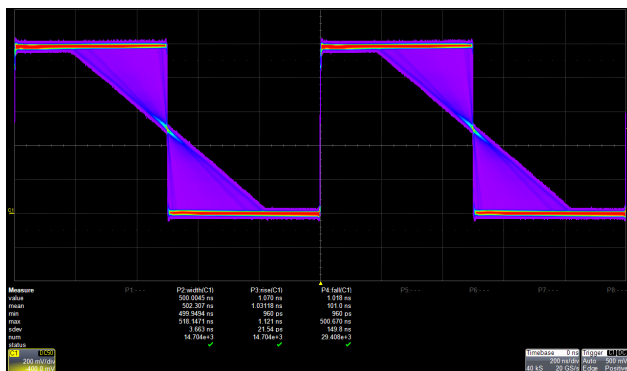

Adjustable Edge

The rise/fall times can be set independently to the minimum of 1ns at any frequency with a minimum adjustment step as small as 100 ps.



Low Jitter

When a Square/Pulse waveform is generated by traditional DDS, there can be additional jitter if the sampling rate is not an integer-related multiple of the output frequency. EasyPulse technology successfully overcomes this weakness in DDS designs and helps to produce low jitter Square/Pulse waveforms.

Arbitrary Waveform

Traditional DDS designs can lead to additional jitter and distortion when sourcing arbitrary waveforms. The SIGLENT TrueArb design minimizes jitter and distortion to help deliver high fidelity arbitrary waveforms.

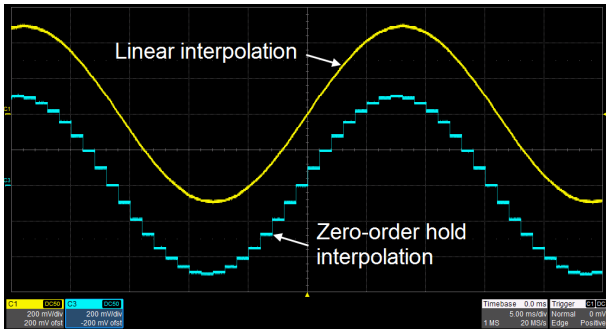

Point by Point Output

TrueArb generates arbitrary waveforms point-by-point. It never skips any point so that it can reconstruct all the details of the waveform, as defined. Two interpolation modes are available: linear and zero-order hold.

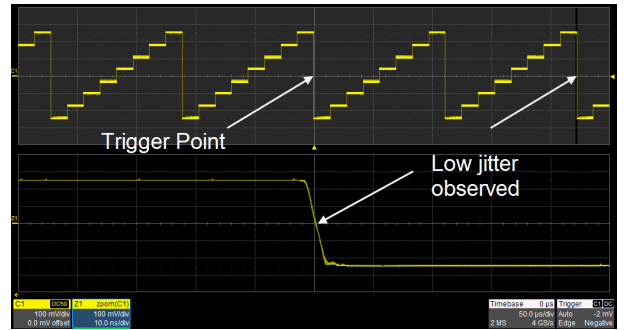

Low Jitter

As with EasyPulse, TrueArb effectively overcomes the clock jitter that can effect traditional DDS generators.

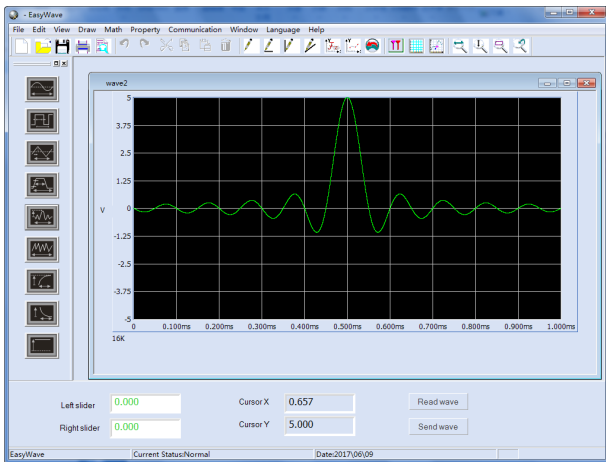

Arbitrary Waveform Software EasyWave

EasyWave is an arbitrary waveform software platform that supports waveform creation and editing. It features manual drawing, as-well-as line, equation, and coordinate editing modes. It is also a convenient way for users to edit their own arbitrary waveforms.

Noise

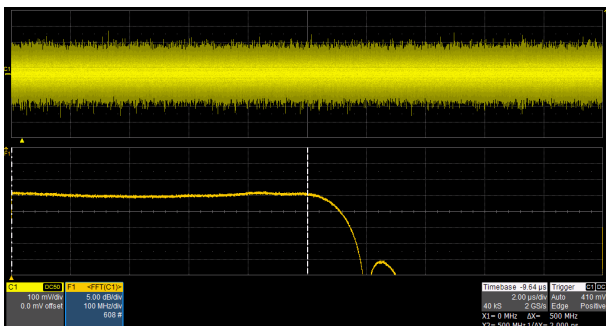

Gaussian noise with bandwidth up to 500 MHz. The repetition period is more than 100 years, and the bandwidth is adjustable.

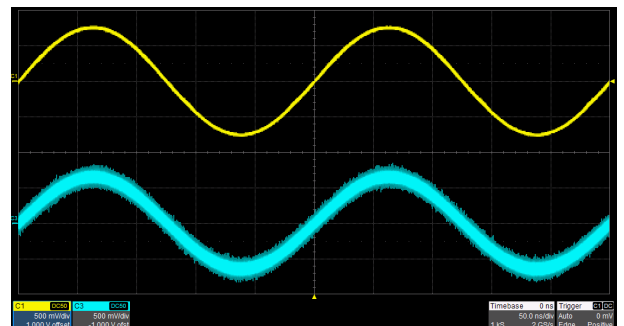

Wideband Gaussian noise can be easily added to other waveforms to simulate real-world scenarios in which the signal contains a large degree of noise.

IQ (optional)

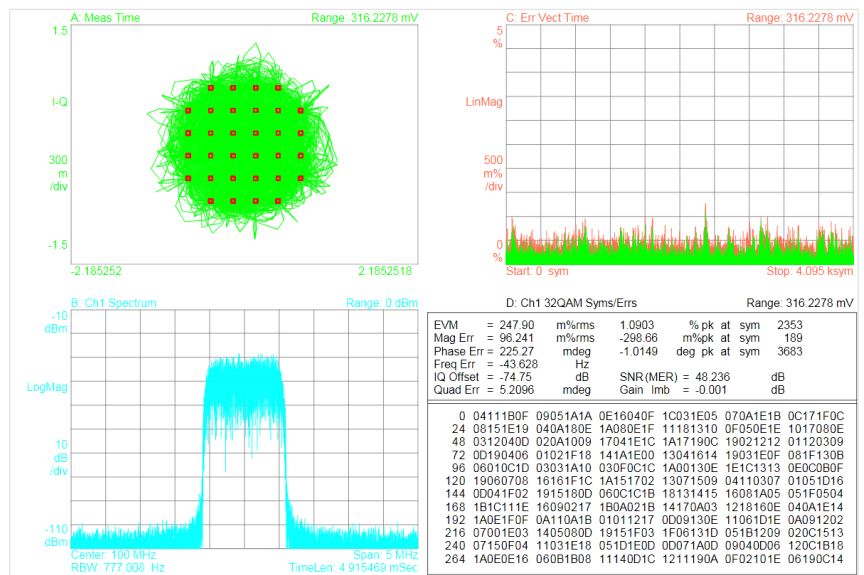
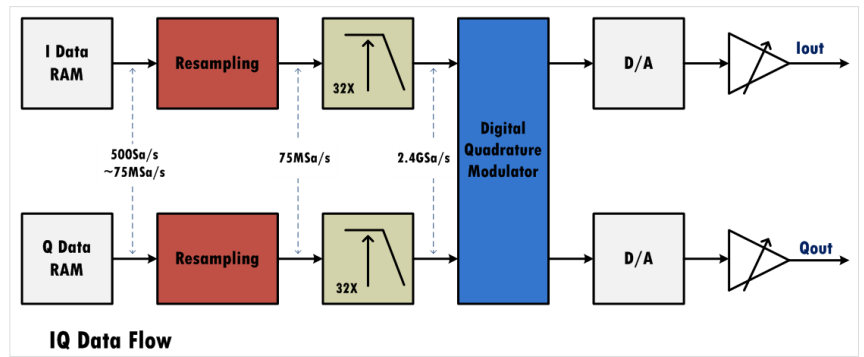

The SDG6000X supports popular modulation types such as ASK, FSK, PSK, and QAM. Proprietary resampling technology provides excellent EVM performance at arbitrary symbol rates between 250 Symb/s ~ 37.5 MSymb/s. Built-in digital quadrature modulator provides the possibility to generate IQ signals from baseband to 500 MHz intermediate frequency.

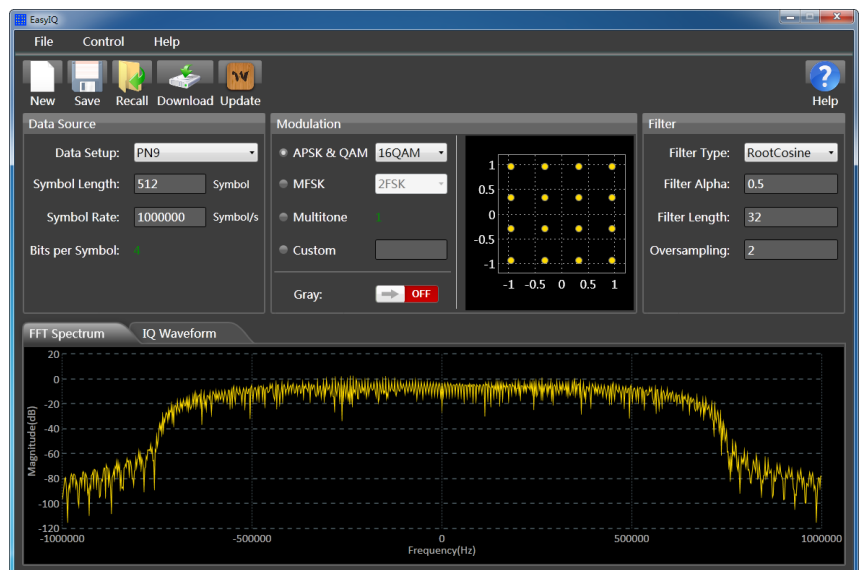

IQ waveforms can be generated by the PC software EasyIQ.

PRBS

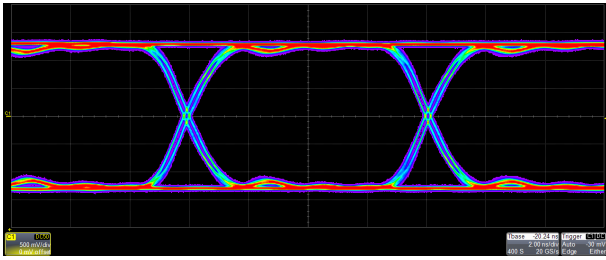

PRBS3 ~ PRBS32 with finely adjustable 10^6 bps ~ 300 Mbps bit rate and 1 ns ~ 1us edge.

CH1:PRBS.ON.50Ω CH2:PRBS.ON.50Ω

Bit Rate 122.880 000Mbps
 Amplitude 800.0mVpp
 Offset 850.0mVdc
 Length PRBS-30
 Rise/Fall 2.0ns

Load 50 Ω
 Output ON

TTL/CMOS LVTTTL LVCOMS ECL LVPECL LVDS Differential ON

Preset common logic levels such as TTL, LVCMOS, LVPECL and LVDS. An added differential mode provides an easy way to generate differential signals using the both channels.

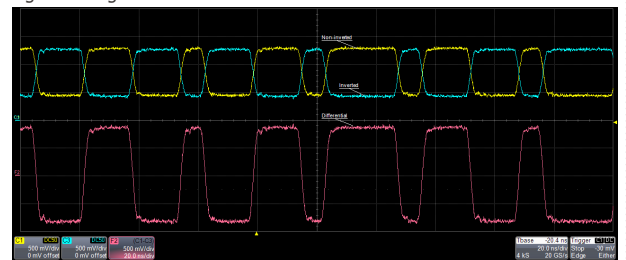

High Fidelity Output with 80dB Dynamic Range

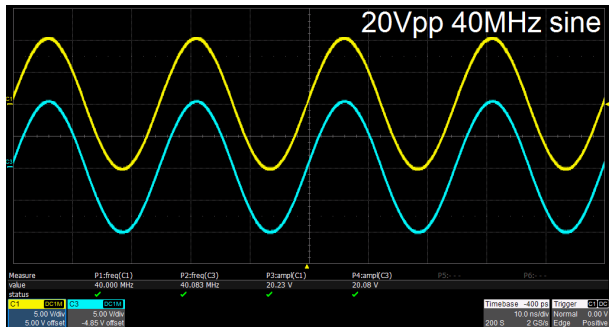

Large Signals at High Frequencies

Dual-channel, 20 Vpp amplitude sine wave guaranteed at up to 40 MHz.

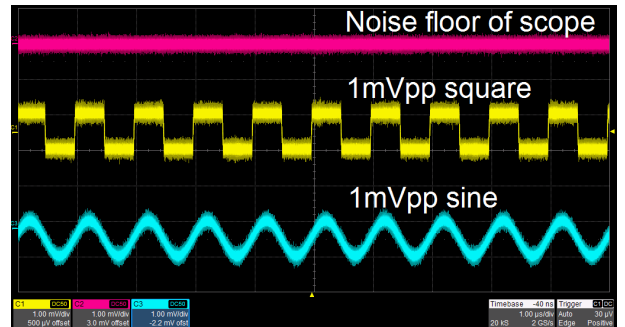

Small Signals

Low noise floor, improves signal-to-noise ratio.

Complex Signals Generation

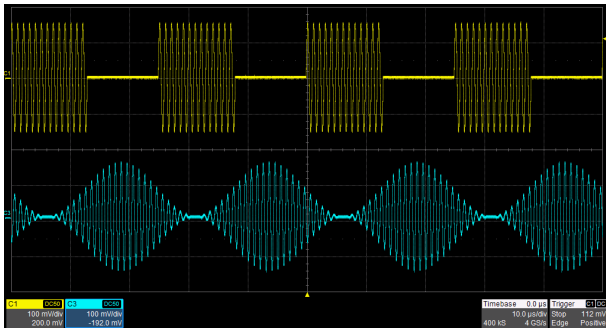

Modulation

Plenty of modulation types, such as AM, FM, PM, FSK, ASK, PSK, DSB-AM, PWM are supported. The modulation source can be configured as "Internal" or "External".

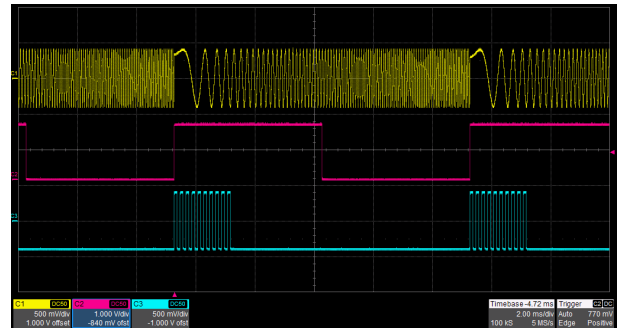

Sweep and Burst

Sweep modes include "Linear" and "Log". Burst modes includes "N cycle" and "Gated". Both Sweep and Burst can be triggered by "Internal", "External" or "Manual" source.

Waveform Combining

The waveform combining function superimposes CH1 and CH2 waveforms internally and provides the combined waveform to a user-selected output. Easily combine basic waveforms, random noise, modulation signals, sweep signals, burst signals, EasyPulse waveforms and TrueArb waveforms

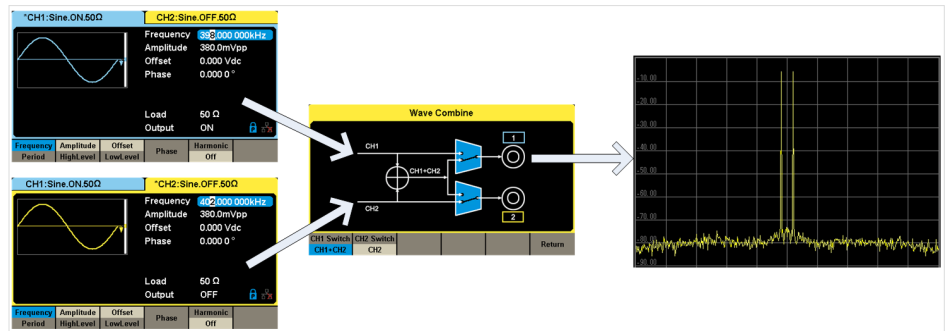

Harmonics Function

Harmonics function gives you the ability to add higher-order elements to your signal.

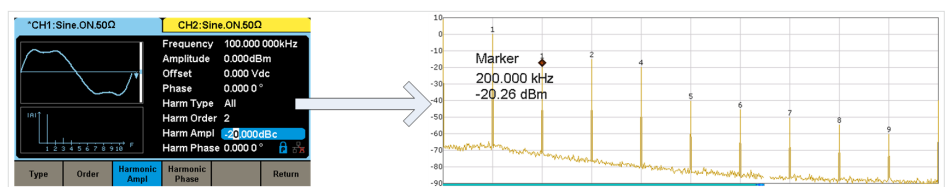

Two Dual-channel Operation Mode

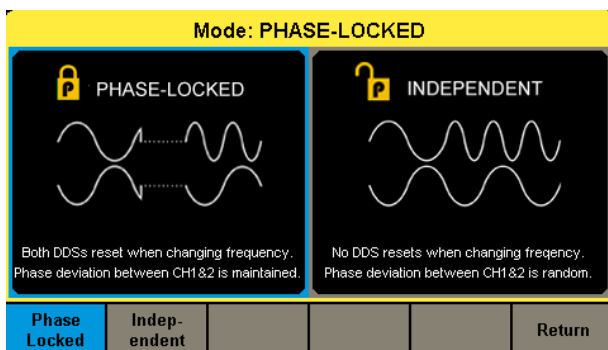

"Phase-Locked" mode automatically aligns the phases of each output. While "Independent" mode permit the two channels to be used as two independent generators. Independent mode also smoothes parameter (frequency, amplitude) changes made to an active channel.

Frequency Counter

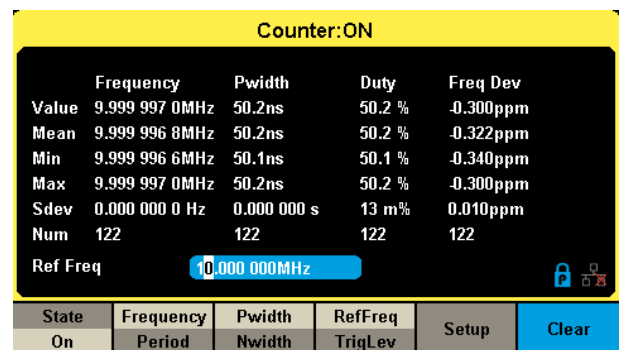

8-digit hardware frequency counter with statistics function and input range of 0.1 Hz ~ 400 MHz.

Specifications

All specifications apply to both channels. Unless otherwise stated, all specifications are not guaranteed unless the following conditions are met:

- The generator is within the valid calibration period
- The generator has been working continuously for at least 30 minutes at a specified temperature (18 °C ~ 28 °C)

| Frequency | | | | | |
|-----------------------------|------|------|------|------|------------------|
| Parameter | Min. | Typ. | Max. | Unit | Condition & Note |
| Resolution | 1μ | | | Hz | |
| Initial accuracy | -1 | | +1 | ppm | 25°C |
| | -2 | | +2 | ppm | 0~40°C |
| 1 st -year aging | -1 | | +1 | ppm | 25°C |
| 10-year aging | -3.5 | | +3.5 | ppm | 25°C |

| Sine | | | | | |
|---------------------------|----------------|------|-------|------|--|
| Parameter | Min. | Typ. | Max. | Unit | Condition & Note |
| Frequency | 1μ | | 500M | Hz | SDG6052X |
| | 1μ | | 350M | Hz | SDG6032X |
| | 1μ | | 200M | Hz | SDG6022X |
| Harmonic distortion | | | -65 | dBc | 0 dBm, 0~1 MHz (included) |
| | | | -60 | dBc | 0 dBm, 1~60 MHz (included) |
| | | | -50 | dBc | 0 dBm, 60~100 MHz (included) |
| | | | -40 | dBc | 0 dBm, 100~200 MHz (included) |
| | | | -30 | dBc | 0 dBm, 200~300 MHz (included) |
| | | | -28 | dBc | 0 dBm, above 300 MHz |
| Total Harmonic Distortion | | | 0.075 | % | 0 dBm, 10 Hz ~ 20 kHz |
| Non-harmonic spurious | | | -60 | dBc | 0 dBm, ≤350 MHz |
| | | | -55 | dBc | 0 dBm, >350 MHz |
| Output Range (Note) | 2m | | 20 | Vpp | ≤ 40 MHz, HiZ load |
| | 2m | | 10 | Vpp | 40 MHz ~ 120 MHz (included), HiZ load |
| | 2m | | 5 | Vpp | 120 MHz ~ 160 MHz (included), HiZ load |
| | 2m | | 3 | Vpp | 160 MHz ~ 350 MHz (included), HiZ load |
| | 2m | | 1.28 | Vpp | above 350MHz, HiZ load |
| Harmonics Order | | | 10 | | |
| Type | Even, Odd, All | | | | |

Note : The specification will be divided by 2 while applied to a 50Ω load.

Pulse

| Parameter | Min. | Typ. | Max. | Unit | Condition & Note |
|--------------------------------|---------|------|----------------------------|------|---|
| Frequency | 1 μ | | 150 M | Hz | SDG6052X, SDG6032X |
| | 1 μ | | 80 M | Hz | SDG6022X |
| Pulse Width | 3.3 | | | ns | SDG6052X, SDG6032X |
| | 3.4 | | | ns | SDG6022X |
| Pulse width resolution | 100 | | | ps | |
| Pulse width accuracy | | | $\pm(0.01\%+0.3\text{ns})$ | | |
| Rise time (setting range) | 1n | | | s | SDG6052X, SDG6032X 10% ~ 90% |
| | 2n | | | s | SDG6022X 10% ~ 90% |
| Fall time (setting range) | 1n | | | s | SDG6052X, SDG6032X 90% ~ 10% |
| | 2n | | | s | SDG6022X 90% ~ 10% |
| Rise time (specified range) | 2n | | | s | 10% ~ 90%. Overshoot, jitter, output range and pulse width accuracy specifications are only guaranteed in specified rise/fall times range |
| Fall time (specified range) | 2n | | | s | |
| Rise/fall times resolution | 100 | | | ps | |
| Overshoot | | | 3 | % | 100 kHz, 1 Vpp, 50 Ω load , 2 ns edge |
| Duty cycle | 0.001 | | 99.999 | % | Limited by frequency setting |
| Duty cycle resolution | 0.001 | | | % | |
| Jitter (rms) cycle to cycle | | | 100 | ps | 1 Vpp, 50 Ω load |
| Output Range (Note) | 2m | | 20 | Vpp | \leq 20 MHz, HiZ load , 2ns edge , \geq 10 ns width |
| | 2m | | 10 | Vpp | 20 MHz ~ 120 MHz (included) , HiZ load , 2ns edge , \geq 10 ns width |
| | 2m | | 5 | Vpp | Above 120 MHz , HiZ load , 2ns edge , \geq 10 ns width |

Note : The specification will be divided by 2 while applied to a 50 Ω load.

Square

| Parameter | Min. | Typ. | Max. | Unit | Condition & Note |
|-----------------------------|---------|------|------|------|------------------------------------|
| Frequency | 1 μ | | 120M | Hz | SDG6052X, SDG6032X |
| | 1 μ | | 80M | Hz | SDG6022X |
| Rise /fall times | | 2 | 2.4 | ns | 10% ~ 90%, 1 Vpp, 50 Ω load |
| Overshoot | | | 3 | % | 100 kHz, 1 Vpp, 50 Ω load |
| Duty cycle | 10 | | 90 | % | Limited by frequency setting |
| Jitter (rms) cycle to cycle | | | 100 | ps | 1 Vpp, 50 Ω load |
| Output Range (Note) | 2m | | 20 | Vpp | \leq 20 MHz, HiZ load |
| | 2m | | 10 | Vpp | Above 20 MHz , HiZ load |

Note : The specification will be divided by 2 while applied to a 50 Ω load.

Ramp

| Parameter | Min. | Typ. | Max. | Unit | Condition & Note |
|---------------------|---------|------|------|------|---|
| Frequency | 1 μ | | 5M | Hz | |
| Symmetry | 0 | | 100 | % | |
| Linearity | | | 1 | % | Percentage of peak output, 1 kHz, 1 Vpp, 50% symmetry |
| Output Range (Note) | 2m | | 20 | Vpp | |

Note : The specification will be divided by 2 while applied to a 50 Ω load.

Noise

| Parameter | Min. | Typ. | Max. | Unit | Condition & Note |
|-------------------------|------|------|-------|------|-----------------------------------|
| Bandwidth (-3dB) | | 500 | | MHz | SDG6052X |
| | | 350 | | MHz | SDG6032X |
| | | 200 | | MHz | SDG6022X |
| Bandwidth setting range | 1m | | BW | Hz | BW is the max. frequency |
| Output Range (Note) | 2m | | 1.084 | Vrms | Mean = 0 Bandwidth limit = OFF |

Note : The specification will be divided by 2 while applied to a 50Ω load.

Arbitrary Wave

| Parameter | Min. | Typ. | Max. | Unit | Condition & Note |
|-----------------------------|------|------|------|------|--|
| Frequency setting range | 1μ | | 50M | Hz | |
| Waveform length | 2 | | 20M | pts | |
| Sampling rate | 1u | | 300M | Sa/s | TrueArb mode |
| | | 1.2G | | Sa/s | DDS mode |
| Vertical resolution | | 16 | | bit | |
| Rise/fall times | | 2.6 | | ns | 10% ~ 90%, 1Vpp step signal , DDS mode |
| Jitter (rms) cycle to cycle | | | 100 | ps | 1 Vpp, 50Ω load , TrueArb mode |
| Output Range (Note) | 2m | | 20 | Vpp | ≤ 20 MHz, HiZ load |
| | 2m | | 10 | Vpp | Above 20 MHz , HiZ load |

Note : The specification will be divided by 2 while applied to a 50Ω load.

DC

| Parameter | Min. | Typ. | Max. | Unit | Condition & Note |
|--------------|------|------|-----------|------|------------------|
| Output Range | -10 | | 10 | V | HiZ load |
| | -5 | | 5 | V | 50Ω load |
| Accuracy | | | ±(1%+2mV) | | HiZ load |

IQ (optional)

| Parameter | Min. | Typ. | Max. | Unit | Condition & Note |
|---------------------|---|------|-------|--------|------------------------------------|
| Symbol rate | 250 | | 37.5M | Symb/s | Limited by the oversampling factor |
| Vertical resolution | | 16 | | bit | |
| Modulation type | 2ASK, 4ASK, 8ASK, BPSK, QPSK, 8PSK, DBPSK, DQPSK, D8PSK, 8QAM, 16QAM, 32QAM, 64QAM, 128QAM, 256QAM, 2FSK, 4FSK, 8FSK, 16FSK, MSK, MultiTone, custom | | | | Supported by EasyIQ software |
| Pattern | PN7, PN9, PN15, PN23, User file, Custom | | | | Supported by EasyIQ software |
| Output Range | 1m | | 0.5 | Vrms | $\sqrt{I^2 + Q^2}$, 50Ω load |
| Carrier frequency | | | 500M | Hz | SDG6052X |
| | | | 350M | Hz | SDG6032X |
| | | | 200M | Hz | SDG6022X |

PRBS

| Parameter | Min. | Typ. | Max. | Unit | Condition & Note |
|---------------------|--------------------------------|------|------|------|--|
| Bit rate | 1u | | 300M | bps | SDG6052X, SDG6032X |
| | 1u | | 160M | bps | SDG6022X |
| Sequence length | 2^{m-1} , m = 3, 4, ... , 32 | | | | |
| Rise/fall times | 1n | | 1u | s | SDG6052X, SDG6032X. 10% ~ 90%, 1 Vpp, 50Ω load |
| | 2n | | 1u | s | SDG6022X. 10% ~ 90%, 1 Vpp, 50Ω load |
| Output Range (Note) | 2m | | 20 | Vpp | ≤ 40 Mbps, HiZ load , |
| | 2m | | 10 | Vpp | 40 ~ 240 Mbps (included), HiZ load |
| | 2m | | 5 | Vpp | Above 240 Mbps , HiZ load |

Note : The specification will be divided by 2 while applied to a 50Ω load.

Output

| Parameter | Min. | Typ. | Max. | Unit | Condition & Note |
|-----------------------------------|---|------|-------|------|---|
| Accuracy | $\pm(1\%+1mVpp)$ | | | | 10 kHz sine, 0 V offset |
| Amplitude flatness | -0.3 | | +0.3 | dB | 50Ω load, 0.5 Vpp, compare to 1MHz Sine |
| Output impedance | 49.5 | 50 | 50.5 | Ω | 100 kHz sine |
| Output current | -200 | | 200 | mA | |
| Crosstalk | | | -60 | dBc | CH1=CH2=0 dBm, Sine, 50 Ω load |
| Protection | Current limiting, Over voltage protection | | | | |
| Current-limit threshold | | ±200 | | mA | |
| Over voltage protection threshold | ±3.5 | ±4 | ±4.5 | V | The amplitude of the generator <3.2Vpp and the DC offset < 2VDC |
| | ±10.5 | ±11 | ±11.5 | V | The amplitude of the generator ≥3.2Vpp or the DC offset ≥ 2VDC |

Modulation

AM

| Parameter | Min. | Typ. | Max. | Unit | Condition & Note |
|----------------------|--------------------------------|------|------|------|---------------------------------------|
| Carrier | Sine, Square, Ramp, Arb | | | | |
| Modulation source | Internal/External | | | | |
| Modulation wave | Sine, Square, Ramp, Noise, Arb | | | | |
| Modulation depth | 0 | | 120 | % | |
| Modulation frequency | 1m | | 1M | Hz | While modulation source is "Internal" |

FM

| Parameter | Min. | Typ. | Max. | Unit | Condition & Note |
|----------------------|--------------------------------|------|--------|------|--|
| Carrier | Sine, Square, Ramp, Arb | | | | |
| Modulation source | Internal/External | | | | |
| Modulation wave | Sine, Square, Ramp, Noise, Arb | | | | |
| Frequency deviation | 0 | | 0.5*BW | | BW is the max. frequency. Limited by frequency setting |
| Modulation frequency | 1m | | 1M | Hz | While modulation source is "Internal" |

PM

| Parameter | Min. | Typ. | Max. | Unit | Condition & Note |
|----------------------|--------------------------------|------|------|------|---------------------------------------|
| Carrier | Sine, Square, Ramp, Arb | | | | |
| Modulation source | Internal/External | | | | |
| Modulation wave | Sine, Square, Ramp, Noise, Arb | | | | |
| Phase deviation | 0 | | 360 | ° | |
| Modulation frequency | 1m | | 1M | Hz | While modulation source is "Internal" |

| ASK | | | | | |
|----------------------|--------------------------------|------|------|------|---------------------------------------|
| Parameter | Min. | Typ. | Max. | Unit | Condition & Note |
| Carrier | Sine, Square, Ramp, Arb | | | | |
| Modulation source | Internal/External | | | | |
| Modulation wave | Square with 50% duty cycle | | | | |
| Keying frequency | 1m | | 1M | Hz | While modulation source is "Internal" |
| FSK | | | | | |
| Parameter | Min. | Typ. | Max. | Unit | Condition & Note |
| Carrier | Sine, Square, Ramp, Arb | | | | |
| Modulation source | Internal/External | | | | |
| Modulation wave | Square with 50% duty cycle | | | | |
| Keying frequency | 1m | | 1M | Hz | While modulation source is "Internal" |
| PSK | | | | | |
| Parameter | Min. | Typ. | Max. | Unit | Condition & Note |
| Carrier | Sine, Square, Ramp, Arb | | | | |
| Modulation source | Internal/External | | | | |
| Modulation wave | Square with 50% duty cycle | | | | |
| Keying frequency | 1m | | 1M | Hz | While modulation source is "Internal" |
| PWM | | | | | |
| Parameter | Min. | Typ. | Max. | Unit | Condition & Note |
| Carrier | Pulse | | | | |
| Modulation source | Internal/External | | | | |
| Modulation wave | Sine, Square, Ramp, Noise, Arb | | | | |
| Modulation frequency | 1m | | 1M | Hz | While modulation source is "Internal" |

| Burst | | | | | |
|-------------------|--|------|------|------|---------------------------------|
| Parameter | Min. | Typ. | Max. | Unit | Condition & Note |
| Carrier | Sine, Square, Ramp, Pulse, Noise, Arb | | | | |
| Type | Count (1-1000000 periods), Infinite, Gated | | | | |
| Carrier frequency | 2m | | BW | Hz | BW is the max. output frequency |
| Start/Stop phase | 0 | | 360 | ° | |
| Internal period | 1μ | | 1000 | s | |
| Trigger source | Internal, External, Manual | | | | |
| Gated source | Internal/External | | | | |
| Trigger delay | | | 100 | s | |

| Sweep | | | | | |
|-------------------|--|------|------|------|---------------------------------|
| Parameter | Min. | Typ. | Max. | Unit | Condition & Note |
| Carrier | Sine, Square, Ramp, Arb | | | | |
| Type | Linear, Logarithmic | | | | |
| Direction | Linear: Up, Down, Up & Down Logarithmic: Up, Down | | | | |
| Carrier frequency | 1μ | | BW | Hz | BW is the max. output frequency |
| Sweep time | 1m | | 500 | s | |
| Trigger source | Internal, External, Manual | | | | |

Frequency Counter

| Parameter | Min. | Typ. | Max. | Unit | Condition & Note |
|-----------------|--|------|-------|------|--------------------------------|
| Function | Frequency, Period, Positive/Negative Pulse Width, Duty Cycle | | | | |
| Coupling mode | AC, DC, HF REJ | | | | |
| Frequency range | 100m | | 400M | Hz | DC coupling |
| Input amplitude | 1 | | 400M | Hz | AC coupling |
| | 100mVrms | | ±2.5V | | DC coupling , < 100 MHz |
| | 200mVrms | | ±2.5V | | DC coupling , 100 MHz ~ 200MHz |
| | 500mVrms | | ±2.5V | | DC coupling , Above 200 MHz |
| | 100mVrms | | 5 Vpp | | AC coupling , < 100 MHz |
| | 200mVrms | | 5 Vpp | | AC coupling , 100 MHz ~ 200MHz |
| | 500mVrms | | 5 Vpp | | AC coupling , Above 200 MHz |
| Input impedance | | 1M | | Ω | |

Reference Clock

10MHz Input

| Parameter | Min. | Typ. | Max. | Unit | Condition & Note |
|-----------------|--------|------|---------|------|------------------|
| Frequency | 9.999M | 10M | 10.001M | Hz | |
| Amplitude | 1.4 | | | Vpp | |
| Input impedance | 5 | | | kΩ | AC coupling |

10MHz Output

| Parameter | Min. | Typ. | Max. | Unit | Condition & Note |
|------------------|------|------|------|------|--|
| Frequency | | 10M | | Hz | Synchronized to internal reference clock |
| Amplitude | 2 | 3.3 | | Vpp | HiZ load |
| Output impedance | | 50 | | Ω | |

Auxiliary In/Out

Trigger Input

| Parameter | Min. | Typ. | Max. | Unit | Condition & Note |
|-----------------|------|------|------|------|------------------|
| V _{IH} | 2 | | 5.5 | V | |
| V _{IL} | -0.5 | | 0.8 | V | |
| Input impedance | 100 | | | kΩ | |
| Pulse width | 100 | | | ns | |
| Response time | | | 100 | ns | Sweep |
| | | | 600 | ns | Burst |

Trigger Output

| Parameter | Min. | Typ. | Max. | Unit | Condition & Note |
|------------------|------|------|------|------|-------------------------|
| V _{OH} | 3.8 | | | V | I _{OH} = -8 mA |
| V _{OL} | | | 0.44 | V | I _{OL} = 8 mA |
| Output impedance | | 100 | | Ω | |
| Frequency | | | 1 | MHz | |

| Sync Out | | | | | |
|----------------------------------|------|------|------|-----------------|-------------------------|
| Parameter | Min. | Typ. | Max. | Unit | Condition & Note |
| V _{OH} | 3.8 | | | V | I _{OH} = -8 mA |
| V _{OL} | | | 0.44 | V | I _{OL} = 8 mA |
| Output impedance | | 100 | | Ω | |
| Pulse width | | 26.7 | | ns | |
| Jitter | | 3.3 | | ns | Peak to peak |
| Frequency | | | 10 | MHz | |
| Modulation Input | | | | | |
| Parameter | Min. | Typ. | Max. | Unit | Condition & Note |
| Frequency | 0 | | 50 | kHz | |
| Input impedance | 10 | | | kΩ | |
| Amplitude @100% modulation depth | 11 | 12 | 13 | V _{pp} | |

| General | | | | | |
|-------------------------|--|-------|-------|-------------------|--|
| Power | | | | | |
| Parameter | Min | Typ | Max | Unit | Condition |
| Voltage | 100 - 240 Vrms (± 10%), 50 / 60 Hz 100 - 120 Vrms (± 10%), 400 Hz | | | | |
| Power consumption | | 32.5 | 50 | W | Dual channels, Sine, 1kHz, 10Vpp, 50Ω load |
| Display | | | | | |
| Parameter | Min. | Typ. | Max. | Unit | Condition & Note |
| Color depth | | 24 | | bit | |
| Contrast Ratio | | 350:1 | | | |
| Luminance | | 300 | | cd/m ² | |
| Touch Screen Type | Resistive | | | | |
| Environment | | | | | |
| Parameter | Min. | Typ. | Max. | Unit | Condition & Note |
| Operating temperature | 0 | | 40 | °C | |
| Storage temperature | -20 | | 60 | °C | |
| Operating humidity | 5 | | 90 | % | ≤ 30 °C |
| | 5 | | 50 | % | 40 °C |
| Non -operating humidity | 5 | | 95 | % | |
| Operating altitude | | | 3048 | m | ≤ 30 °C |
| Non -operating altitude | | | 15000 | m | |
| Calibration | | | | | |
| Parameter | Min. | Typ. | Max. | Unit | Condition & Note |
| Calibration interval | | 1 | | year | |
| Mechanical | | | | | |
| Parameter | Min. | Typ. | Max. | Unit | Condition & Note |
| Dimensions | W×H×D = 260.3mm×107.2mm×295.7mm | | | | |
| Net weight | | 3.5 | | kg | |
| Gross weight | | 4.6 | | kg | |
| Compliance | | | | | |
| LVD | IEC 61010-1:2010 | | | | |
| EMC | EN61326-1:2013 | | | | |

Ordering Information

Product Description

| | |
|----------|----------------------------------|
| SDG6052X | 500 MHz, 2-CH, 2.4 GSa/s, 16-bit |
| SDG6032X | 350 MHz, 2-CH, 2.4 GSa/s, 16-bit |
| SDG6022X | 200 MHz, 2-CH, 2.4 GSa/s, 16-bit |

Standard Configurations

Quick start ×1

Power cord ×1

Calibration certificate ×1

USB cable ×1

BNC coaxial cable x2

Optional Configurations

| | |
|--------------|----------------------------------|
| SPA1010 | 10W Power Amplifier |
| ATT-20dB | 20 dB Attenuator |
| USB-GPIB | USB-GPIB Adapter |
| SDG-RMK | Single Instrument Rack Mount Kit |
| SDG-6000X-IQ | IQ Signal Generator Function |