

Product Datasheet - Technical Specifications



More information in our Web-Shop at ► www.meilhaus.com and in our download section.

Your contact

**Technical and commercial sales, price information,
quotations, demo/test equipment, consulting:**

Tel.: **+49 - 81 41 - 52 71-0**

FAX: **+49 - 81 41 - 52 71-129**

E-Mail: sales@meilhaus.com

Downloads:
www.meilhaus.com/en/infos/download.htm

Meilhaus Electronic GmbH | Tel. **+49 - 81 41 - 52 71-0**
Am Sonnenlicht 2 | Fax **+49 - 81 41 - 52 71-129**
82239 Alling/Germany | E-Mail sales@meilhaus.com

Mentioned company and product names may be registered trademarks of the respective companies. Prices in Euro plus VAT. Errors and omissions excepted.
© Meilhaus Electronic.

www.meilhaus.de

Signal Conditioners: microBlox® Series

Acromag Agility™ Config Tool Mobile Application

The Agility™ Config Tool is a mobile application that allows easy setup and configuration of Acromag microBlox® Series signal conditioners and alarms.

You can download the Agility application free of charge from the Google Play™ store at play.google.com (Android), or the Apple® App Store® at itunes.apple.com (Apple iOS).

Demo the software, no need for a module. To enter demo mode simply tap the  icon in the upper left corner 8 times.

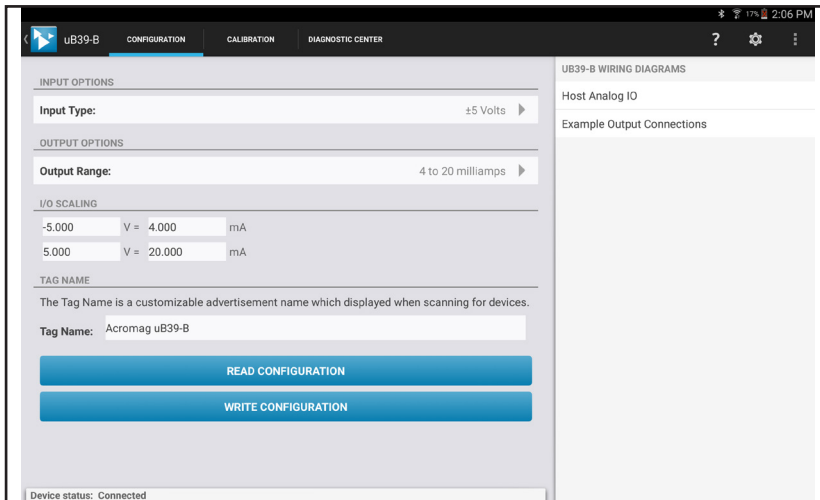
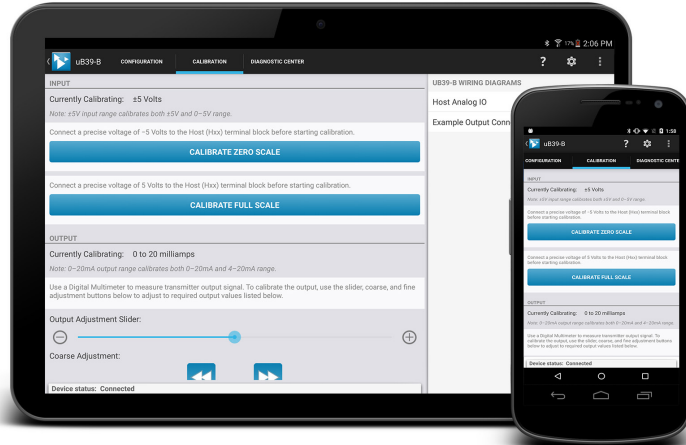

With a couple of taps, quickly configure input, output, unit and scaling options.

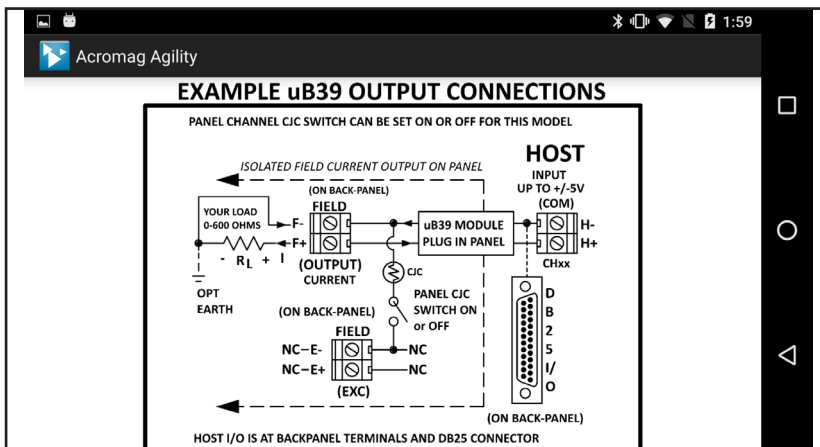

Quick and easy access to the wiring diagram, even offline without internet access.

Key Features & Benefits

- Connects to microBlox signal conditioners via Bluetooth wireless technology
- Requires the use of a smart device
- Configures and calibrates microBlox UB Series products via phone or tablet running Android 4.3 or later or iOS 8.1 or later.
- View wiring diagrams, even without an internet connection
- Perform quick and easy field diagnostics and troubleshooting
- Ideal for field technicians
- Trend and share field data

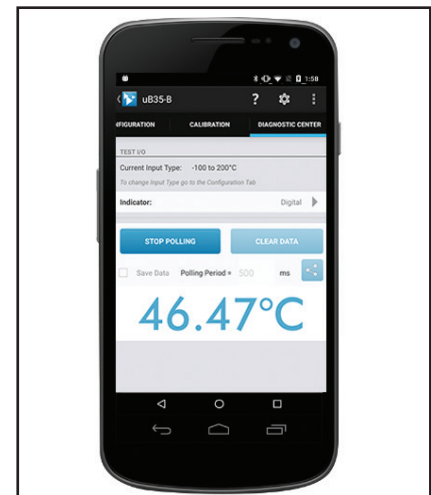

Signal Conditioners: microBlox™ Series

Acromag Agility™ Config Tool Mobile Application

Alarm Function

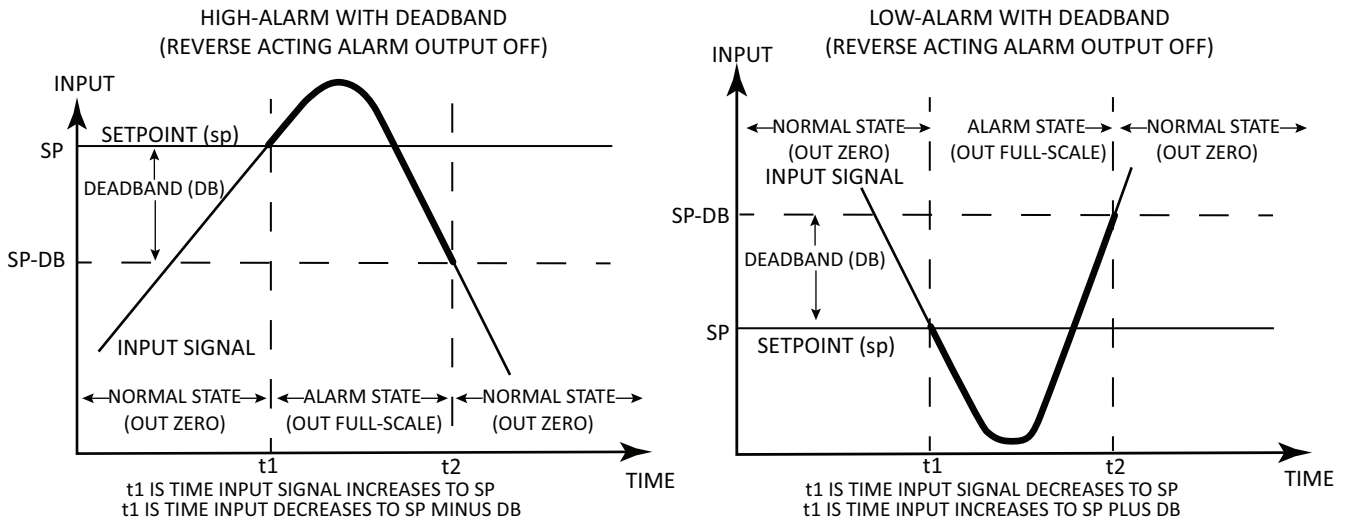

Calibration

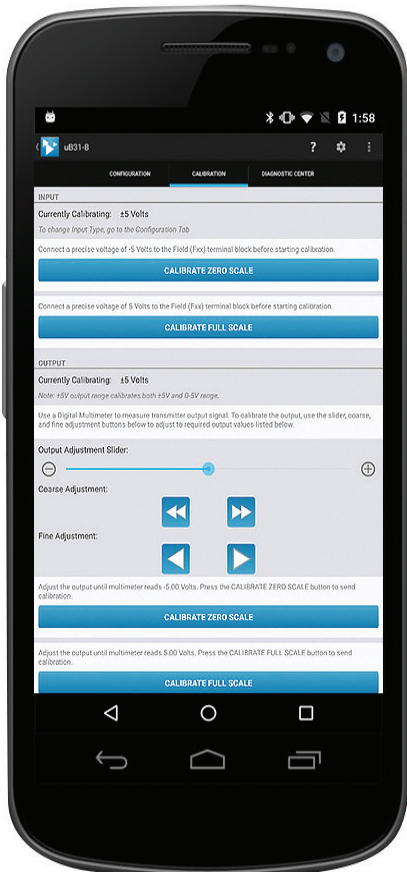

Data Logging



Diagnostics

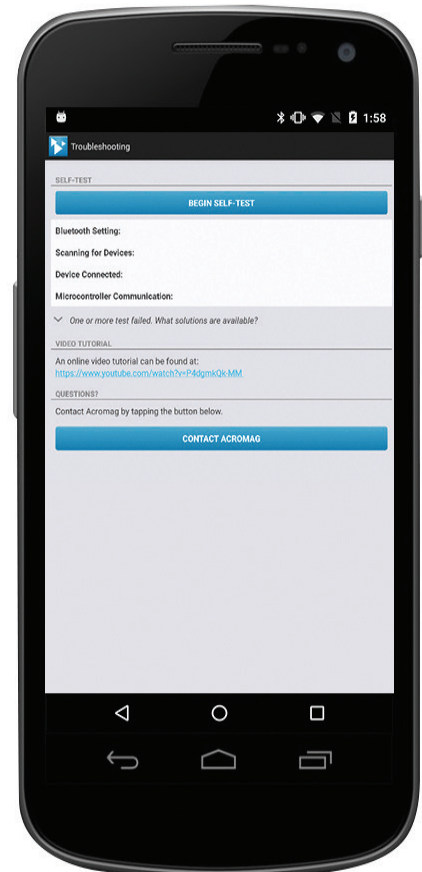

Transmitters: TT Series

Acromag Agility™ Config Tool Mobile Application

The Agility™ Config Tool is a mobile application that allows easy setup and configuration of Acromag TT Series transmitters via a tethered mobile device.

This free app is available for Android devices at the Google Play store at [Acromag Agility™ Config Tool](#).

Demo the software, no need for a module. To enter demo mode simply tap the  icon in the upper left corner 8 times.

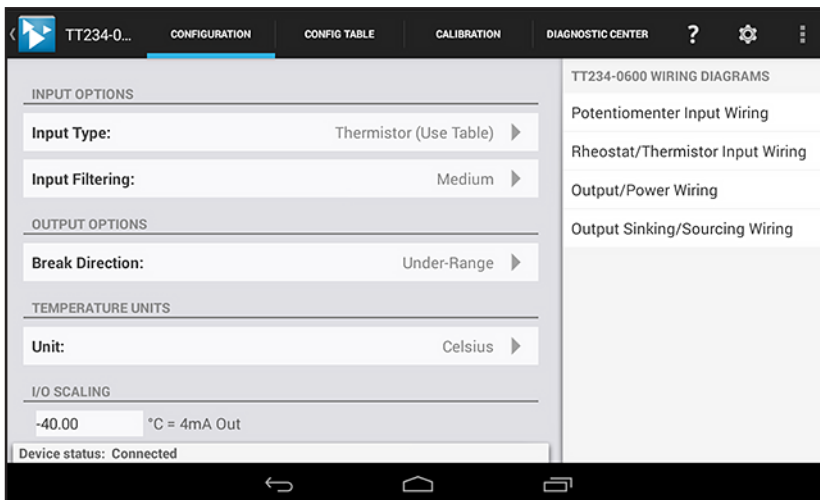
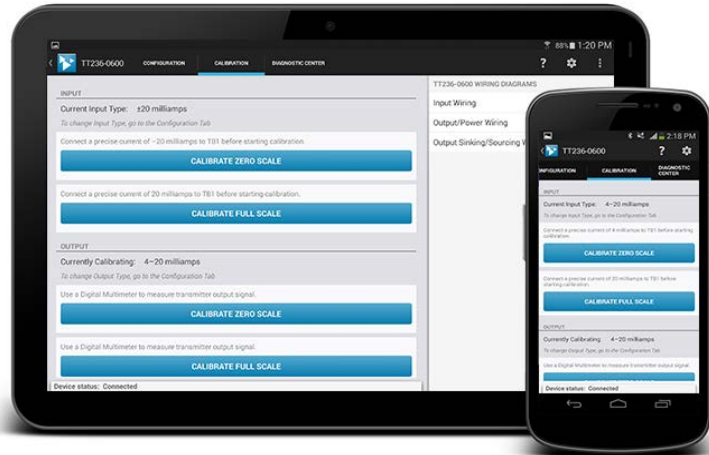

With a couple of taps, quickly configure input, output, unit and scaling options.

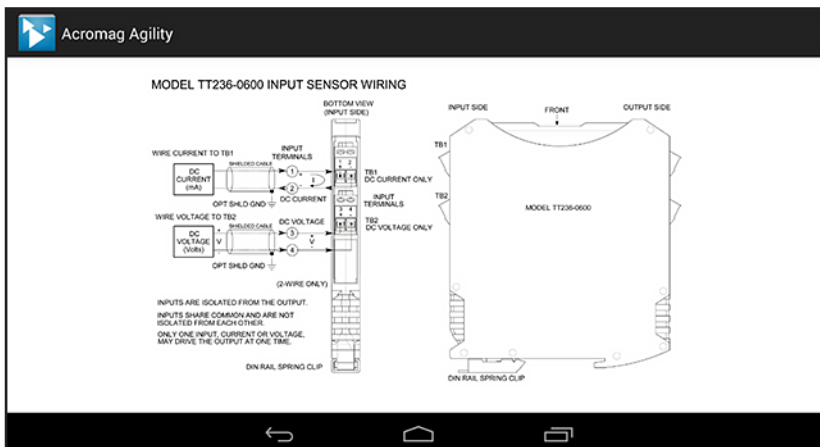

Quick and easy access to the wiring diagram, even offline without internet access.

Key Features & Benefits

- Connects to Acromag TT Series transmitters (except models TT231)
- Requires the use of USB OTG Cable (Acromag part #: 5028-565) and USB A to Mini B Cable (Acromag part #: 4001-113)
- Configures and calibrates TT Series products via phone or tablet running Android 4.3 ICS (Ice Cream Sandwich) or later.
- View wiring diagrams, even without an internet connection
- Perform quick and easy field diagnostics and troubleshooting
- Ideal for field technicians

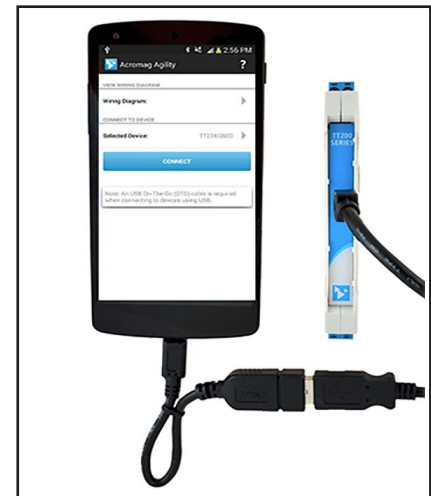

Acromag 
THE LEADER IN INDUSTRIAL I/O

Signal Splitters: SPx30 Series

Acromag Agility™ Config Tool Mobile Application

The Agility™ Config Tool is a mobile application that allows easy setup and configuration of Acromag SP Series signal splitters via a tethered mobile device.

This free app is available for Android devices at the Google Play store at [Acromag Agility™ Config Tool](#).

Demo the software, no need for a module. To enter demo mode simply tap the  icon in the upper left corner 8 times.

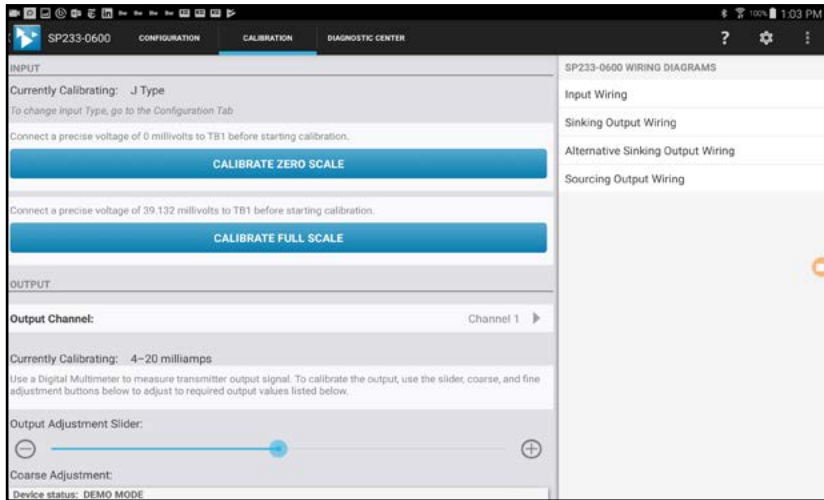
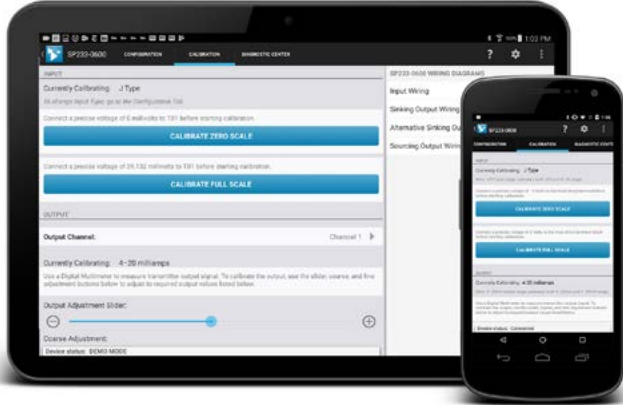

With a couple of taps, quickly configure input, output, unit and scaling options.

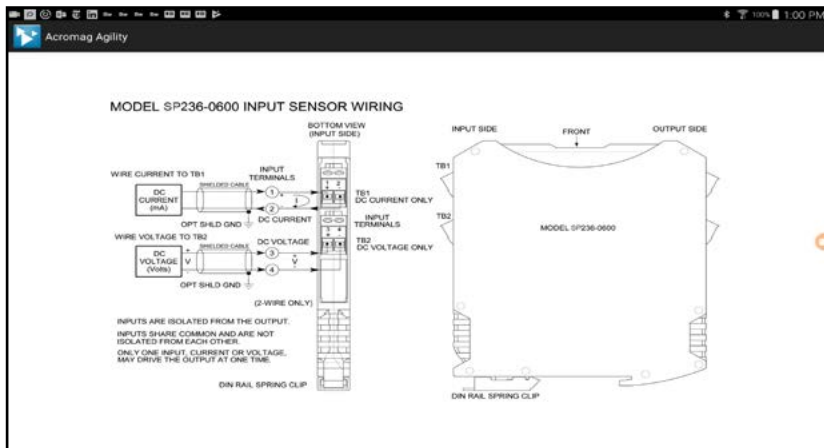

Quick and easy access to the wiring diagram, even offline without internet access.

Key Features & Benefits

- Connects to Acromag SP230 and SP330 Series signal splitters
- Requires the use of USB OTG Cable (Acromag part #: 5028-565) and USB A to Mini B Cable (Acromag part #: 4001-113)
- Configures and calibrates SP230 and SP330 Series products via phone or tablet running Android 4.3 ICS (Ice Cream Sandwich) or later.
- View wiring diagrams, even without an internet connection
- Perform quick and easy field diagnostics and troubleshooting
- Ideal for field technicians



Acromag 
THE LEADER IN INDUSTRIAL I/O